

CATALOGO LISTINO

2020

cilli

www.cillisrl.com



cilli

Dal 1984 con passione ed innovazione proponiamo prodotti che rendono più efficiente il lavoro nei settori agricoltura, giardinaggio e ferramenta. La nostra offerta comprende prodotti realizzati direttamente da noi, accanto ad articoli dei migliori e più affidabili fornitori sul mercato.

I Nostri Marchi

cilli

W BURG
WWW.BURG.TOOLS

CILLITEK III



ITEM 3000000 (KF-11)
TROLLEY IRRO 16 LT BATTERIA
QTY: 1 PCS
N.W.: 9.5KGS
G.W.: 16 KGS
MEAS: 38X27X5 CM

ITEM 3000000 (KF-11)
TROLLEY IRRO 16 LT BATTERIA
QTY: 1 PCS
N.W.: 9.5KGS
G.W.: 16 KGS
MEAS: 38X27X5 CM

ITEM 3000000 (KF-11C-11)
TROLLEY IRRO 16 LT BATTERIA
QTY: 1 PCS
N.W.: 9.5KGS
G.W.: 16 KGS
MEAS: 38X27X5 CM
IMPORTATO DA CILLITEX ITALIA
MADE IN P.R.C.

ITEM 3000000 (KF-11C-11)
TROLLEY IRRO 16 LT BATTERIA
QTY: 1 PCS
N.W.: 9.5KGS
G.W.: 16 KGS
MEAS: 38X27X5 CM
IMPORTATO DA CILLITEX ITALIA
MADE IN P.R.C.

cilli

KÄRCHER

NO 5

CILLITEX

KÄRCHER

NO 5

CILLITEX

NO 5

cilli

LA NOSTRA AZIENDA



SPEDIZIONI

Le consegne vengono garantite servendoci dei migliori vettori nazionali, spedizioni in 24 ore



RETE DI VENDITA

CILLI distribuisce i propri prodotti affidandosi ad una rete vendite composta da agenti professionisti attraverso grossisti, garden center, ferramenta, brico center, supermercati ed ipermercati rivenditori specialisti, internet shop



TERRITORIO

CILLI vanta una consolidata e capillare presenza su tutto il territorio nazionale, in Europa e nel bacino mediterraneo



10.000 mq
Superficie logistica



20.000
Referenze in pronta consegna



**PASSIONE
PRODOTTO
SERVIZIO**



Catalogo On-line



Visita il nostro
sito internet
www.cillisrl.com



Assistenza

Per qualunque problema sui nostri prodotti, si prega di compilare il modulo presente nella sezione assistenza del nostro sito e inviarlo all'indirizzo mail: ordini@cillisrl.it

Per assistenza chiamare

nei seguenti orari: 16:00-17:30
Tel. 0873 547570 Fax. 0873 341884



CILLI SRL
Uffici e Magazzini: Viale Australia,11
66050 San Salvo (CH) - ITALY



cilli

cilli

Settori

Nuovi arrivi

NUOVI
ARRIVI

Irrorazione



Potatura e taglio



Agri e garden



Macchine agri e garden



Irrigazione



Raccolta olive



Enologia



Zootecnia



Pet



Disinfestazione



Antinfortunistica



Ferramenta



Casalinghi





IRRORAZIONE



POMPA IRRORATRICE BATTERIA AL LITIO

La nuova pompa al batteria a Litio è più leggera, ha una maggiore durata e resistenza alle cariche. Potenza del getto costante, fino a fine carica.

LANCIA
TELESCOPICA
IN OTTONE
DA 52 A 100cm

BATTERIA LITIO
RICARICABILE
12V

AUTONOMIA
4/5 h

CARICA
BATTERIA
INCLUSO

CAPACITÀ
16 Lt.



Schienale morbido ed ergonomico



In dotazione



Porta lancia



Interruttore regolatore di potenza e presa carica batteria



Indicatore di carica

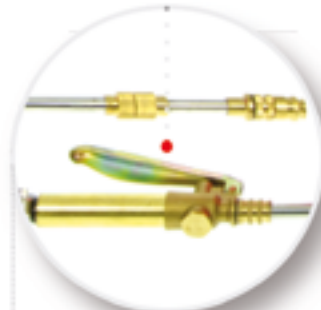

Lancia telescopica in ottone con ugello regolabile



POMPA SPALLEGGIATA A BATTERIA LITIO 16 LT BURG PRO

• Pompa irroratrice spallaggiata con batteria al LITIO ideata per rendere più agevole il lavoro.

Struttura innovativa ed unica nel suo genere completa di sistema schiena-asciutta che evita fastidiosi gocciolamenti sul retro della pompa incanalando eventuali perdite verso la parte anteriore.

PRO

Articolo	€ Listino	
3000020	132,00	1

CARATTERISTICHE	
Tipo	Pompa a batteria LITIO
Dimensioni	390x180x460mm
Capacità del serbatoio	16 Litri
Temperatura max	55° C
Lunghezza tubo	125 cm
Lancia telescopica	52-101cm
Batteria	12V 8Ah
Caricabatteria Input	AC110-245V
Output	DC 12,6V
Potenza elettrica	12v 35w dc
Pressione massima	1,5-4 Bar
Capacità getto singolo	1,5-1,6 l/min
Capacità getto doppio	1,8-3 l/min
Peso netto pompa	3,2 kg



Schienale morbido ed ergonomico



Porta lancia



Sistema schiena-asciutta



Regolatore di potenza e spinotto carica batteria



Ugelli, OR e adattatore ugelli in dotazione

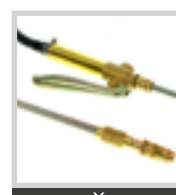

Lancia telescopica in ottone 58-100 cm

cilli

Assistenza certificata • Garantito 2 anni
DISPONIBILI TUTTI I PEZZI DI RICAMBIO



POMPA A ZAINO SPALLEGGIATA A BATTERIA 16 LT

Ideata per rendere più agevole il lavoro. Struttura innovativa ed unica nel suo genere. Sicura ed efficace. Ideale per l'irrorazione ed il diserbo di orti, piante, serre, giardini ecc.

CAPACITÀ
16 Lt.

BATTERIA
RICARICABILE
12V 8Ah

AUTONOMIA
5 h

CODICE: 3000040



Indicatore di carica

- Getto regolabile in ottone
- Lancia telescopica in ottone 55-100 cm
- Impugnatura a leva in ottone



Sistema schiena-asciutta
Evita fastidiosi gocciolamenti
in caso di rabbocchi errati



Schiena morbida ed ergonomica
Cinte zaino imbottite



Carica batteria incluso
Potenza regolabile



Filtro anti impurità



In dotazione 6 tipi di ugelli



Adattatore ugelli incluso

OPTIONAL:



**CARRELLO
MULTIUSO
ACCIAIO ZINCATO**
CODICE 9702000



**CAMPANA DA
DISERBO
GRANDE 36 cm**
CODICE 3005015

cilli

**POMPA SPALLEGGIATA
A BATTERIA 16 LT CILLI**

• Pompa irroratrice spallaggiata con batteria ideata per rendere piú agevole il lavoro. Struttura innovativa ed unica nel suo genere completa di sistema schiena-asciutta che evita fastidiosi gocciolamenti sul retro della pompa incanalando eventuali perdite verso la parte anteriore.

PRO

Articolo	€ Listino	
3000040	110,00	1

CARATTERISTICHE

Tipo	Pompa a batteria
Dimensioni	390x180x460mm
Capacità del serbatoio	16 Litri
Temperatura max	55° C
Lunghezza tubo	125 cm
Lancia telescopica	52-101cm
Batteria	12V 8Ah
Caricabatteria Input	AC110-245V
Output	DC 12,6V 1,2A
Potenza elettrica	12v 35w dc
Pressione massima	1,5-4 Bar
Capacità getto singolo	1,5-1,6 l/min
Capacità getto doppio	1,8-3 l/min
Peso netto pompa	5,4 kg



Ugelli, OR e adattatore ugelli in dotazione



Lancia telescopica in ottone 58-100 cm con ugello regolabile

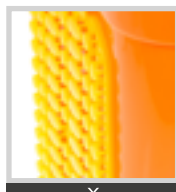

Schiena morbido ed ergonomico



Porta lancia



Sistema schiena-asciutta



Regolatore di potenza e spinotto carica batteria

cilli

KIT POMPA CARRELLATA 16 LT BATTERIA

- Kit composto da carrello + pompa a batteria 3000040.
- Carrello in acciaio zincato.
- Ruote piene antiforo.

Articolo	Lcm	€ Listino	
3000038	36x20xh98	215,00	1



Sistema 2 di bloccaggio pompa.



Ruote antiforo piene.



Reggi asta.

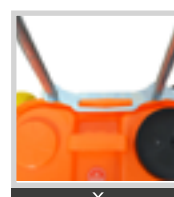

Sistema 1 di bloccaggio pompa.



**POMPA SPALLEGGIATA
A BATTERIA 16 LT IRROR**

CARATTERISTICHE

Tipo	Pompa a batteria
Capacità del serbatoio	16 Litri
Temperatura max	55° C
Lunghezza tubo	125 cm
Lancia telescopica	52-100cm
Batteria	12V 8Ah
Potenza elettrica	12v 35w dc
Pressione massima	1,5-4 Bar
Capacità getto singolo	1,5-1,6 l/min
Capacità getto doppio	1,8-3 l/min

Articolo	€ Listino	
3000090	79,00	1



Schienale morbido ed ergonomico con cinghie imbottite e regolabili



Indicatore di carica

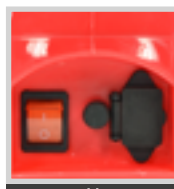

Regolatore di potenza e pulsante di accensione



Ugelli, OR, adattatore ugelli e caricabatterie in dotazione



Lancia telescopica 52-100 cm con ugello in ottone e blocco a leva



Porta lancia



TROLLEY IRRORAZIONE BATTERIA 16 LT BURG

• Pompa irroratrice spalleggiata con batteria ideata per rendere più agevole il lavoro, grazie anche al carrellino in dotazione.

PRO

Articolo	€ Listino	
3000000	100,00	1

CARATTERISTICHE

Tipo	Pompa a batteria
Dimensioni	360x280x790/1000mm
Capacità del serbatoio	16 Litri
Temperatura max	35° C
Lunghezza tubo	200 cm
Lancia telescopica	65-98cm
Batteria	12V 8Ah
Caricabatteria Input	AC100-220V
Output	DC 12,6V
Potenza elettrica	12v 35w dc
Pressione massima	3,0-4,0 Bar
Capacità getto singolo	1,5-1,6 l/min
Capacità getto doppio	1,8-3 l/min
Peso netto pompa	5,4 kg



Uso Trolley



Uso a spalla



Porta lancia



Regolatore di potenza e spinotto carica batteria



Ugelli, OR e adattatore ugelli in dotazione



Lancia telescopica in ottone 65-98 cm

RICAMBI POMPA A BATTERIA 3000020



3000040



3000090



UBURG
PUMP, BATTERY TOOLS
PROFESSIONAL

INTERRUTTORE



Articolo	€ Listino	
3000064	3,80	3

UBURG
PUMP, BATTERY TOOLS
PROFESSIONAL

INTERRUTTORE ACCENSIONE VELOCITA'



Articolo	€ Listino	
3000071	8,00	3

UBURG
PUMP, BATTERY TOOLS
PROFESSIONAL

SENSORE INTERRUTTORE POMPA



Articolo	€ Listino	
3000044	4,20	3

UBURG
PUMP, BATTERY TOOLS
PROFESSIONAL

VOLTOMETRO



Articolo	€ Listino	
3000061	4,50	3

UBURG
PUMP, BATTERY TOOLS
PROFESSIONAL

TAPPO E CESTINO



Articolo	€ Listino	
3000074	3,00	4

UBURG
PUMP, BATTERY TOOLS
PROFESSIONAL

SET UGELLI PER LANCIA



Articolo	€ Listino	
3000049	6,20	30

UBURG
PUMP, BATTERY TOOLS
PROFESSIONAL

TUBO LANCIA IMPORT



Articolo	Lcm	€ Listino	
3000047	125	3,70	1

UBURG
PUMP, BATTERY TOOLS
PROFESSIONAL

SET 2 CINGHIE



Articolo	€ Listino	
3000068	5,00	10

UBURG
PUMP, BATTERY TOOLS
PROFESSIONAL

POLVERIZZATORE OTTONE REGOLABILE



Articolo	€ Listino	
0190350	1,22	24

UBURG
PUMP, BATTERY TOOLS
PROFESSIONAL

SET LANCIA TELESCOPICA OTTONE



Articolo	Lcm	€ Listino	
0190057	58-103	16,40	12

• Raccordo portagomma doppio: 8-10.
Getto regolabile in dotazione.

Per informazioni tecniche, foto e prezzi aggiornati visita il nostro sito www.cillisrl.com

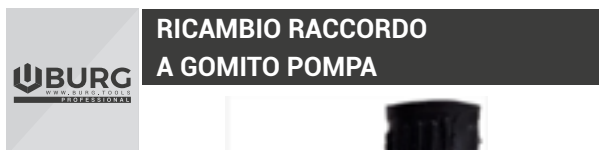

Articolo	€ Listino	
3000095	1,60	1

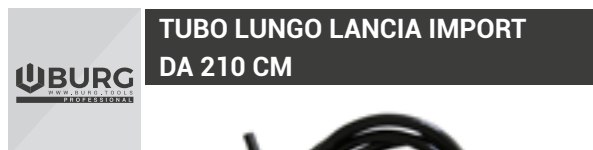

Articolo	€ Listino	
3000072	7,50	1

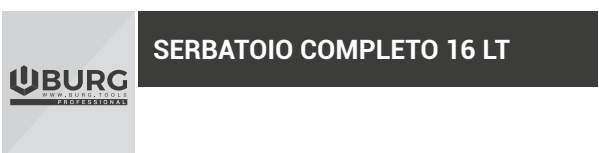

Articolo	€ Listino	
3000091	18,00	1

RICAMBI POMPA A BATTERIA 3000020



Articolo	€ Listino	
3000022	14,00	1



Articolo	€ Listino	
3000023	70,00	3

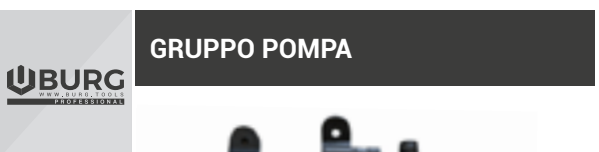

Articolo	€ Listino	
3000043	26,00	3

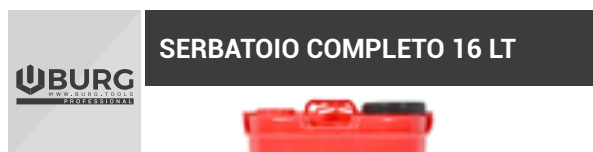

Articolo	€ Listino	
3000025	20,00	1

RICAMBI POMPA A BATTERIA 300040



CARICABATTERIA RICAMBIO



Articolo	€ Listino	
3000067	12,00	1



BATTERIA RICAMBIO 12 VOLT 8AH



Articolo	€ Listino	
3000062	31,00	3



GRUPPO POMPA



Articolo	€ Listino	
3000043	26,00	3



SERBATOIO COMPLETO 16 LT



Articolo	€ Listino	
3000045	20,00	1

RICAMBI POMPA A BATTERIA 300090



CARICABATTERIA RICAMBIO



Articolo	€ Listino	
3000092	12,00	10



BATTERIA RICAMBIO 12 VOLT 8AH



Articolo	€ Listino	
3000062	31,00	3



GRUPPO POMPA



Articolo	€ Listino	
3000094	26,00	3

RICAMBI POMPA A BATTERIA 300000



Articolo	€ Listino	
3000092	12,00	10

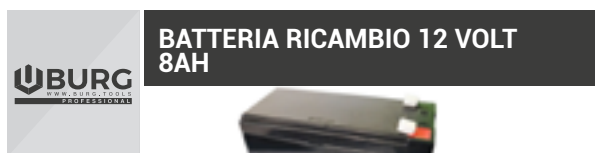

Articolo	€ Listino	
3000062	31,00	3

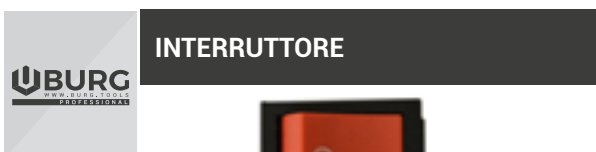

Articolo	€ Listino	
3000064	3,80	1



Articolo	€ Listino	
2999964	5,00	1

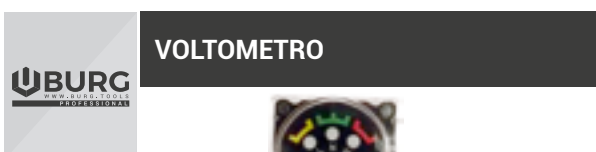

Articolo	€ Listino	
3000061	4,50	1

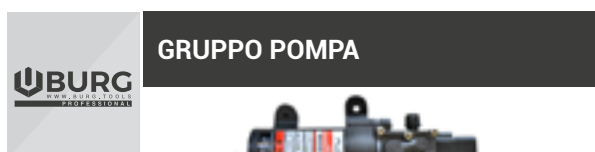

Articolo	€ Listino	
2999972	33,00	3

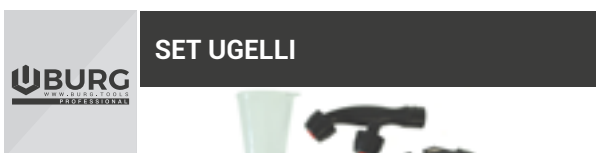

Articolo	€ Listino	
2999950	4,00	1

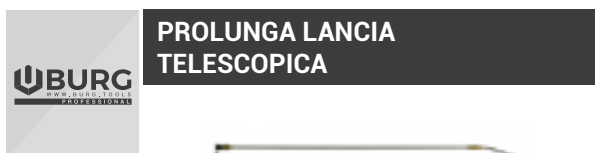

Articolo	€ Listino	
2999952	10,00	3



Articolo	€ Listino	
2999956	2,00	1

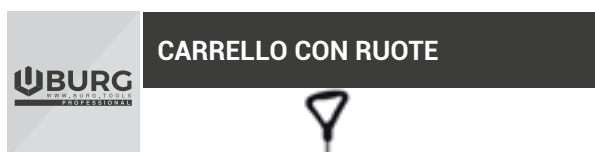

Articolo	€ Listino	
2999970	40,00	1

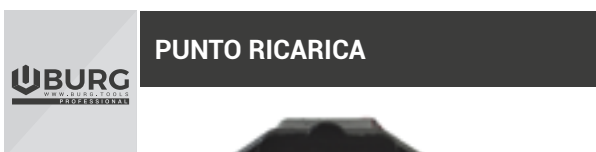

Articolo	€ Listino	
2999966	4,60	1

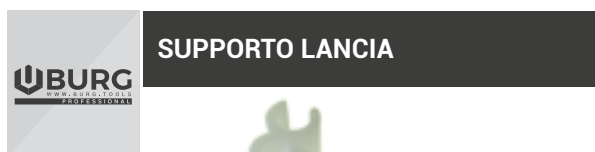

Articolo	€ Listino	
2999974	1,80	1

cilli

**POMPA CARRELLATA
A BATTERIA 45 LT**

• Pompa carrellata per trattamenti di irrorazione di prodotti antiparassitari, diserbo chimico e per la distribuzione di concimi liquidi in soluzione. Per trattamenti di irrorazione di serre, giardini, aiuole e orti e per la disinfezione di ambienti sia aperti che chiusi. Pompa fornita con avvolgitubo, tubo 25 metri e lancia a leva da 90 cm.

PRO

Articolo	€ Listino	
3000010	380,00	1

CARATTERISTICHE

Tipo	Pompa a batteria
Dimensioni	900x430x650mm
Capacità del serbatoio	45 Litri
Temperatura max	55° C
Lunghezza tubo	25 mt
Lunghezza lancia	90 cm
Batteria	12V 8Ah
Caricabatteria Input	AC100-220V
Output	DC 12,6V
Potenza elettrica	12v 35w dc
Pressione massima	4,5 Bar
Capacità getto doppio	1,8-3 l/min
Velocità motore	2800-3200 r/min
Tempo di ricarica	10 ore circa



Ruote piene antiforo con cerchio in acciaio



Bocchettone di scarico



Avvolgitubo e tubo in dotazione



Regolatore di potenza, spinotto, voltmetro e carica batteria



Caricabatterie, ugelli, OR e adattatore ugelli in dotazione



Lancia alluminio da 90 cm

Per informazioni tecniche, foto e prezzi aggiornati visita il nostro sito www.cillisrl.com



POMPA IRRO 16 POMPANTE IN OTTONE 16 LT



Articolo	€ Listino	
3004210	59,00	6
3000075 Pompante ricambio	24,00	3

• Ugelli in omaggio. Lancia in ottone

CARATTERISTICHE

Lancia in metallo	70cm
Lunghezza tubo	125cm
Max gittata	Ugello singolo 1,25 l/min; Ugello doppio 2,0 l/min; Ugello 4 fori 2,0 l/min.
Temperatura max	55°C
Pressione max	2,5-4,5 bar
Lunghezza impugnatura lancia	20 cm
Diametro Lancia	10 mm
Diametro attacco filetto lancia	13 mm
Diametro interno e esterno tubo	6-12 mm
Peso a vuoto	4 kg



POMPA IRRO 16 POMPANTE IN NYLON 16 LT



Articolo	€ Listino	
3004125	37,00	6
3000080 Pompante ricambio	10,00	3

• Ugelli in omaggio

CARATTERISTICHE

Lancia in nylon	70cm
Lunghezza tubo	125cm
Max gittata	Ugello singolo 1,25 l/min; Ugello doppio 2,0 l/min; Ugello 4 fori 2,0 l/min.
Temperatura max	55°C
Pressione max	2,5-4,5 bar
Lunghezza impugnatura lancia	20 cm
Diametro Lancia	22 mm
Diametro attacco filetto lancia	13 mm
Diametro interno e esterno tubo	6-12 mm
Peso a vuoto	4 kg





TAPPO E CESTINO RICAMBIO



Articolo	€ Listino	
3000069	3,00	10

• Ricambio per 3004210-3004125



KIT RICAMBI STANTUFFO + O.R. + GUARNIZIONI



Articolo	€ Listino	
3000042	4,64	10

• Ricambio per 3004210-3004125



POMPA PRECOMPRESSIONE 8 LT



Articolo	€ Listino	
3003990	23,00	6



POMPA PRECOMPRESSIONE 5 LT



Articolo	€ Listino	
3003980	21,00	6



POMPA PRECOMPRESSIONE 2 LT



Articolo	€ Listino	
3003450	7,90	20



POMPA PRECOMPRESSIONE 2 LT CON MANOMETRO



Articolo	€ Listino	
3003452	9,00	12

• Dotata di comoda impugnatura e di un pratico pomello per agevolare il pompaggio.
Con valvola di sfiato di sicurezza per scaricare la pressione eccessiva. Ugello regolabile ottone

Per informazioni tecniche, foto e prezzi aggiornati visita il nostro sito www.cillisrl.com

cilli

POMPA PRECOMPRESSIONE 1 LT



Articolo	€ Listino	
3003940	5,00	30

cilli

POMPA VAPORIZZATRICE 1 LT IN BOX ESPOSITORE



Articolo	€ Listino	
3004030	3,00	75
3004035	Testa vaporizzatrice 0,60	120

cilli

LANCIA VAPORIZZATRICE PER BOTTIGLIE



Articolo	€ Listino	
3003910	1 Getto 10,80	24
3003915	2 Getti 11,00	24

ORIGINALE
VOLPI

POMPA PER RAME A LEVA AUTORIEMPIENTE IN OTTONE



Articolo	€ Listino	
3000400	116,80	2
3000410	Stantuffo 9,60	2

DAL DEGAN
1870

POMPA RAME 16 LT



Articolo	€ Listino	
3006040	143,10	1



POMPA RAME 16 LT UNI SX COMPLETA



Articolo	€ Listino	
3000200	162,00	1



CILLI TEK III

POMPA NOVAIRRO 16 OTTONE



Articolo	€ Listino	
3004116	61,95	6
3004118 Pompante in ottone	38,40	3

CARATTERISTICHE

Serbatoio in polietilene	16 Lt
Pompante	in ottone
Diametro pompante	44 mm
Tubo flessibile in PVC	120 cm
Lancia con pulverizzatore	in ottone regolabile
Pressione	6 Bar
Pompa	ambidestra
Spallacci	regolabili
Guarnizioni speciali in	NBR
Peso netto	3,15 Kg

CILLI TEK III

POMPA NOVAIRRO 16 NYLON



Articolo	€ Listino	
3004016	44,60	6
3004119 Pompante in nylon	23,60	3

CARATTERISTICHE

Serbatoio in polietilene	16 Lt
Pompante	in plastica con agitatore idraulico
Tubo flessibile in PVC	120 cm
Lancia con pulverizzatore	in ottone regolabile
Pressione	6 Bar
Pompa	ambidestra
Spallacci	regolabili
Guarnizioni speciali in	NBR
Peso netto	3,15 Kg

CILLI TEK III

POMPA NOVAIRRO 12 OTTONE



Articolo	€ Listino	
3004112	72,50	6
3004118 Pompante in ottone	38,40	3

CILLI TEK III

POMPA NOVAIRRO 12 NYLON



Articolo	€ Listino	
3004012	42,80	6
3004119 Pompante in nylon	23,24	3

CILLI TEK III

POMPA PRECOMPRESSIONE NOVAIRRO 8 LT



Articolo	€ Listino	
3004250 Pompante	31,10	6
3004255	18,00	3

CILLI TEK III

POMPA PRECOMPRESSIONE NOVAIRRO 6 LT



Articolo	€ Listino	
3004260	30,20	6
3004255 Pompante	18,00	3

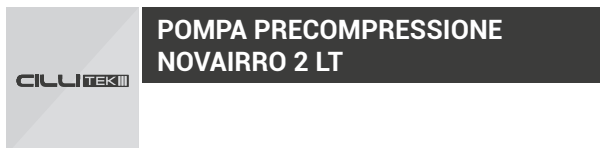

Articolo	€ Listino	
3004060	9,90	10
3004062	Kit ricambi 5,50	10



Articolo	€ Listino	
3004080	10,10	10

Valvola di scarico pressione; Funziona anche a testa in giù; Ugello orientabile in tutte le direzioni. Colori non a scelta

CARATTERISTICHE	
Capacità totale serbatoio	2 Lt
Capacità operativa	1,8 Lt
Serbatoio	in PET trasparente
Pressione	2 Bar
Impugnatura	ergonomica
Colori	assortiti
Guarnizioni	in NBR
Ugello	in ottone regolabile ed orientabile
Valvola	di scarico pressione
Peso netto	0,46 kg circa
Adatta	per irrorazione di piante e per usi domestici

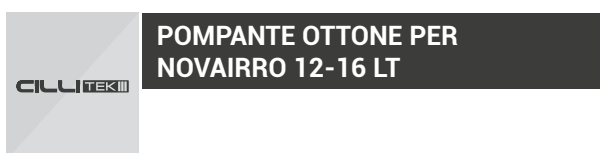

Articolo	€ Listino	
3004118	38,40	3

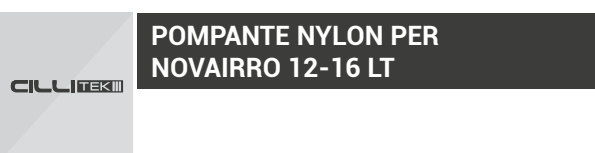

Articolo	€ Listino	
3004119	23,60	3



Articolo	€ Listino	
3004255	18,00	3



Articolo	€ Listino	
3004140	1,46	12

CILLI TEK III

VALVOLA TENUTA PER NOVAIRRO 12-16 LT



Articolo	€ Listino	
3004150	1,58	12

MICRONIZZATORE A BATTERIA



Articolo	€ Listino	
3005150	36,00	2

• Funziona con normali batterie del tipo C (Mezza torcia)

MICRONIZZATORE M3000 CON CAMPANA



Articolo	Lt	Kg	€ Listino	
3006075	1	2	128,50	2

• Il micronizzatore elettrico con campana di 34 cm è una macchina funzione con 2 batterie da 1,5 Volt la cui durata è di circa 40 ore.

MICRONIZZATORE M10V JOLLY



Articolo	Lt	Kg	€ Listino	
3006080	10	1,70	99,60	2

• Il micronizzatore produce gocce regolari della dimensione di 250 micron e funziona con 2 batterie da 1,5 Volt, la cui durata è di 40 ore.

SOLFORATRICE ELETTRICA DINAMICA



Articolo	Capacità	Kg	€ Listino	
3006070	6 Kg	8	398,00	1
3006061	Caricabatterie ricambio		47,00	1
3006062	Canna con spandizolfo		6,80	1
3006063	Canna prolungamento		5,80	1
3006064	Tubo spiralato mandata		19,20	1

• Utilizzabile anche con altre polveri e microgranuli.

CARATTERISTICHE

Pompa SVE	con girante centrifuga
Alimentazione Batteria al piombo	ricaricabile 12V DC 7Ah
Motore elettrico	31,2 Watt - 12 V
Batteria al litio ricaricabile	12V DC 8 Ah 96 Watt
Portata massima (aria)	28 lit/sec
Portata massima (polvere) (*)	0,3 kg/min
Capacità serbatoio	6 Kg
Autonomia	6/7 serbatoi
Lunghezza tubo mandata	0,6 + 0,6 mt
Diametro bocca riempimento	115 mm
Gruppo valvola regolabile	A 5 posizioni
Peso netto della pompa	8 kg
Dimensioni pompa	43 x 34 x 59 cm
Peso a vuoto della solforatrice con batteria	6,6 Kg

SOLFORATRICE A ZAINO SV80

• E' costruita con telaio in acciaio verniciato e serbatoio in polietilene alta densità. Funziona con un gruppo trituratore a disco rotante con regolatore delle polveri in 5 posizioni.



Articolo	Capacità Kg	€ Listino	
3006060	6 Kg	1,70 198,00	1

SOLFORATRICE A ZAINO LEVA SX

• Solforatrice a spalla con azionamento manuale, adatta per trattamenti antiparassitari con polvere di zolfo e prodotti microgranulari.

Un dispositivo di miscelazione del prodotto favorisce uno svuotamento completo del serbatoio. Caratteristica funzionale è il mantice con azionamento a doppio effetto; questo assicura minore fatica di lavoro, un flusso costante dell'aria e conseguentemente una distribuzione uniforme del prodotto.



Articolo	Capacità	€ Listino	
3006050	5 Kg	130,56	1

SOFFIETTO POLVERI EOLO IN PLASTICA



Articolo	Capacità Kg	€ Listino	
3006090	0,6 Kg	0,16 9,50	12

CAMPANA PRO DISERBO GRANDE



Articolo	€ Listino	
3005050	12,60	12

• Filetto 12x19. Raccordo curvo in ottone. Filetto italiano.



SOFFIETTO POLVERI CON TRITURINO



Articolo	€ Listino	
3006020	28,00	8

CAMPANA DISERBO GRANDE



Articolo	Lmm	€ Listino	
3005015	360	8,00	12

• Filetto italiano.

ADATTATORE LANCIE FILETTO ITALIANO PER CAMPANA DISERBO



Articolo	€ Listino	
3005016	1,70	12

• Filetto import 12x1,5. Questo adattatore serve per utilizzare le lance irrorazione italiane sulle campane diserbo import.

LANCIA METALLO IMPUGNATURA IN PLASTICA CON MANOMETRO



Articolo	Lcm	€ Listino	
3000088	72	17,85	12

LANCIA LEVA ALLUMINIO REGOLABILE



Articolo	Lcm	€ Listino	
0190075	54	9,30	12

LANCIA LEVA ALLUMINIO REGOLABILE



Articolo	Lcm	€ Listino	
0190080	62	8,00	12

LANCIA LEVA NYLON CON TUBO



Articolo	Lcm	€ Listino	
3000065	70	6,20	10

ASTA TELESCOPICA RICAMBIO IRRO 18



Articolo	Lcm	€ Listino	
3007018	65-117	5,60	12

LANCIA TELESCOPICA ALLUMINIO CON RACCORDI IN OTTONE



Articolo	Lcm	€ Listino	
3004275	58-100	13,30	12

SET LANCIA ALLUMINIO TELESCOPICA CON RACCORDI IN OTTONE



Articolo	Lcm	€ Listino	
3000066	52-101	15,40	12

• Lunghezza tubo: 210 cm

Per informazioni tecniche, foto e prezzi aggiornati visita il nostro sito www.cillisrl.com

LANCIA IRRO OTTONE TELESCOPICA



Articolo	Lcm	€ Listino	
0190057	58-100	16,40	12
0190350	Ugello per lancia	1,22	24

- Raccordo doppio da: 8-10 mm
- Ugello regolabile

LANCIA A LEVA BASSA PRESSIONE OTTONE COMPLETA DI GETTO



Articolo	Lmm	kg	€ Listino	
0190060	680	0,300	15,22	12

- Raccordo 10 mm
- Ugello regolabile

LANCIA A FARFALLA BASSA PRESSIONE OTTONE COMPLETA DI GETTO



Articolo	Lmm	kg	€ Listino	
0190030	680	0,250	13,70	12

- Raccordo 10 mm
- Ugello regolabile

PROLUNGA ATTACCO M+F CURVA IN OTTONE



Articolo	Lmm	kg	€ Listino	
0190680	500	0,090	3,96	12

PROLUNGA ATTACCO M+F IN OTTONE



Articolo	Lmm	kg	€ Listino	
0190693	300	0,065	3,04	12
0190690	465	0,085	3,98	12
0190697	700	0,115	4,90	12
0190699	1000	0,150	6,40	12

PROLUNGA TELESCOPICA ATTACCO M+F IN OTTONE



Articolo	Lmm	kg	€ Listino	
0190685	500-1000	0,140	8,35	12
0190686	750-1500	0,180	9,04	12

IMPUGNATURA CON MANOMETRO



Articolo	Lmm	€ Listino	
3000087	170	7,76	24

IMPUGNATURA CON RUBINETTO IN OTTONE A LEVA



Articolo	Lmm	kg	€ Listino	
0190220	160	0,140	10,54	12

- Raccordo 10 mm. 25 ATM

**IMPUGNATURA CON RUBINETTO
IN OTTONE A LEVA CON FERMO**



Articolo	Lmm	kg	€ Listino	
0190230	140	0,140	11,96	12

• Attacco 1/2" M. 25 ATM
Completa di filtro a rete

IMPUGNATURA PORTAFILTRO



Articolo	Lmm	kg	€ Listino	
0190210	110	0,025	5,70	12

• 25 ATM

FILTRO CON RUBINETTO A SFERA



Articolo	Lmm	kg	€ Listino	
0190200	165	0,144	8,84	12

• Raccordo 10 mm. 25 ATM

FILTRO CON RUBINETTO



Articolo	Lmm	kg	€ Listino	
0190205			8,84	12

RETICELLA PER FILTRO



Articolo	Lmm	kg	€ Listino	
0190250	75	0,005	0,76	12

• 25 ATM
Reticella per filtro necessaria per trattenere le impurità che dovessero essere presenti all'interno del liquido che si sta adoperando con la pompa a bassa pressione.

**RUBINETTO A FARFALLA
M - 1/4"**



Articolo	kg	€ Listino	
0190660	0,050	3,66	12

• Raccordo 10 mm. 25 ATM
Impugnatura lancia pompa irro.

**RUBINETTO A FARFALLA
M - M**



Articolo	Lmm	kg	€ Listino	
0190650	75	0,005	4,50	12

• Attacchi 10 mm

**PORTAGOMMA DRITTO
FEMMINA**



Articolo	Ø	€ Listino	
0113070	10	2,80	24

Per informazioni tecniche, foto e prezzi aggiornati visita il nostro sito www.cillisrl.com

RIDUZIONE ADATTATORE F - M



Articolo	€ Listino	
0190365	2,80	48

• Da fileto import a fileto italiano

RIDUZIONE ADATTATORE F - M



Articolo	€ Listino	
0190367	3,00	48

• Da fileto italiano a fileto import

GUARNIZIONE PER LANCE E UGELLI



Articolo	€ Listino	
0190800	0,10	100

• O.R. 113 NBR 70 SH 9,92X2,62

PORTAGETTO A GOMITO M-F IN OTTONE



Articolo	Lmm		€ Listino	
0190700	35	0,023	1,18	12

• Da fileto italiano a fileto import

POLVERIZZATORE REGOLABILE IN OTTONE



Articolo	Lmm		€ Listino	
0190300	80	0,095	5,16	12
0190340	Cappelletto ricambio		0,84	12

• Polverizzatore universale regolabile getto in ottone per lancia bassa pressione. Per nebulizzazione a nuvola e nebulizzazione mirata. Diametro 20 mm. Attacco W12 x 19" femmina.

POLVERIZZATORE UNIVERSALE REGOLABILE CORTO IN OTTONE



Articolo	Lmm		€ Listino	
0190330	50	0,055	3,60	12
0190340	Cappelletto ricambio		0,84	12

• Polverizzatore universale regolabile getto in ottone per lancia bassa pressione. Per nebulizzazione a nuvola e nebulizzazione mirata. Diametro 20 mm. Attacco W12 x 19" femmina.

POLVERIZZATORE REGOLABILE IN OTTONE



Articolo	Lmm		€ Listino	
0190350	35	0,025	1,22	24

• Minigetto regolabile getto in ottone per lancia bassa pressione. Per nebulizzazione a nuvola e nebulizzazione mirata. Attacco W12 x 19" femmina.

GETTO ESAGONALE A ROSA IN OTTONE TIPO MERIDIONALE



Articolo	Lmm		Fori	€ Listino	
0190462	35	0,030	2	2,80	24
0190463	35	0,030	3	2,80	24
0190464	35	0,030	4	2,80	24

UGELLO FILETTO IMPORT OTTONE



Articolo	€ Listino	
3000046	2,30	20

• Compatibile anche con pompa: 3004210; 3004125; 3000040

GETTO TRIFORCO COMPLETO DI GETTI CON ELICA IN OTTONE



Articolo	Lmm	kg	€ Listino	
0190600	65	0,100	8,50	12
0190480	Getto di ricambio		0,90	24

• Getto polverizzatore triforco in ottone per lancia a bassa pressione, completo di getti con elica. Attacco W 12 x 19" femmina.

GETTO A SPATOLA ATTACCO 3/8" OTTONE



PRO

Articolo	Lmm	kg	Foro	€ Listino	
0191315	35	0,025	1,5	2,80	12

GETTO ESAGONALE A ROSA IN OTTONE



Articolo	Lmm	kg	Fori	€ Listino	
0190442	23	0,028	2	2,32	24
0190443	23	0,028	3	2,32	24
0190444	23	0,028	4	2,32	24

GETTO BIFORCO COMPLETO DI GETTI CON ELICA IN OTTONE



Articolo	Lmm	kg	€ Listino	
0190540	65	0,070	5,80	12
0190480	Getto di ricambio		0,90	24

• Getto polverizzatore biforco in ottone per lancia a bassa pressione, completo di getti con elica. Attacco W 12 x 19" femmina.

GETTO A VENTAGLIO ATTACCO 3/8" IN OTTONE



PRO

Articolo	Lmm	kg	Foro	€ Listino	
0191108	25	0,025	0,8	3,00	12
0191110	25	0,025	1,0	3,00	12
0191112	25	0,025	1,2	3,00	12
0191115	25	0,025	1,5	3,00	12

• Getto a ventaglio in kematal con attacco femmina W12 x 19" con ugello stampato in Delrin®, ad alta stabilità chimica che conferisce ottime caratteristiche di durata. Raggio d'azione dell'ugello 120°. Adatti per trattamenti eseguiti con pompa a spalla bassa pressione.

GETTO A ROSA CON PIASTRINA RILSAN IN OTTONE



PRO

Articolo	Lmm	kg	€ Listino	
0190450	25	0,025	3,04	24

GETTO A ROSA CON PIASTRINA RILSAN IN OTTONE



Articolo	Lmm	kg	€ Listino	
0190470	20	0,017	1,78	24

CILLITEK III

ROTOLO DA 100 MT TUBO PVC ALTA PRESSIONE

• Tubo in PVC flessibile con rinforzo retinato in poliestere ad alta tenacità. Prodotto con speciale formulazione che conferisce resistenza al passaggio di prodotti chimici utilizzati in agricoltura. Particolarmente resistente alla pressione, all'abrasione e agli agenti atmosferici. Maneggevole e flessibile anche a basse temperature. Applicazioni: irrorazione a pressione di insetticidi, antiparassitari e diserbanti in agricoltura. Idoneo anche al passaggio di aria compressa.



PRO

Articolo	Bar	Ø	€ Listino	
0652008	20	8x13	65,60	1
0652010	20	10x15	87,40	1
0654008	40	8x14	90,70	1
0654010	40	10x16	100,44	1
0658008	80	8x15	131,10	1
0658010	80	10x18	196,60	1

CARATTERISTICHE

	Diametro mm	Lunghezza mt	P.Esercizio-P.Max
CilliTek 20 BAR	8 x 13	100	20 - 60 bar
	10 x 15	100	20 - 60 bar
CilliTek 40 BAR	8 x 14	100	40 - 120 bar
	10 x 16	100	40 - 120 bar
CilliTek 80 BAR	8 x 15	100	80 - 240 bar
	10 x 18	100	80 - 240 bar

LANCIA MITRA DOPPIO TURBO SENZA RACCORDO



Articolo	Raccordo	€ Listino	
0112005		71,80	6
Optional			
0113080	1/2" x Ø 8	1,70	60
0113100	1/2" x Ø 10	1,70	60
0113130	1/2" x Ø 13	1,70	60

• Ugello in dotazione Ø 1,5 / 2,5

LANCIA PISTOLA TURBO SENZA RACCORDO



Articolo	Raccordo	€ Listino	
0111500		50,00	10
Optional			
0113080	1/2" x Ø 8	1,70	60
0113100	1/2" x Ø 10	1,70	60
0113130	1/2" x Ø 13	1,70	60

• Ugello in dotazione Ø 1,5 / 2,5

UGELLO MITRA CONO M15 x 1



Articolo	Ø	€ Listino	
0199110	1,0	2,04	24
0199112	1,2	2,04	24
0199115	1,5	2,04	24
0199118	1,8	2,04	24
0199120	2,0	2,04	24
0199125	2,5	2,04	24
0199130	3,0	2,04	24

• Ugelli adatti per gli articoli:
0112005-0111500-0100320-0100620
0110320-0110620-0111020-0118105

**RACCORDO PORTAGOMMA
DRITTO MASCHIO 1/2"**



Articolo	Ø mm	€ Listino	
0113085	8	1,08	60
0113105	10	1,03	60
0113135	13	1,13	60

GIUNTO SEMPLICE DRITTO



Articolo	Ø mm	€ Listino	
0114180	8	0,88	120
0114190	10	0,88	120
0114200	13	0,88	120

**GIUNTO PORTAGOMMA
3 PEZZI PESANTE**

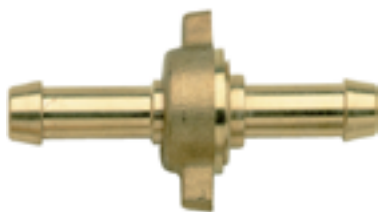

Articolo	Ø mm	€ Listino	
0114080	8	2,90	36
0114100	10	2,90	36
0114110	13	2,90	36

**GIUNTO PORTAGOMMA 90°
CON GHIERA 1/2"**



Articolo	Ø mm	€ Listino	
0113590	8	5,04	24
0113600	10	5,10	24
0113630	13	5,82	24

**GIUNTO A Y 2 MASCHI 1 FEMMINA
1/2"**



Articolo	€ Listino	
0114300	9,60	12

• 1/2"M + 1/2"M+1/2"F

**NIPPLLO DI GIUNZIONE
IN OTTONE**

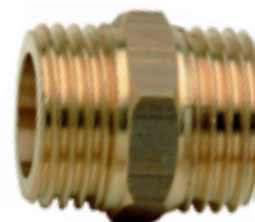

Articolo	Ø	€ Listino	
0114400	3/8" - 1/2"	1,66	12
0114450	1/2" - 1/2"	1,16	12
0500200	1/2" - 24x2	5,00	6

FILTRO ASPIRAZIONE



Articolo	L/min	Ø	€ Listino	
0180500	60	1.1/4"	12,80	12
0180510	100	1.1/4"	15,00	12
0180520	170	1.1/2"	31,64	6

• Corpo in polipropilene. Guarnizioni in EPDM. Inserti di fissaggio in ottone.

FILTRO ASPIRAZIONE MAXI



Articolo	L/min	Ø	€ Listino	
0180522	200	2"	36,75	6

• Corpo in polipropilene. Guarnizioni in EPDM. Inserti di fissaggio in ottone.

GUARNIZIONE PER PORTAGOMMA



Articolo	Lmm	€ Listino	
0113250	18x12x2	0,08	100

RACCORDO PORTAGOMMA CURVO



Articolo	Ø mm	Ghiera	€ Listino	
0180725	25	1.1/4"	1,90	25
0180730	30	1.1/4"	1,90	25
0180735	35	1.1/2"	2,55	25
0180740	40	1.1/2"	2,55	25

RACCORDO PORTAGOMMA DITTO PER GIRELLO



Articolo	Ø mm	Ghiera	€ Listino	
0180525	25	1.1/4"	1,40	25
0180530	30	1.1/4"	1,40	25
0180535	35	1.1/2"	1,75	25
0180540	40	1.1/2"	1,75	25

• Fornito senza ghiera

GIRELLO PER RACCORDO PORTAGOMMA



Articolo	Ø	€ Listino	
0180750	1.1/4"	1,10	25
0180760	1.1/2"	1,45	25

O.R. PER GIRELLO PORTAGOMMA



Articolo	Lmm	Ø	€ Listino	
0180850	26,7x2,6	1.1/4"	0,50	50
0180860	29,2x2,0	1.1/2"	0,50	50

GIRELLO PER RACCORDO IMMISSIONE



Articolo	Ø	€ Listino	
0180755	1.1/4"	1,10	25
0180765	1.1/2"	1,45	25

GIRELLO PER RACCORDO



Articolo	Ø	€ Listino	
017921	1/2"	0,46	25

RACCORDO IMMISSIONE BSP1



Articolo	Ø mm	€ Listino	
0180950	25	2,40	25

LANCIA LEVA TURBO SENZA RACCORDO ALTA PRESSIONE



Articolo	Lmm	€ Listino	
0100320	300	26,30	12
0100620	600	22,90	12
Optional			
0113080	1/2" x Ø 8	1,70	60
0113100	1/2" x Ø 10	1,70	60
0113130	1/2" x Ø 13	1,70	60

• Ugello in dotazione Ø 1,5

LANCIA A MANOPOLA TURBO SENZA RACCORDO ALTA PRESSIONE



Articolo	Lmm	€ Listino	
0110320	300	22,00	12
0110620	600	24,00	12
0111020	1000	24,60	12
Optional			
0113080	1/2" x Ø 8	1,70	60
0113100	1/2" x Ø 10	1,70	60
0113130	1/2" x Ø 13	1,70	60

• Ugello in dotazione Ø 1,5

GETTO REGOLABILE PESANTE LUNGO 3/8" M



Articolo	€ Listino	
0118105	39,32	6

• Turbo a rosa 1,5

PREMISTOPPE PER LANCIA MANOPOLA



Articolo	Lmm	€ Listino	
0202300	14x9x11	0,23	24

PREMISTOPPE PER LANCIA LEVA



Articolo	Lmm	€ Listino	
0202350	12x5x11	0,80	24

TURBO UGELLO COMPLETO CERAMICA



Articolo	Lmm		€ Listino	
0200540	40	0,050	4,76	24

• Diametro foro ugello 1,5

TURBO UGELLO COMPLETO ACCIAIO



Articolo	Lmm		€ Listino	
0200530	40	0,050	4,30	12

• Diametro foro ugello 1,5

TESTATA COMPLETA UGELLO CERAMICA



Articolo	€ Listino	
0200510	2,62	24

• Diametro foro ugello 1,5

UGELLO A ROSA CERAMICA PER 0200510



Articolo	Ø Foro	€ Listino	
0200210	1,0 mm	1,14	24
0200212	1,2 mm	1,14	24
0200215	1,5 mm	1,14	24

TESTATA COMPLETA UGELLO ACCIAIO



Articolo	€ Listino	
0200500	2,88	12

• Diametro foro ugello 1,5
Attacco F da 1/2

TESTATA PORTATESTINA LANCIA



Articolo	€ Listino	
0200400	2,00	12
0200350	Guarnizione F piccola 0,05	1
0200450	Guarnizione M grande 0,12	1

TESTATA PORTAUGELLO ACCIAIO



Articolo	€ Listino	
0200420	1,40	12

• Diametro foro ugello 1,5

UGELLO A ROSA ACCIAIO



Articolo	Ø Foro	€ Listino	
0200015	1,5 mm	0,98	24
0200018	1,8 mm	0,98	24

• Ricambio per 0200500 e 0200420

GUARNIZIONE PIATTA



Articolo	Ø	€ Listino	
0200450	22 mm	0,12	100

• Adatta per: 0200500-0200540-0200530-0200510-0200500-0200400

RACCORDO GIREVOLE 1/2"



Articolo	€ Listino	
0111401	4,50	24

GIUNTO PORTAGOMMA DRITTO CON GHIERA 1/2"



Articolo	Ø mm	€ Listino	
0113080	8	1,70	60
0113100	10	1,70	60
0113130	13	1,70	60

AGITATORE A CANNA CURVO



Articolo	Ø mm	€ Listino	
0112500	11	14,94	1

ASTE IN ACCIAIO INOX AISI 304 CON MORSETTI



Articolo	L cm	Attacchi	€ Listino	
0120830	80	3	27,48	2
0121040	100	4	34,54	2
0121250	120	5	40,34	2

PORTAGETTO OTTONE



Articolo	Ø mm	Filetto	€ Listino	
0115130	20	1/4"	3,10	25
0115135	21	1/4"	3,40	25

PREMISTOPPE OTTONE ALTA PRESSIONE FEMMINA



Articolo	€ Listino	
0500210	9,87	25

• Per avvolgitubo

GETTO A GALLETTO TURBO CERAMICA

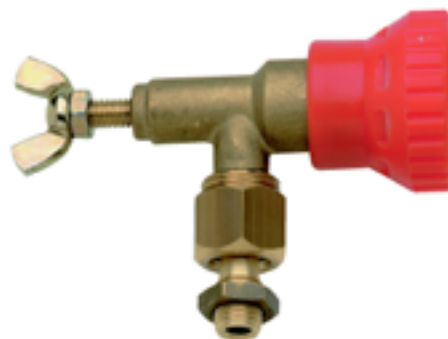

Articolo	Filetto	€ Listino	
0115110	1/4" M	13,36	12
0200540	Turbo ugello ceramica	4,30	12
0200212	Ugello ceramica Ø 1,2	1,14	12
0200450	Guarnizione	0,12	12

RICAMBI PER GETTO 1/4"



Articolo	Tipo	€ Listino	
0200570	Dado	1,00	24
0200580	Snodo sferico	1,40	24
0200590	Controdado	0,30	24

RICAMBI PER GETTO 3/8"



Articolo	Tipo	€ Listino	
0202750	Dado	1,60	24
0202730	Snodo sferico	1,60	24
0202740	Controdado	0,90	24

GETTO CHIUDIBILE 1/4" M ATOMIZZATORE ANTIGOCCIA

• Getto singolo completo di filtro, convogliatore, guarnizione e piastrina.

Piastrina diametro 18 mm - foro 1,5 mm.
Foro convogliatore 1,5 mm
Attacco filettato G 1/4 M

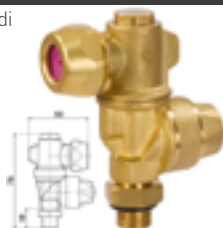

Articolo	€ Listino	
0115345	18,30	12

GETTO DOPPIO 1/4" M ATOMIZZATORE ANTIGOCCIA

• Getto doppio completo di filtro, convogliatore, guarnizione e piastrina. GETTO (A)

Piastrina diametro 18 mm
- foro 1,2 mm. - Convogliatore CIECO
GETTO (B) Piastrina diametro 18 mm
- foro 1,5 mm.
- Foro convogliatore 1,2 mm
Attacco filettato G 1/4 M



Articolo	€ Listino	
0115355	21,70	12

Per informazioni tecniche, foto e prezzi aggiornati visita il nostro sito www.cillisrl.com

GETTO DOPPIO M



Articolo	Ø	€ Listino	
0115350	1/4"	13,00	6

GUARNIZIONE



Articolo	Ø mm	Tipo	€ Listino	
0115225	26	Esterna	0,15	24
0115207	26	Piana	0,14	24

GETTO DISERBO A CAVALLOTTO



Articolo	Attacco Ø	€ Listino	
0170010	20	1,30	24
0170020	1/2"	1,84	24

• Kit bulloni bloccaggio non in dotazione

GETTO DISERBO A CAVALLOTTO CON ANTIGOCCIA



Articolo	Attacco Ø	€ Listino	
0170008	20	3,50	24
0170005	1/2"	3,64	24

• Kit bulloni bloccaggio non in dotazione

GETTO DISERBO A CAVALLOTTO 3 VIE CON ANTIGOCCIA



Articolo	Attacco Ø	€ Listino	
0170025	1/2"	11,35	12

• Kit bulloni bloccaggio non in dotazione

GIRELLO GETTO DISERBO 3/8"



Articolo	€ Listino	
0170200	0,58	12

MORSETTO BLOCCAGGIO BARRA DISERBO



Articolo	Attacco	€ Listino	
0170800	20X20	1,58	24

• Kit bulloni bloccaggio non in dotazione

MORSETTO PORTABARRA



Articolo	Attacco	€ Listino	
0170850	1/2"x20	1,58	24
0170870	1/2"x25	1,58	24
0170880	20x20	1,58	24
0170885	20x25	1,58	24

• Kit bulloni bloccaggio non in dotazione

UGELLO INIEZIONE ARIA CERAMICA 110°



Articolo	N°	€ Listino	
0170462	2 Giallo	9,30	25
0170463	3 Blu	9,30	25
0170464	4 Rosso	9,30	25

UGELLO SPETTRO VENTAGLIO AMPIO



Articolo	N°	€ Listino	
0170432	2 Giallo	4,05	25
0170433	3 Blu	4,05	25
0170434	4 Rosso	4,05	25

UGELLO A VENTAGLIO KEMATAL



Articolo	Ø Foro	Colore	€ Listino	
0170408	0,8	Giallo	0,92	25
0170410	1,0	Blu	0,92	25
0170412	1,2	Rosso	0,92	25
0170415	1,5	Marrone	0,92	25
0170418	1,8	Grigio	0,92	25

CONVOGLIATORE CIECO KEMATAL



Articolo	Ø Foro	€ Listino	
0170235	15	0,50	25

FILTRO ANTIGOCCIA



Articolo	Mesh	€ Listino	
0170705	50	1,32	24
0170710	100	1,32	24

MANOMETRO PROFESSIONALE GLICERINA INOX ISOMETRICO G 1/4"



Articolo	Ø	Bar	€ Listino	
1500000	63	0-5/25	66,22	5

MANOMETRO GLICERINA 1/4"



Articolo	Ø	Bar	€ Listino	
1500006	63	0-6	10,00	20
1500010	63	0-10	10,00	20
1500025	63	0-25	10,00	20
1500040	63	0-40	10,00	20
1500060	63	0-60	10,00	20
1500100	63	0-100	10,00	20

MANOMETRO A SECCO 1/4"



Articolo	Ø	Bar	€ Listino	
1500002	50	0-6	5,00	20
1500003	60	0-10	5,00	20
1500005	50	0-120	5,00	20

MANOMETRO A SECCO 1/4"



Articolo	Ø	Bar	€ Listino	
9729405	63	0-12	5,50	20

MANOMETRO A SECCO 1/8"



Articolo	Ø	Bar	€ Listino	
9729415	40	0-12	5,00	20

MANOMETRO A SECCO 1/8"



Articolo	Ø	Bar	€ Listino	
9729399	50	0-12	5,40	20

AVVOLGITUBO PER CARRIOLA 25 MT



Articolo	€ Listino	
0500170	25,00	10

• Compreso di raccordo. Gli attacchi possono essere stretti o allargati adattandosi così al supporto.

CILLI TEK III

AVVOLGITUBO A STAFFA ALTA PRESSIONE IRRORAZIONE

- Solida costruzione in lamiera di acciaio stampato.
- Disco verniciato e struttura zincata per una maggiore resistenza alla ruggine.
- Pressione di esercizio max 40 Atm.
- Attacco portagomma universale per tubo irrorazione Ø 8-10 mm x 1/2".

PRO

Articolo	Capienza	€ Listino	
0500350	200 mt	86,00	6
0500400	250 mt	90,00	6
0500460	300 mt	95,00	6



CILLI TEK III

KIT SMONTATO AVVOLGITUBO ALTA PRESSIONE A STAFFA IRRORAZIONE

- Solida costruzione in lamiera di acciaio stampato.
- Disco verniciato e struttura zincata per una maggiore resistenza alla ruggine.
- Pressione di esercizio max 40 Atm.
- Attacco portagomma universale per tubo irrorazione Ø 8-10 mm x 1/2".
- ARTICOLO SMONTATO

PRO

Articolo	Capienza	€ Listino	
0500330	200 mt	75,00	3
0500380	250 mt	79,00	3

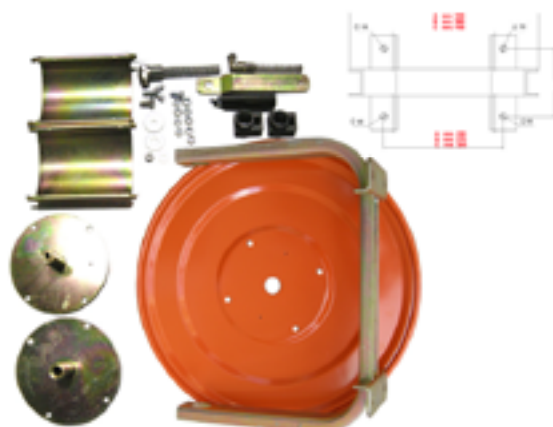

CILLI TEK III

AVVOLGITUBO DEL VERDE ALTA PRESSIONE FISSO IRRORAZIONE

- Solida costruzione in lamiera di acciaio stampato. Verniciati a polvere per una maggiore resistenza alla ruggine.
- Pressione di esercizio max 40Atm.

Attacco portagomma universale per tubo irrorazione Ø8-10mm per un massimodi 250ml.
Articolo fornito in kit da montare. Montaggio rapido.

PRO

Articolo	Capienza	€ Listino	
0500060	250 mt	108,00	2



CILLI TEK III

AVVOLGITUBO NAVAJO ALTA PRESSIONE IRRORAZIONE CARRELLATO

- Solida costruzione in lamiera di acciaio stampato. Verniciati a polvere per una maggiore resistenza alla ruggine.

Pressione di esercizio max 40Atm. Attacco portagomma universale per tubo irrorazione Ø8-10mm per un massimo di 250ml.

Ruote pneumatiche 260x85

Confezione da 2 pezzi.

Articolo fornito in kit da montare Montaggio rapido.

PRO

Articolo	Capienza	€ Listino	
0500010	250 mt	166,00	2



AVVOLGITUBO VICTORIA IRRORAZIONE ALTA PRESSIONE CARRELLATO

SENZA MOTORE DA ORDINARE A PARTE

Solida costruzione in lamiera di acciaio stampato. Verniciati a polvere per una maggiore resistenza alla ruggine.

- Dimensioni: 95 x 60 x h74 cm
- Pressione di esercizio max 40 Atm.
- Attacco portagomma universale per tubo irrorazione Ø 8-10 mm x 1/2".

Dimensioni avvolgitubo:

- Diametro dischi 41 cm
- Larghezza tra i due dischi 30 cm
- Larghezza (esterno dischi) 35 cm
- Interasse fori 32 x 8 cm



ATTENZIONE

L'avvolgitubo è ideale per 300 mt di tubo alta pressione con un diametro esterno massimo di 10 mm. Montando tubi con diametri esterni superiori, la portata di metri dell'avvolgitubo diminuirà.

Passatubo



Telaio con attacchi per motopompe AR



Maniglia regolabile



Ruote antiforo



PRO



Articolo	€ Listino	
6140005 Kit Smontato MIN. 2 PZ.	200,00	1
6130030 Motopompa AR 202 HP 2,5	612,00	1

CILLI TEK III

KIT CARRIOLA IRRORAZIONE NIAGARA

SENZA MOTORE DA ORDINARE A PARTE

Solida costruzione in lamiera di acciaio stampato. Verniciata a polvere per una maggiore resistenza alla ruggine. Dimensioni 80 Lt : 105x65x75cm. Grande capacità di carico unita ad un'ottima maneggevolezza grazie alle ruote antiforatura. Ideale per trattamenti di irrorazione di prodotti antiparassitari, diserbo chimico e per la distribuzione di concimi liquidi in soluzione. Per trattamenti di irrorazione di serre, giardini, aiuole e orti e per la disinfezione di ambienti sia aperti che chiusi. Per lavaggio di impianti fissi industriali, fognari e di spurgo e per sistemi antincendio.



Maniglia passatubo



Telaio con attacchi per motopompe AR



Maniglia regolabile



Ruote antiforo



PRO 

Articolo	€ Listino	
6130280 Carriola 80 LT	420,00	1
6130030 Motopompa AR 202	612,00	1

MOTOPOMPA DL 218

PRO

Articolo	€ Listino	
3006030	599,00	1

Gruppo motopompa elettrico adatto a spruzzare liquidi anticrittogamici sulle piante e colture in generale, diserbo, disinfestazione locali o in qualsiasi altro lavoro dove serve applicare un prodotto nebulizzato non aggressivo.

CARATTERISTICHE

Motore elettrico	Monofase 230 V/50 Hz
Potenza	kW 0,73
Portata	18 lt/min
Pressione max	20 bar
Posizioni regolazione	0 - 10 - 20 bar



MOTOPOMPA AR 202 S VRI



PRO

Articolo	HP	€ Listino	
6130030	2,5	612,00	1

CARATTERISTICHE

Tipo motore	4 tempi (OHC)
Potenza	2,5 HP - 1.0 kW - 3,600 r/min
Coppia massima	3N m / 2,500 r/min
Capacità serbatoio benzina	2 lt
Capacità serbatoio olio	0,3 lt
Minimo rapporto di consumo carburante g / kWh	minore o uguale 450 g/kWh
Raffreddamento	ad aria forzata
Peso a secco	8,8 kg



MOTOPOMPA AR 303 S GCI



PRO

Articolo	HP	€ Listino	
6130033	5,5	874,00	1

CARATTERISTICHE

Motore	Rato R210
Dimensioni	L 390 x W 320 x H 345 mm
Peso a secco	16 kg
Tipo motore	4 tempi (OHV)
Spostamento	212 ml
Alesaggio per corsa	70 x 55 mm
Rapporto di compressione	8.5:1
Potenza di uscita max	4.2 kW - 3.600 r/min
Coppia massima	12N m / 2,500 r/min
Capacità serbatoio benzina	3.6 lt
Raffreddamento	ad aria forzata





ELETTROPOMPA AR DUE VRI

PRO

Articolo	HP	€ Listino	
6130036	1,2	511,36	1

CARATTERISTICHE

Tipo motore	Elettrico asincrono monofase - max 25 bar
Potenza	1,2 Hp - 0,9 Kw
Alimentazione	220 / 240 V - 50 Hz - 4 poli
Protezione	IP 54
Giri max	1400 rpm



ELETTROPOMPA AR 202 VRI

PRO

Articolo	HP	€ Listino	
6130039	1,2	568,48	1

CARATTERISTICHE

Tipo motore	Elettrico asincrono monofase
Potenza	1,2 Hp - 0,9 Kw
Alimentazione	220 / 240 V - 50 Hz - 2 poli



ELETTROPOMPA AR DUE VRI 12V

PRO

Articolo	HP	€ Listino	
6130042	0,34	666,40	1

CARATTERISTICHE

Tipo motore	Elettrico 12 Volt - 300 W
Potenza	0,34 HP - 0,25 Kw
Nm / A	0,077
Protezione	IP 20
Giri max	1250 rpm



POMPA A DIAFRAMMA ALTA PRESSIONE

PRO

Articolo	€ Listino	
6100990	170,00	1

CARATTERISTICHE

Tipo motore	Elettrico 12 Volt - 130 W
Pressione regolabile	60 - 160 psi
Impostazioni di fabbrica	120 psi
Portata	7,5 l/min
Corrente	10 amp



• Pressostato automatico all'interno.

La pressione massima può raggiungere i 160 psi, adatta per spruzzatori di grandi dimensioni, lavaggio ad alta pressione, booster di purificazione dell'acqua, rullo a tutte le apparecchiature pressurizzate necessarie. Portata massima della pompa a diaframma a 3 cavità può raggiungere 8 lt/min. Auto aspirazione, breve tempo a secco, bassa corrente.

KIT AVVOLGITUBO CARRELLATO IRRORAZIONE ALTA PRESSIONE

- Ruote pneumatiche 260x85
- 50 mt tubo a.p. 8mm 25-75 ATM
- Lancia leva turbo ceramica 600mm
- Motore a scoppio 1HP-2T miscela 4%
- Pressione 15-25BAR portata 8l/min
- Pompa a pistoni corpo metallo
- Tubo aspirazione D.15 mt 22 con filtro
- Raccordi e fascette inclusi
- FORNITO IN KIT DA MONTARE.

Articolo	€ Listino	
6128010	498,00	1

CARATTERISTICHE

Cilindrata motore	25.6 cc
Potenza motore	0.75 kW - 2 tempi
Portata	6 l/min
Pressione	25 bar
Distanza max irrorazione	8 m
Tubo alta pressione	50 mt - 8 mm - 25 bar
Lunghezza lancia a leva	60 cm
Dimensioni	L 63 x P 103 x H 76 cm
Alimentazione	Miscela 4%
Ruote pneumatiche	260x85



KIT CARRIOLA IRRORAZIONE MOTORE A SCOPPIO 2 TEMPI



Motore a scoppio, a 2 tempi, pressione 15-25Bar. Tubo Ø interno 8,5mm, Ø esterno 14mm. Pompa con corpo metallico. Fornito di avvolgitubo + Lancia a manopola 100cm.

MISCELA 4%

Per trattamenti di irrorazione di prodotti antiparassitari, diserbo chimico e per la distribuzione di concimi liquidi in soluzione. Per trattamenti di irrorazione di serre, giardini, aiuole e orti e per la disinfezione di ambienti sia aperti che chiusi.

Per lavaggio di impianti fissi industriali, fognari e di spurgo e per sistemi antincendio.

Carriola fornita con avvolgitubo, tubo 20 metri alta pressione, lancia a manopola da 100 cm.

Articolo	€ Listino	
6130001	540,00	1

CARATTERISTICHE

Cilindrata motore	25.6 cc
Potenza motore	0.75 kW - 2 tempi
Portata	6 l/min
Pressione	15-25 bar
Distanza max irrorazione	8 m
Capacità serbatoio	50 lt
Lunghezza tubo	20 mt
Lunghezza lancia manopola	100 cm
Dimensioni	99x51x86 h
Alimentazione	Miscela 4%





KIT CARRIOLA IRRORAZIONE MOTORE A SCOPPIO 4 TEMPI

• Motore a scoppio, a 4 tempi, pressione 15-25Bar. Tubo Ø interno 8,5mm, Ø esterno 14mm. Pompa con corpo metallico. Fornito di avvolgitubo + Lancia a manopola 100cm.

BENZINA

Per trattamenti di irrorazione di prodotti antiparassitari, diserbo chimico e per la distribuzione di concimi liquidi in soluzione. Per trattamenti di irrorazione di serre, giardini, aiuole e orti e per la disinfezione di ambienti sia aperti che chiusi.

Per lavaggio di impianti fissi industriali, fognari e di spurgo e per sistemi antincendio.

Carricola fornita con avvolgitubo, tubo 20 metri alta pressione, lancia a manopola da 100 cm.

Articolo	€ Listino	
6130002	640,00	1

CARATTERISTICHE

Cilindrata motore	31 cc
Potenza motore	0.93 kW - 4 tempi
Portata	6 l/min
Pressione	25 bar
Distanza max irrorazione	8 m
Capacità serbatoio	50 lt
Lunghezza tubo	20 mt
Lunghezza lancia manopola	100 cm
Dimensioni	99x51x86 h
Alimentazione	Benzina



GRUPPO A SCOPPIO 25 LITRI 2 TEMPI

• Pompa con corpo metallico. Tubo interno diam.8,5mm tubo esterno diam.14mm.

MISCELA 4%

Gruppo pompa a scoppio con serbatoio da 25 litri per irrorazione diserbo. Tipo di motore a scoppio 2 tempi.

Articolo	Tipo	€ Listino	
6125030	senza carrello	220,00	1

CARATTERISTICHE

Tipo motore	a scoppio 2 tempi
Peso	11 Kg
Carburante	miscela 4%
Capacità serbatoio	25 litri
Livello acustico	< 104 dB
Cilindrata	23 CC
Potenza	1,3 HP
Dimensioni	42 x 33 x66 cm





GRUPPO A SCOPPIO 25 LITRI 2 TEMPI CON CARRELLO

• Pompa con corpo metallico. Tubo interno diam.8,5mm tubo esterno diam.14mm.

MISCELA 4%

Robusto telaio in acciaio con ruote piene antifuoro.

Gruppo pompa a scoppio con serbatoio da 25 litri per irrorazione diserbo. Tipo di motore a scoppio 2 tempi.

CON CARRELLO

Articolo	Tipo	€ Listino	
6125035	con carrello	280,00	1

CARATTERISTICHE

Tipo motore	a scoppio 2 tempi
Peso	11 Kg
Carburante	miscela 4%
Capacità serbatoio	25 litri
Livello acustico	< 104 dB
Cilindrata	23 CC
Potenza	1,3 HP
Dimensioni	42 x 33 x66 cm



GRUPPO IRRORAZIONE MOTORE A SCOPPIO 2 TEMPI

• Motopompa portatile per irrorazione, completa di tubo di pescaggio, lancia e 15 metri di tubo.

Applicazioni: trattamenti antiparassitari a piante, fiori, vigneti, alberi da frutto ed ortaggi; diserbo su viali ed aiuole; disinfezione di ambienti; aspersione di liquidi repellenti per insetti; piccoli lavaggi.

Articolo	€ Listino	
6130015	216,00	1

CARATTERISTICHE

Tipo motore	a scoppio 2 tempi
Peso	10,5 Kg
Carburante	miscela 4%
Portata	8 l/min
Livello acustico	< 104 dB
Cilindrata	23 CC
Potenza	1,3 HP
Lunghezza tubo	15 mt
Pressione	0-25 Bar





GRUPPO IRRORAZIONE ELETTRICO 0-20 BAR 220V 750W

Articolo	€ Listino	
6130025	240,00	1

CARATTERISTICHE

Tipo motore	Elettrico
Voltaggio	220-240V /50 Hz - 5.45A
Potenza	750W
Velocità rotazione	1400 rpm
Grado protezione	IP 44
Temperatura max	35°C
Pressione	0-25 bar
Pistoni	trasmissione ad ingranaggi in parallelo
Cilindri	2
Lunghezza tubo alta pressione	8 mt
Dimensioni gruppo pompa	34 x 28x h 17 cm
Peso	14 Kg



ATOMIZZATORE A SCOPPIO

• Atomizzatore a scoppio 14 litri completo di kit polveri.
Attenzione: l'atomizzatore può effettuare erogazioni di prodotti solo in orizzontale, non è possibile utilizzarlo verticalmente.
NON UTILIZZARE LA MACCHINA CON LA POLVERE DI ZOLFO

Articolo	€ Listino	
6125010	250,00	1

CARATTERISTICHE

Tipo motore	a scoppio 2 tempi
Gittata orizzontale	11 mt
Peso	11 Kg
Carburante	miscela 4%
Capacità serbatoio	14 litri
Livello acustico	< 108,6 dB
Cilindrata	41,7 CC
Potenza	2,13 kW / 7500 r/min



FASCETTA STRINGITUBO



PRO

Articolo	Ø	Lmm	€ Listino	
0400010	10-16	8	0,17	2000
0400011	13-19	8	0,17	2000
0400012	16-23	8	0,18	2000
0400015	13-19	13	0,26	2000
0400016	19-27	13	0,26	1000
0400023	23-36	13	0,37	1000
0400030	29-47	13	0,40	1000
0400032	32-51	13	0,42	1000
0400040	40-64	13	0,44	1000
0400070	70-90	12	0,57	1000
0400080	80-100	12	0,57	1000

SET 6 FASCETTE



Articolo	Serraggio	€ Listino	
9896036	3x8-18/2x13-23/1x14-27	0,60	100
9896038	8-18	0,60	100
9896040	13-23	0,63	100



TAGLIO E POTATURA



CILLITEK 

Specialisti del taglio

Cutting specialists



**MADE IN
KOREA**



www.cillitek.com

SEGACCI PROFESSIONALI PROFESSIONAL SAWS



- Impugnatura rivestita con gomma antiscivolo, in alluminio o plastica, a seconda del modello.
- Handle coated with non-slip rubber, aluminum or plastic, depending on the model.

- Lama costruita con acciaio temperato di altissima qualità.
- Blade made of high quality tempered steel

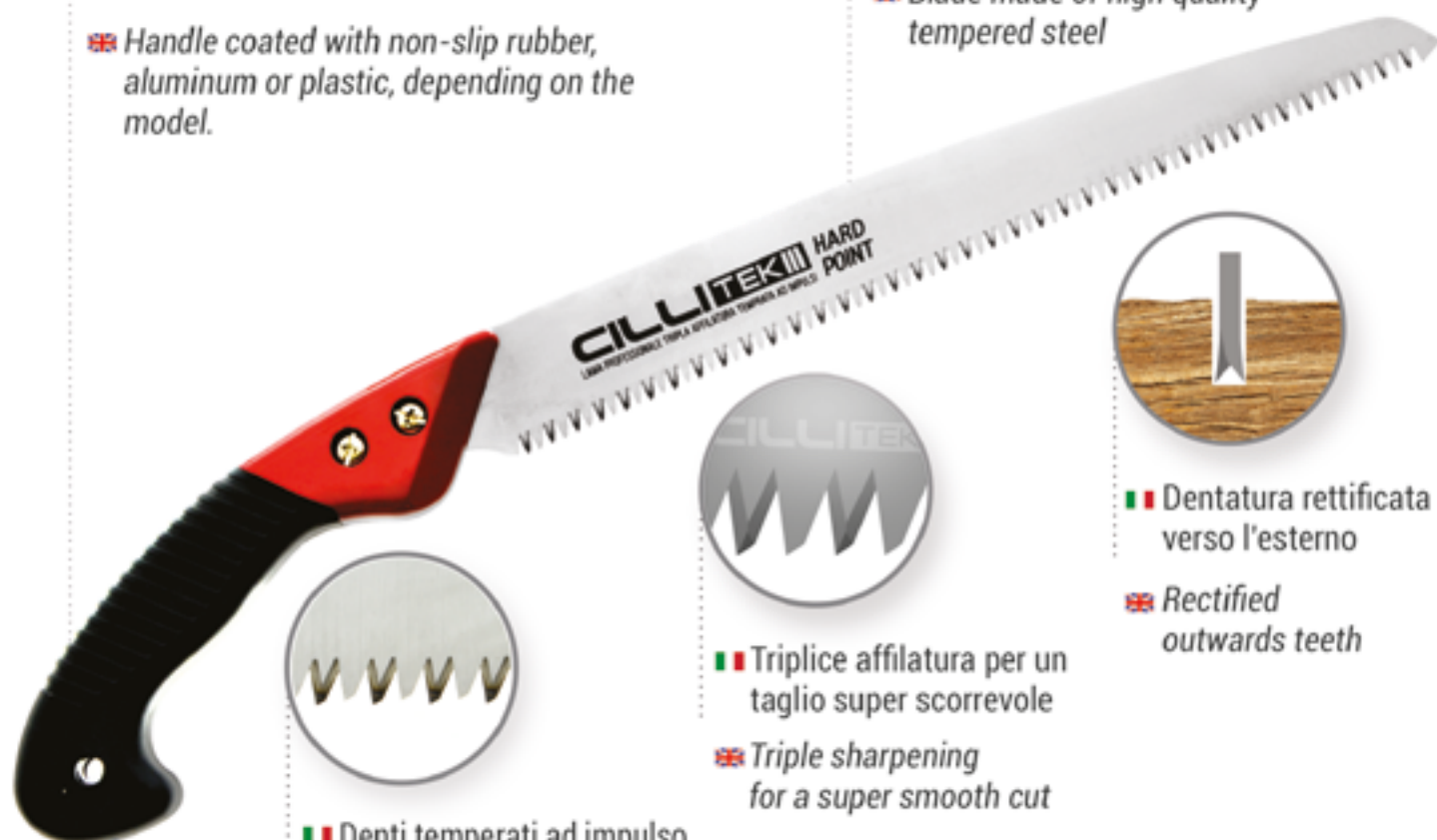

- Denti temperati ad impulso
- Impulse-hardened teeth

- Triplice affilatura per un taglio super scorrevole
- Triple sharpening for a super smooth cut

- Dentatura rettificata verso l'esterno
- Rectified outwards teeth



LAME DI RICAMBIO DISPONIBILI AVAILABLE SPARE BLADES

Caratteristiche riferite agli articoli:
Characteristics referred on items:

9678180 - 9678210 - 9677790 - 9677200 - 9677940 - 9677330 - 9677780

CILLITEK

dal 1984 innovazione in campo
since 1984 innovation in the field

CILLI TEK III

**SEGACCIO A SERRAMANICO
FISSO ALLUMINIO**

- Asta in alluminio
- Taglio 320 mm
- Lama richiudibile



PRO

Articolo	Lcm	€ Listino	
9676608	200	75,60	2
9677225	Lama ricambio	20,00	6

CILLI TEK III

**SEGACCIO A SERRAMANICO
TELESCOPICO ALLUMINIO**

- Asta in alluminio
- Taglio 320 mm
- Lama richiudibile



PRO

Articolo	Lcm	€ Listino	
9676615	200-350	98,00	2
9677225	Lama ricambio	20,00	6



SEGACCIO LASERCUT HP







Denti temperati ad impulso

Triplice affilatura per un taglio super scorrevole

Dentatura rettificata verso l'esterno

GARANZIA 4 ANNI



PRO

Articolo	Lmm	€ Listino	
9678180	180	14,00	10
9678185	Lama ricambio	10,00	12
9678205	210	15,00	10
9678207	Lama ricambio	11,00	12



SEGACCIO TOPCUT 210 HP







Denti temperati ad impulso

Triplice affilatura per un taglio super scorrevole

Dentatura rettificata verso l'esterno

GARANZIA 4 ANNI



PRO

Articolo	Lmm	€ Listino	
9678210	210	20,00	10
9678215	Lama ricambio	12,80	6



SEGACCIO TOPCUT HP MANICO ALLUMINIO CON CUSTODIA





Denti temperati ad impulso

Triplice affilatura per un taglio super scorrevole

Dentatura rettificata verso l'esterno

GARANZIA 4 ANNI



PRO

Articolo	Lmm	€ Listino	
9677790	240	24,00	10
9677220	Lama ricambio	12,00	12



SEGACCIO TOPCUT HP MANICO ALLUMINIO CON CUSTODIA





Denti temperati ad impulso

Triplice affilatura per un taglio super scorrevole

Dentatura rettificata verso l'esterno

GARANZIA 4 ANNI



PRO

Articolo	Lmm	€ Listino	
9677200	300	26,00	10
9677810	Lama ricambio	11,60	12



SEGACCIO LASER CUT HP MANICO PLASTICA CON CUSTODIA





Denti temperati ad impulso

Triplice affilatura per un taglio super scorrevole

Dentatura rettificata verso l'esterno

GARANZIA 4 ANNI



PRO

Articolo	Lmm	€ Listino	
9677795	240	19,00	10
9677220	Lama ricambio	12,00	12



**SEGACCIO LASERCUT HP
MANICO PLASTICA CON CUSTODIA**

CLLITEK III



Denti temperati ad impulso



Tripla affilatura per un taglio super scorrevole



Dentatura rettificata verso l'esterno

GARANZIA 4 ANNI



PRO

Articolo	Lmm	€ Listino	
9677208	300	21,00	10
9677810	Lama ricambio	11,60	12



**SEGACCIO BURG HP
MANICO PLASTICA**

BURG



Denti temperati ad impulso



Tripla affilatura per un taglio super scorrevole



Dentatura rettificata verso l'esterno

GARANZIA 4 ANNI



PRO

Articolo	Lmm	€ Listino	
9677202	350	20,86	10
9677201	Lama ricambio	15,40	12



**SEGACCIO TURBO HP
MANICO LEGNO**

BURG



Denti temperati ad impulso



Tripla affilatura per un taglio super scorrevole



Dentatura rettificata verso l'esterno

GARANZIA 4 ANNI



PRO

Articolo	Lmm	€ Listino	
9677995	380	15,60	10
9677996	Lama ricambio	15,00	12



**SEGACCIO LASERCUT LAMA CURVA
MANICO ALLUMINIO CON CUSTODIA**

CLLITEK III



Denti temperati ad impulso



Tripla affilatura per un taglio super scorrevole



Dentatura rettificata verso l'esterno

GARANZIA 4 ANNI



PRO

Articolo	Lmm	€ Listino	
9677940	330	27,00	10
9677205	Lama ricambio	15,00	12



UBURG
www.uburgtools.com
PROFESSIONAL

**SEGACCIO BURG CURVO TURBO
MANICO PLASTICA CON CUSTODIA**



Denti temperati
ad impulso



Triplice affilatura per un
taglio super scorievole



Dentatura rettificata
verso l'esterno

GARANZIA
4 ANNI



PRO



Articolo	Lmm	€ Listino	
9677204	330	24,00	10

UBURG
www.uburgtools.com
PROFESSIONAL

**SEGACCIO BURGCUT LAMA DRITTA
MANICO PLASTICA OMBRELLO**



Denti temperati
ad impulso



Triplice affilatura per un
taglio super scorievole



Dentatura rettificata
verso l'esterno

GARANZIA
4 ANNI



PRO



Articolo	L mm	€ Listino	
9677360	240	17,00	12
9677220	Lama ricambio	12,00	12

CILLITEK III

**SEGACCIO LASERCUT LAMA DRITTA
MANICO OMBRELLO**



Denti temperati
ad impulso



Triplice affilatura per un
taglio super scorievole



Dentatura rettificata
verso l'esterno

GARANZIA
4 ANNI



PRO



Articolo	L mm	€ Listino	
9677330	300	17,20	12
9677810	Lama ricambio	11,60	12

UBURG
www.uburgtools.com
PROFESSIONAL

**SEGACCIO BURGCUT LAMA DRITTA
MANICO PLASTICA OMBRELLO**



Denti temperati
ad impulso



Triplice affilatura per un
taglio super scorievole



Dentatura rettificata
verso l'esterno

GARANZIA
4 ANNI



PRO



Articolo	L mm	€ Listino	
9677350	380	21,00	12
9677996	Lama ricambio	15,00	12

CILLITEK III

**SEGACCIO TOPCUT
MANICO OMBRELLO**



Denti temperati
ad impulso



Triplice affilatura per un
taglio super scorievole



Dentatura rettificata
verso l'esterno

GARANZIA
4 ANNI



PRO



Articolo	L mm	€ Listino	
9677780	300	19,80	10

MANICO RICAMBIO



GARANZIA 4 ANNI PRO

Articolo		€ Listino	
9677440	Alluminio	9,00	12
9677451	Plastica	5,00	12

BULLONE E DADO PER SEGACCIO



Articolo		€ Listino	
9677230		1,60	1

• Per segacci 9677790 - 9677200 - 9677795 - 9677208 - 9677202 - 9677940 - 9677204 - 9677440 - 9677451

MANICO RICAMBIO PLASTICA AD OMBRELLO



GARANZIA 4 ANNI PRO

Articolo	Interasse	€ Listino	
9677325	2,6 cm	4,60	24

LAMA RICAMBIO LASERCUT A LEVA



GARANZIA 4 ANNI PRO

Articolo	Lmm	Ø	€ Listino	
9678185	180	6 mm	10,00	12

• Per segacci 9679180

LAMA SEGACCIO TOPCUT 240 TURBO



GARANZIA 4 ANNI PRO

Articolo	Lmm	Ø	€ Listino	
9677220	240	6 mm	12,00	10

• Interasse: 2 - 2,6 cm
Per segacci: 9677220-9677360

LAMA SEGACCIO LASERCUT

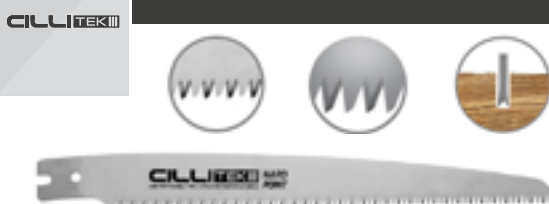

GARANZIA 4 ANNI PRO

Articolo	Lmm	Ø Fori	€ Listino	
9677810	300	6 mm	11,60	12
9677820	350	6 mm	13,00	12

• Interasse: 2 - 2,6 cm

LAMA SEGACCIO BURG HP

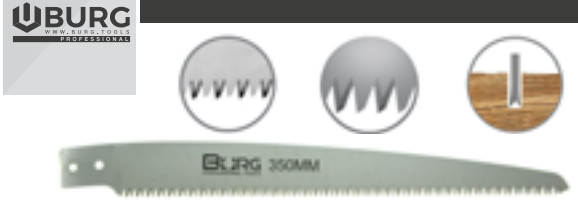

GARANZIA 4 ANNI PRO

Articolo	Lmm	Ø Fori	€ Listino	
9677201	350	6 mm	15,40	10

• Interasse: 2 cm

Per informazioni tecniche, foto e prezzi aggiornati visita il nostro sito www.cillisrl.com



LAMA SEGACCIO LASERCUT

Articolo	Lmm	Ø Fori	€ Listino	
9677205	330	6 mm	15,00	10

• Interasse: 2 - 2,4 cm



LAMA SEGACCIO BURG HP

Articolo	Lmm	€ Listino	
9677996	380	15,00	12

• Interasse: 2 cm

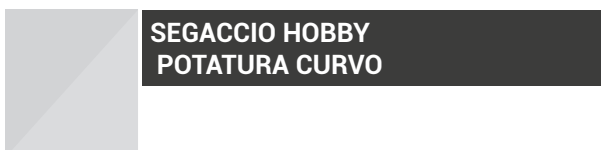

SEGACCIO HOBBY POTATURA CURVO

Articolo	Lmm	€ Listino	
9676800	300	4,40	12

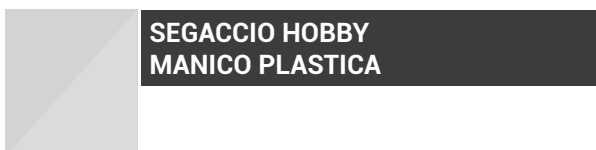

SEGACCIO HOBBY MANICO PLASTICA

Articolo	Lmm	€ Listino	
9677313	350	11,00	30
9677320	Lama ricambio	5,00	12

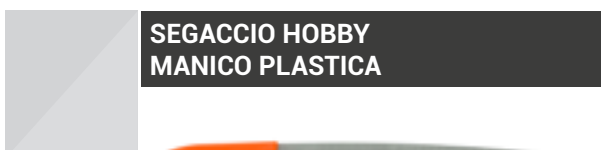

SEGACCIO HOBBY MANICO PLASTICA

Articolo	Lmm	€ Listino	
9677300	300	8,00	24
9677310	350	8,00	24
9677320	Lama ricambio	5,00	12
9677325	Manico ricambio	4,60	24



SEGACCIO MANICO OMBRELLO

Articolo	Lmm	€ Listino	
9677950	350	15,00	12



LAMA SEGACCIO

Articolo	Lmm	Ø Fori	€ Listino	
9677320	350	5 mm	5,00	12

• Interasse: 1,5 - 2,5 cm

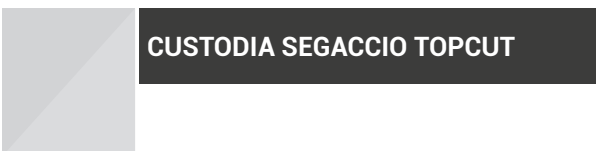

CUSTODIA SEGACCIO TOPCUT

Articolo	Lmm	€ Listino	
9677480	300	2,20	12



SEGACCIO POTATURA CURVO CON ATTACCO ASTA



Articolo	Lmm	€ Listino	
9676700	400	10,00	12
9686155	Manico rastrello 150 cm	2,55	100
9686180	Manico rastrello 175 cm	3,16	100

• Ideale per la manutenzione di boschi e di alberi di frutta.
Diametro interno attacco asta 25 mm

ARCHETTO CON LAMA GIREVOLE



Articolo	Lmm	€ Listino	
9675530	530	6,00	24

• Ideale per la manutenzione di boschi e di alberi di frutta.

ARCHETTO CON LAMA GIREVOLE BAHCO



PRO

Articolo	Lmm	€ Listino	
9675540	530	8,20	30

• Archetto universale per legno con lama girevole.
Fornito con lama 51 adatta al taglio di legno secco.
Lunghezza 530 mm / 21 in
Peso 620 gr

**LAMA SANDVIK HP 533-21
LAMA LEGNO SECCO 21/B**



PRO

Articolo	Lmm	€ Listino	
9676010	533	10,90	20

• Lama 51 adatta al taglio di legno secco. Denti stradati, triangolari; punte rivolte verso il basso. Le punte dei denti sono temprate a induzione ad alta frequenza con taglienti affilati su entrambi i lati. Temprato. Ogni tre denti la gola è più estesa per una migliore asportazione del truciolo. Taglia sia tirando che in spinta.

**LAMA SANDVIK HP 533-21
LAMA A CASTELLO 21**



PRO

Articolo	Lmm	€ Listino	
9676070	533	10,90	20

• Lama 23 dentatura a castello per legno verde vivo. Denti stradati, triangolari; punte rivolte verso il basso. Le punte dei denti sono temprate a induzione ad alta frequenza con taglienti affilati su entrambi i lati. Temprato. Ogni tre denti la gola è più estesa per una migliore asportazione del truciolo. Taglia sia tirando che in spinta.

SEGONCINO BILAMA CON LAME DI RICAMBIO



Articolo	Lmm	€ Listino	
9676500	300	7,00	24

ARCHETTO OVALE CON LAMA



Articolo	Lmm	€ Listino	
9675535	530	6,00	12

• Ideale per la manutenzione di boschi e di alberi di frutta.

**LAMA TALENT TRIANGOLARE HP
CARPENTIERE**

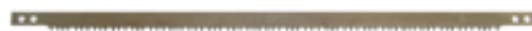

PRO

Articolo	Lmm	€ Listino	
9676222	533	2,32	100

• Denti temprati hard point

LAMA TALENT CASTELLO HP



PRO

Articolo	Lmm	€ Listino	
9676225	533	2,32	100
9676250	610	2,62	100

• Denti temprati hard point

LAMA DENTATURA A CASTELLO



PRO

Articolo	Lmm	€ Listino	
9676212	382	1,08	100
9676270	762	1,74	100

Progettazione in campo



FORBICI PROFESSIONALI E LEGGERE PROFESSIONAL LIGHTWEIGHT SCISSORS AND SHEARS

CILLITEK 



**MADE IN
ITALY**



**LEGERISSIMA
LIGHTWEIGHT**



**STAINLESS
STEEL BLADES**



**MANICI IN ALLUMINIO
ALUMINUM HANDLES**



**EASY
BLOCK
SYSTEM**
**SISTEMA DI CHIUSURA
CLOSURE SYSTEM**



**21CM
LUNGHEZZA
LENGHT**



**26MM
Ø TAGLIO
Ø CUT**

SCOPRI TUTTE LE FORBICI PROFESSIONALI CILLITEK
DISCOVER ALL THE CILLITEK PROFESSIONAL SCISSORS AND SHEARS



www.cillitek.com

CILLI|TEK **FORBICE 2 TAGLI LASERCUT**



PRO

Articolo	Lmm	Kg	Ø	€ Listino	
9700600	200	0,350	30	26,18	12

• Tipo normale



CILLI|TEK **FORBICE 2 TAGLI PROCUT**



PRO

Articolo	Lmm	Kg	Ø	€ Listino	
9700620	210	0,310	30	35,54	12

• Tipo normale



CILLI|TEK **FORBICE 2 TAGLI LASERCUT**

PRO

Articolo	Lmm	Kg	Ø	€ Listino	
9700610	200	0,350	25	26,70	12

• Tipo eccentrico



CILLI|TEK **FORBICE 2 TAGLI PROCUT**



PRO

Articolo	Lmm	Kg	Ø	€ Listino	
9700630	205	0,290	30	38,94	12

• Tipo ergonomico

CILLI|TEK **FORBICIONE 2 TAGLI TOPCUT**



PRO

Articolo	Lmm	Kg	Ø	€ Listino	
9700680	480	0,740	30	61,80	6

CILLI|TEK **FORBICE DOPPIO TAGLIO LAME IN ACCIAIO MANICI IN ALLUMINIO**



PRO

Articolo	Lmm	Kg	Ø	€ Listino	
9700655	210	0,232	28	45,00	6

Forbici con manici in alluminio ergonomici, sistema di chiusura easy block system, vite battente fermacorsa regolabile, piastrina posteriore per arresto di ramoscelli. Ideali per qualsiasi tipo di frutticoltura e arboricoltura.



FORBICE TAGLIO A BATTUTA LAME DRITE ACCIAIO MANICI ALLUMINIO



Articolo	Lmm	Kg	Ø	€ Listino	
9700690	210	0,232	26	41,20	6

Sistema di chiusura easy block system.



FORBICE TAGLIO A BATTUTA LAME CURVE ACCIAIO MANICI ALLUMINIO



Articolo	Lmm	Kg	Ø	€ Listino	
9700695	210	0,235	26	42,42	6

Sistema di chiusura easy block system.



FORBICE BY PASS LAME IN ACCIAIO MANICI ERGONOMICI IN ALLUMINIO



Articolo	Lmm	Kg	Ø	€ Listino	
9700685	210	0,230	26	38,00	6

Sistema di chiusura easy block system; gommini ammortizzatori paracolpi per un miglior assorbimento del taglio.



TAGLIARAMI A CUNEO LEVA



Articolo	Lmm	Kg	Ø	€ Listino	
9700710	600	0,950	42	87,57	2
9700715	800	1,020	45	91,68	2

Tagliarami a cuneo con lama diritta in acciaio; battente in lega di alluminio temprato; sistema di leve che diminuisce lo sforzo del taglio ed eliminare il contraccolpo finale.



Per informazioni tecniche, foto e prezzi aggiornati visita il nostro sito www.cillisrl.com

CILLITEK III TAGLIARAMI A CUNEO



  **PRO**

Articolo	Lmm	Kg	Ø	€ Listino	
9700700	600	0,920	37	53,40	3
9700705	800	1,000	40	58,92	3

Tagliarami a cuneo con lama dritta in acciaio; battente in lega di alluminio temprato.

RICAMBI FORBICI E TAGLIARAMI CILLITEK

CILLITEK III LAMA FORGIATA DRITTA



  **PRO**

Articolo	€ Listino	
9700696	21,88	1

Ricambio per 9700710, 9700715

CILLITEK III LAMA FORGIATA DRITTA CON MANICO ALLUMINIO



  **PRO**

Articolo	€ Listino	
9700716	24,62	1

Ricambio per 9700705

CILLITEK III LAMA BY PASS CON VITI



  **PRO**

Articolo	€ Listino	
9700745	17,22	1

Ricambio per 9700685

CILLITEK III LAMA BATTENTE DRITTA CON VITI



  **PRO**

Articolo	€ Listino	
9700747	16,98	1

Ricambio per 9700690

CILLITEK III LAMA BATTENTE CURVA CON VITI



  **PRO**

Articolo	€ Listino	
9700749	17,84	1

• Ricambio per 9700695

CILLITEK III GRUPPO LAMA COMPLETO



  **PRO**

Articolo	€ Listino	
9700746	30,50	1

• Ricambio per 9700655



CUNEI ALLUMINIO DRITTO

CILLI|TEK|III



PRO

Articolo	€ Listino	
9700698	12,92	1

• Ricambio per 9700710, 9700715, 9700700, 9700705



CONTROLAMA DRITTA IN ALLUMINIO

CILLI|TEK|III



PRO

Articolo	€ Listino	
9700748	5,14	1

• Ricambio per 9700690

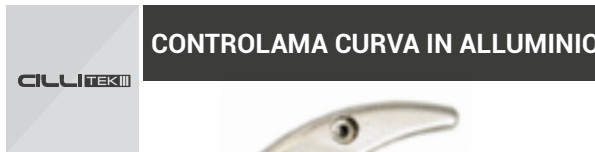

CONTROLAMA CURVA IN ALLUMINIO

CILLI|TEK|III



PRO

Articolo	€ Listino	
9700714	5,36	1

• Ricambio per 9700695

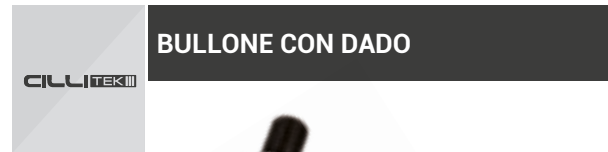

BULLONE CON DADO

CILLI|TEK|III



PRO

Articolo	€ Listino	
9700717	5,04	1

• Ricambio per 9700685, 9700690, 9700695

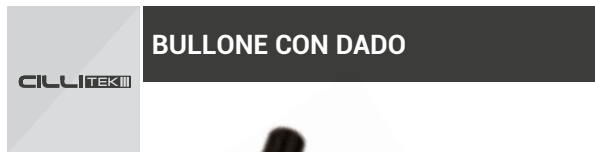

BULLONE CON DADO

CILLI|TEK|III



PRO

Articolo	€ Listino	
9700718	6,52	1

• Ricambio per 9700710, 9700715, 9700700, 9700705

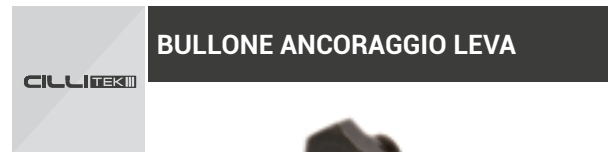

BULLONE ANCORAGGIO LEVA

CILLI|TEK|III



PRO

Articolo	€ Listino	
9700743	4,38	1

• Ricambio per 9700710, 9700715

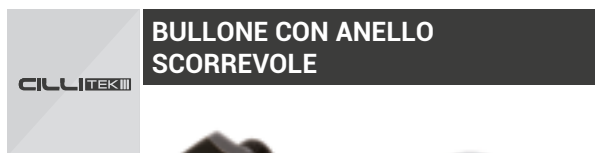

BULLONE CON ANELLO SCORREVOLE

CILLI|TEK|III



PRO

Articolo	€ Listino	
9700744	5,84	1

• Ricambio per 9700710, 9700715

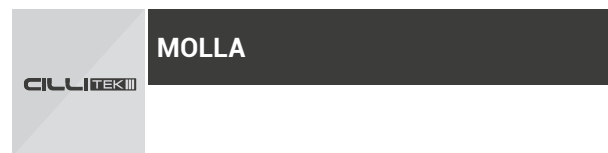

MOLLA

CILLI|TEK|III



PRO

Articolo	€ Listino	
9700719	1,00	1

• Ricambio per 9700685, 9700690, 9700695, 9700655

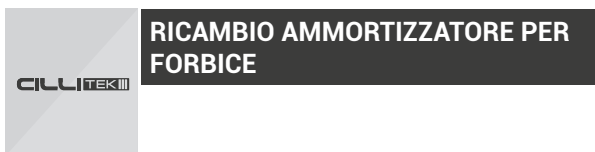

RICAMBIO AMMORTIZZATORE PER FORBICE

CILLI|TEK|III

PRO

Articolo	€ Listino	
9700740	1,10	1

• Ricambio per 9700685



BURG
www.burg.tools

FORBICE DA POTATURA INOX



INOX

Articolo	Lmm	€ Listino	
9700604	170	7,30	12

BURG
www.burg.tools

FORBICI POTATURA IN ALLUMINIO A BATTUTA



Articolo	Lmm	€ Listino	
9170018	210	22,00	10

BURG
www.burg.tools

FORBICE DA POTATURA INOX



INOX

Articolo	Lmm	€ Listino	
9700605	200	8,00	12

BURG
www.burg.tools

FORBICE UNIVERSALE INOX



INOX

Articolo	Lmm	€ Listino	
9700602	200	7,00	15

BURG
www.burg.tools

FORBICI POTATURA IN ALLUMINIO A BATTUTA



Articolo	Lmm	€ Listino	
9170020	210	23,00	10

BURG
www.burg.tools

FORBICI POTATURA



Articolo	Lmm	€ Listino	
9170022	180	8,00	

BURG
www.burg.tools

FORBICI POTATURA IN ACCIAIO INOX



INOX

Articolo	Lmm	€ Listino	
9170024	180	10,00	10

BURG
**FORBICI POTATURA
 LAMA FLOTTANTE**



Articolo	Lmm	€ Listino	
9170026	225	14,00	10
9170026A	Coppia gommini	0,80	1
9170026B	Molla ricambio	0,50	1

RICAMBI:



9170026A



9170026B

BURG
FORBICI POTATURA 21 CM



Articolo	Lmm	€ Listino	
9170028	210	14,50	10

BURG
FORBICE COGLIFRUTTA



Articolo	Lmm	€ Listino	
9170027	180	7,00	20

BURG
FORBICI COGLIUVA



Articolo	Lmm	€ Listino	
9170029	190	7,00	20

Per informazioni tecniche, foto e prezzi aggiornati visita il nostro sito www.cillisrl.com



**KIT 30 COGLIUVA P128-19
CON CUSTODIA**



Articolo	Lmm	Kg	Ø	€ Listino	
9660020	190	0,085	6	315,00	1



**KIT 30 CESCOIE P129-19
LAMA INCLINATA**



Articolo	Lmm	Kg	Ø	€ Listino	
9660060	190	0,085	6	315,00	1



**KIT 30 CESCOIE P123-19
CON CUSTODIA**



Articolo	Lmm	Kg	Ø	€ Listino	
9660055	190	0,087	10	315,00	1



**KIT 56 CESCOIE P123-19
SENZA CUSTODIA**



Articolo	Lmm	Kg	Ø	€ Listino	
9660056	190	0,087	10	574,32	1



CESCOIA PRADINES P3-23-F



Articolo	Lmm	Kg	Ø	€ Listino	
9661140	230	0,440	25	62,80	6



CESCOIA PRADINES P126-19



Articolo	Lmm	Kg	Ø	€ Listino	
9660015	190	0,245	15	21,10	12



Articolo	Lmm	Kg	Ø	€ Listino	
9660016	190	0,245	15	497,28	1



Articolo	Lmm	Kg	Ø	€ Listino	
9661223	230	0,390	25	49,60	12

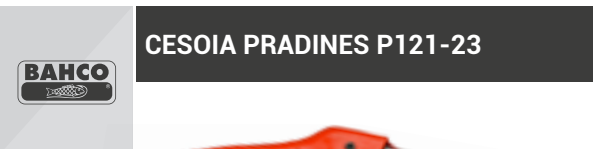

Articolo	Lmm	Kg	Ø	€ Listino	
9661450	230	0,330	25	34,10	12
9661300	Molla ricambio			1,42	12

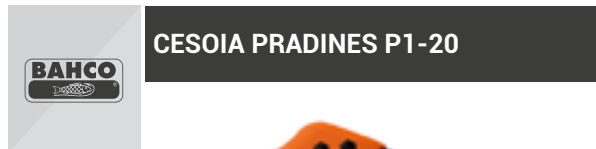

Articolo	Lmm	Kg	Ø	€ Listino	
9661010	200	0,225	20	40,80	5



Cesoie per potatura vite, frutteti e piante ornamentali. Lame con taglio passante e molatura di precisione per elevate prestazioni. Impugnature in materiale composito e per una presa confortevole. Meccanismo di chiusura azionabile con una sola mano. Ricambi disponibili

Articolo	Lmm	Kg	Ø	€ Listino	
9661015	230	0,225	30	46,40	5



Per informazioni tecniche, foto e prezzi aggiornati visita il nostro sito www.cillisrl.com

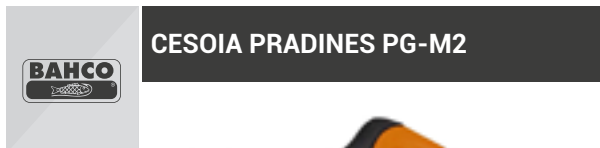

Articolo	Lmm	Kg	Ø	€ Listino	
9660063	200	0,182	20	40,60	6

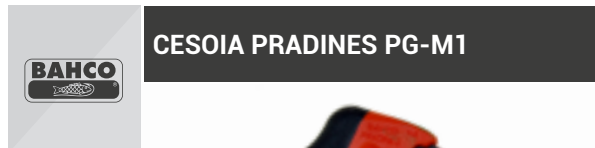

Articolo	Lmm	Kg	Ø	€ Listino	
9660064	180	0,169	15	23,80	12

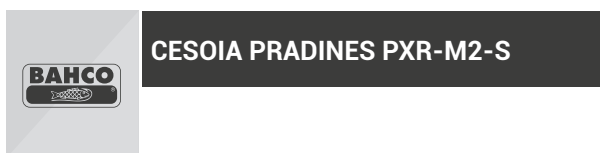

Articolo	Kg	Ø	€ Listino	
9660120	0,310	20	95,10	6

• Manico inferiore rotante

Cesoie ergonomiche progettate per adattarsi perfettamente alla mano. La forma e la dimensione dei manici si adattano alle forme delle mani. Taglio max 20mm. Le inclinazioni verticali e laterali contribuiscono al miglioramento della posizione mano/avambraccio, riducendo la fatica ed il dolore, ed aumentando il confort durante l'uso. Il modello PXR ha le medesime caratteristiche del modello px, ma con il manico inferiore rotante.

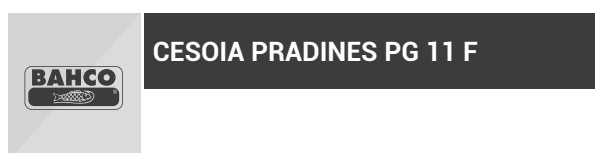

Articolo	Lmm	Kg	Ø	€ Listino	
9660010	200	0,190	20	14,90	12

Ideali per il taglio di rami verdi.
Maniglie ergonomiche

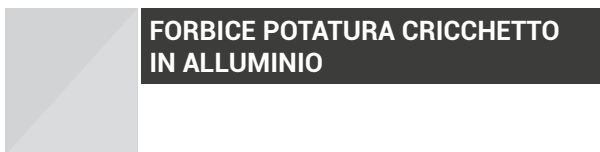

Articolo	Lmm	Kg	€ Listino	
9174200	200	0,260	8,20	24

• Impugnatura ergonomica; lama in acciaio, rivestita in teflon.
Fermo di sicurezza

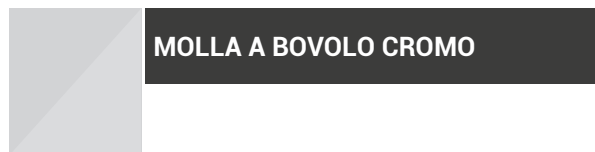

Articolo	Lmm	€ Listino	
9179010	55	0,36	100
9179020	80x82 Foro L	0,68	100
9179030	80x82 Foro S	0,30	100
9179040	70x72	0,46	50
9179050	65	0,40	100

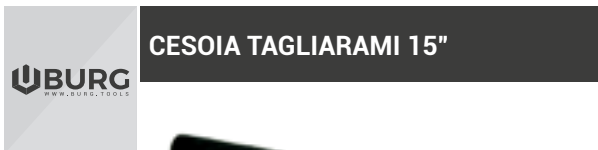

Articolo	Lmm	Kg	€ Listino	
9172610	370	0,560	6,00	12

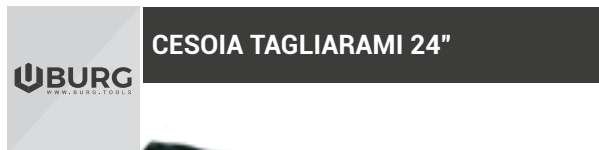

Articolo	Lmm	Kg	€ Listino	
9172608	600	0,850	9,80	24

Cesoia tagliarami 60 cm forbice per taglio rami pota potatura giardino e orto.



PRO

Articolo	Lmm	Kg	€ Listino	
9172705	640	1,200	33,00	12

Cesoia professionale Burg PRO. Manico in alluminio

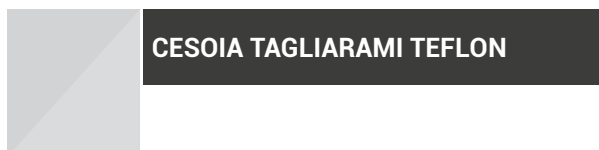

Articolo	Lmm	Kg	€ Listino	
9172611	700	1,150	16,00	24

Cesoia tagliarami 70 cm con lame teflonate.

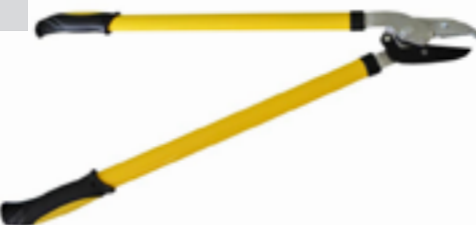
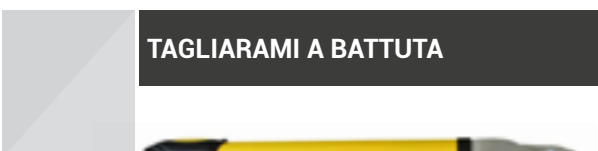

Articolo	Lmm	Kg	€ Listino	
9172500	720	1,200	10,90	24

Forbicione tagliarami 72 cm doppio taglio.

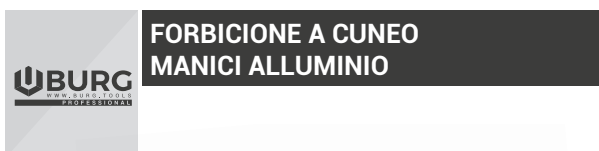

PRO

Articolo	Lmm	Kg	€ Listino	
9172710	730	1,300	35,00	12

Forbicione professionale a cuneo 73 cm con manico in alluminio.



Articolo	Lmm	Kg	Ø	€ Listino	
9661645	450	0,650	25	35,00	6

Troncarami a taglio pesante. Disegno compatto per portare anche in zone difficili da raggiungere. La testa di taglio con lame più piccole per la potatura ornamentale.

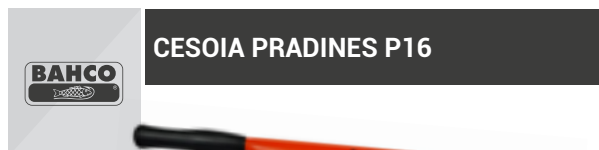

Articolo	Lmm	Kg	Ø	€ Listino	
9661660	600	1,025	30	72,00	3
9662005	Lama			38,60	3
9662025	Controlama			38,00	2
9662075	2 Ammortizzatori			7,50	1

Troncarami a taglio pesante, lama con curvatura pronunciata per tagli veloci e potenti. Confortevole nell'uso grazie ai morbidi ammortizzatori di gomma. Controlama forgiata molto robusta.

Per informazioni tecniche, foto e prezzi aggiornati visita il nostro sito www.cillisrl.com



CESOIA PRADINES P140-60

Troncarami a taglio passante per potatura di alberi e arbusti nel giardino domestico. Lama curva con movimento a scorrere per taglio più facile; ammortizzatori in materiale plastico integrati.



Articolo	Lmm	Kg	Ø	€ Listino	
9661760	600	1,000	35	48,00	6



KIT 12 CESOIA PRADINES P140-60

Troncarami a taglio passante per potatura di alberi e arbusti nel giardino domestico. Lama curva con movimento a scorrere, per taglio più facile; ammortizzatori in materiale plastico integrati



Articolo	Lmm	Kg	Ø	€ Listino	
9661755	600	1,000	35	540,00	1



CESOIA P140-70

Troncarami a taglio passante per potatura di alberi e arbusti nel giardino domestico. Lama curva con movimento a scorrere per taglio più facile; ammortizzatori in materiale plastico integrati.



Articolo	Lmm	Kg	Ø	€ Listino	
9661765	700	1,240	35	60,68	3



CESOIA P114-SL-60 ALLUMINIO

Troncarami leggero per potare il legno tenero e verde. Testa di taglio stretta per lavorare agevolmente anche in spazi ristretti, con un taglio preciso e veloce. Lama rettificata per le massime prestazioni.



Articolo	Lmm	Kg	Ø	€ Listino	
9661558	600	0,826	30	86,94	3



CESOIA P160-SL-60 ALLUMINIO

Troncarami leggero per potare il legno tenero e verde. Testa di taglio stretta per lavorare agevolmente anche in spazi ristretti, con un taglio preciso e veloce. Lama rettificata e di facile manutenzione.



Articolo	Lmm	Kg	Ø	€ Listino	
9661565	600	0,960	45	100,85	3



CESOIA P160-SL ALLUMINIO

Manici in alluminio leggeri, lunghi e resistenti. Efficace taglio dolce grazie alla lama stretta combinata con la controlama sottile. Il sistema di blocco con bullone centrale impedisce l'allentamento della lama.



Articolo	Lmm	Kg	Ø	€ Listino	
9661570	750	1,090	45	107,64	3
9661580	900	1,160	45	114,21	3

CESOIA TAGLIARAMI FORGIATA



Articolo	Lmm	Kg	€ Listino	
9172590	400	0,440	16,00	12

CESOIA TAGLIARAMI LAME TEFLON



Articolo	Lmm	Kg	€ Listino	
9172600	700	1,000	22,00	12



Articolo	Lmm	Kg	Ø	€ Listino	
9661590	800	1,320	40	89,00	2



Articolo	Lmm	€ Listino	
9660335	600-900 mm	61,60	2

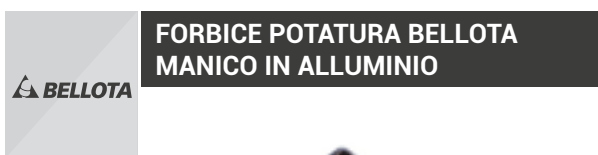

Articolo	Lmm	€ Listino	
9660330	210 mm	29,24	3

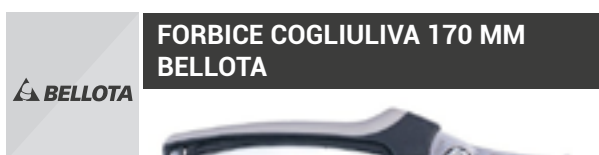

Articolo	Lmm	€ Listino	
9660320	170 mm	8,72	24

In omaggio un espositore in cartone ogni 24 pezzi acquistati.

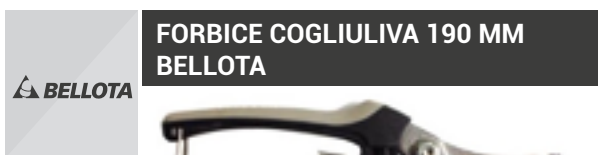

Articolo	Lmm	€ Listino	
9660315	190 mm	8,72	24

In omaggio un espositore in cartone ogni 24 pezzi acquistati.



Articolo	Lmm	€ Listino	
9660300	160 mm	8,72	24

In omaggio un espositore in cartone ogni 24 pezzi acquistati.



Articolo	Lmm	€ Listino	
9660305	210 mm	8,72	24

In omaggio un espositore in cartone ogni 24 pezzi acquistati.



Articolo	Lmm	€ Listino	
9660310	186 mm	8,72	24

In omaggio un espositore in cartone ogni 24 pezzi acquistati.

Per informazioni tecniche, foto e prezzi aggiornati visita il nostro sito www.cillisrl.com



FORBICE RACCOLTA BELLOTA PUNTA CURVA



In omaggio un espositore in cartone
ogni 24 pezzi acquistati.

Articolo	Lmm	€ Listino	
9660325	185 mm	8,72	24



SET 12 MOLLE PER FORBICI BELLOTA



Articolo	€ Listino	
9660340	7,98	1

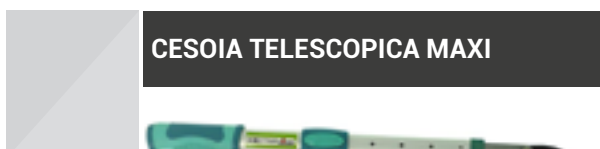

CESOIA TELESCOPICA MAXI

Articolo	Lmm		€ Listino	
9172550	475-668	0,900	25,00	10



CESOIA TAGLIARAMI TELESCOPICA MAXI

Articolo	Lmm		€ Listino	
9172580	465-645	0,910	22,00	10

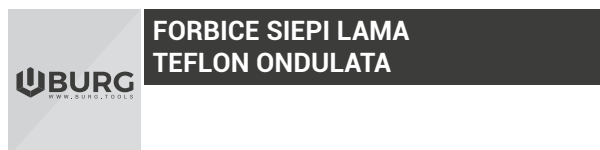

FORBICE SIEPI LAMA TEFLON ONDULATA

Articolo	Lmm		€ Listino	
9171090	600	0,960	13,00	12



TAGLIASIEPI LAMA ONDULATA



Articolo	Lmm	kg	€ Listino	
9171080	500	0,700	8,00	20

TAGLIASIEPI P51 GL



Articolo	Lmm	kg	Ø	€ Listino	
9661800	570	1,100	10	59,80	4

• Tagliasiepi, per un utilizzo professionale, lame interamente temprate. Taglia rami fino a 10 mm di spessore. Manici in alluminio leggero con rivestimento per una presa confortevole.

TAGLIASIEPI P53-SL-25-S



Articolo	Lmm	kg	Ø	€ Listino	
9661830	650	0,900	5	60,00	6

FORBICE PER SIEPI TELESCOPICA



Articolo	Lmm	kg	€ Listino	
9171050	625-815	1,200	25,00	8

FORBICE AD ASTA LUNGA CON BLOCCAFRUTTO



Articolo	Lcm	€ Listino	
9170790	640	20,00	12

• Dotato di manico girevole
• Ideale per asparagi

FORBICE AD ASTA LUNGA



Articolo	Lcm	€ Listino	
9170800	70	20,00	12

PRO

Per informazioni tecniche, foto e prezzi aggiornati visita il nostro sito www.cillisrl.com

FORBICE AD ASTA LUNGA



Articolo	Lcm	€ Listino	
9170855	120	16,00	10

FORBICE AD ASTA LUNGA



Articolo	Lcm	€ Listino	
9170900	200	33,50	12

• Dotato di manico girevole.

PRO

FORBICE AD ASTA LUNGA TELESCOPICA



Articolo	Lcm	€ Listino	
9170710	130-200	44,80	6

• Dotato di manico girevole.

PRO

FORBICE AD ASTA LUNGA TELESCOPICA



Articolo	Lcm	€ Listino	
9170700	180-270	50,00	12

• Dotato di manico girevole.
Diametro taglio 10mm massimo

PRO

SVETTATOIO PROFESSIONALE CON MANICO



Articolo	Lcm	€ Listino	
9170950	120-200	32,00	12

PRO

SVETTATOIO P34-27A



Articolo	€ Listino	
9661500	56,40	12

• Svettatoio leggero con lama interamente temperata. Controlama stampata, interamente temperata. Incavo per la linfa per evitare l'inceppamento. Leva a doppia azione per ridurre lo sforzo richiesto. Attacco regolabile per aste con diametro da 25 mm. Fornito con una corda da 5 mt con maniglia taglio max 30 mm.

RACCOGLITORE FRUTTA GRANDE



Articolo	Lmm	€ Listino	
9683950	117x35	45,00	4

• Raccoglie frutta varia come noci, nocciole, castagne, marroni, ghiande, olive, ecc..

RACCOGLITORE FRUTTA PICCOLO



Articolo	Lmm	€ Listino	
9683930	101x30	40,00	6

• Raccoglie frutta varia come noci, nocciole, castagne, marroni, ghiande, olive, ecc..

RACCOGLI FRUTTO CON SACCHETTO



Articolo	Lmm	€ Listino	
9683110	160	3,10	20
9686155	Manico rastrello	2,55	100

• Raccogli frutta con sacchetto cestello cesta raccoglitore olive. Particolarmente indicato per la raccolta di fichi d'india.

FORBICE PER ERBA GIREVOLE



Articolo	Lmm	€ Listino	
9173200	340	8,00	12

• Un meccanismo di precisione a molla assicura l'allineamento delle lame. Il meccanismo a leva consente di esercitare il minimo sforzo durante il taglio. Le lame possono essere regolate in tre diverse angolazioni in base alle necessità consentendo di raggiungere anche i punti più difficili. Le lame sono destinate solo a tagliare erba.

FORBICE PER ERBA FISSA



Articolo	Lmm	€ Listino	
9173150	320	2,50	12

• Un meccanismo di precisione a molla assicura l'allineamento delle lame. Il meccanismo a leva consente di esercitare il minimo sforzo durante il taglio. Le lame possono essere regolate in tre diverse angolazioni in base alle necessità consentendo di raggiungere anche i punti più difficili. Le lame sono destinate solo a tagliare erba.

TAGLIAERBA GS-76



Articolo	Lmm	€ Listino	
9661950	340	18,40	12

• Tagliaerba con lame temprate, autoaffilanti durante l'uso. Un meccanismo di precisione a molla assicura l'allineamento delle lame. Le lame possono essere regolate in tre diverse angolazioni in base alle necessità consentendo di raggiungere anche i punti più difficili. Le lame sono destinate al solo taglio dell'erba.

RICAMBI BAHCO



LAMA P16 R116V



Articolo	€ Listino	
9662005	38,60	3

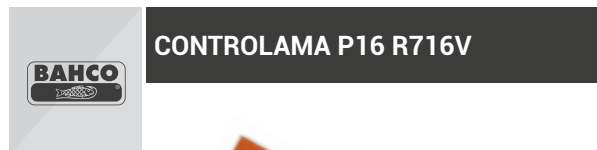

CONTROLAMA P16 R716V



Articolo	€ Listino	
9662025	38,00	12

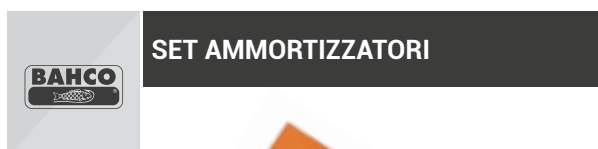

SET AMMORTIZZATORI



Articolo	€ Listino	
9662075	7,50	1



**BULLONI E DADI PER MANICI
P16 - P14 - R615V**



Articolo	€ Listino	
9662065	13,20	5

• Ricambio per: P16,P14,P19, P55,P57,P60-60,P180, R515VS

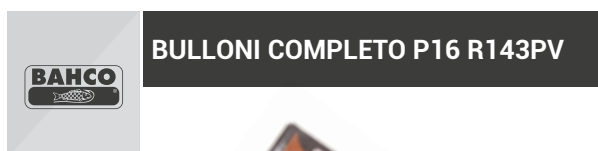

BULLONI COMPLETO P16 R143PV



Articolo	€ Listino	
9662045	9,72	1

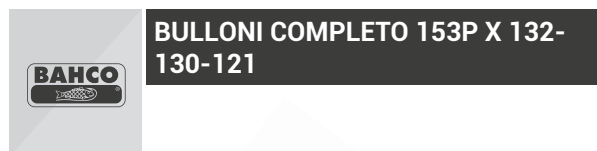



**BULLONI COMPLETO 153P X 132-
130-121**



Articolo	€ Listino	
9661470	6,00	5

BAHCO
BULLONI COMPLETO P1-20, P2-20, P6-20, P-126



Articolo	€ Listino	
9662330	12,30	5

BAHCO
BULLONI COMPLETO P3, P5, P108, P110



Articolo	€ Listino	
9662340	7,05	3

BAHCO
MOLLA+AMMORTIZZATORE+2 COPERCHIETTI P3,P95,P108,P110, R1068



Articolo	€ Listino	
9662345	8,60	10

BAHCO
LAMA E SPINOTTO P3-20, P5-20, R112PG



Articolo	€ Listino	
9662290	16,20	2

BAHCO
LAMA E SPINOTTO PER P130-22



Articolo	€ Listino	
9661455	9,85	3

BAHCO
LAMA PER PAM 520



Articolo	€ Listino	
9661648	10,35	5

BAHCO
LAMA E SPINOTTO P34-27A, P108-23, P110-2, 3R124 PG



Articolo	€ Listino	
9662305	24,60	1

BAHCO
LAMA E SPINOTTO P3-23, P5-23, R122PG



Articolo	€ Listino	
9662295	25,66	1



Per informazioni tecniche, foto e prezzi aggiornati visita il nostro sito www.cillisrl.com



Articolo	€ Listino	
9661649	2,07	15

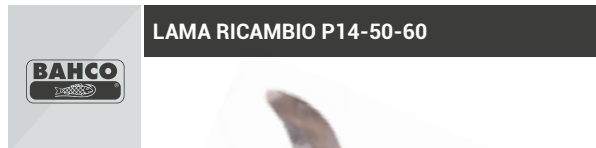

Articolo	€ Listino	
9661655	8,74	3



Articolo	€ Listino	
9172015	13,45	15

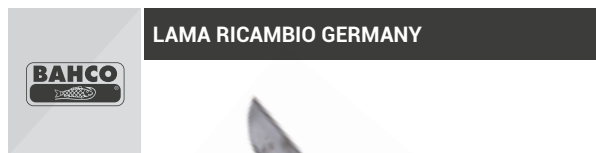

Articolo	€ Listino	
9700510	6,00	12



Articolo	€ Listino	
9662030	26,00	1



Articolo	€ Listino	
9662280	67,18	1

• Ricambio per P123/P128



Articolo	€ Listino	
9179120	0,15	100



Articolo	€ Listino	
9661300	1,42	15

• Ricambio per: P121-P3-P5-P108-P110

AFFILALAME MULTI-SHARP

• Questo nuovo affilalame renderà i vostri utensili affilati e facili da usare. Se usato con forbici, coltelli e troncaremi, garantisce un taglionetto che preserverà la pianta. Usato di tanto in tanto, questo affilalame manterrà i bordi taglienti dei nostri attrezzi.



PRO

Articolo	€ Listino	
9660110	6,50	25

PIETRA PER AFFILARE DOPPIA LAMA

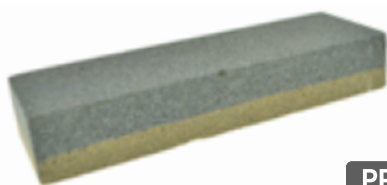

PRO

Articolo	Lmm	€ Listino	
9873206	150x50	1,76	50

PIETRA COTI GRIGIA



PRO

Articolo	Lmm	€ Listino	
9700305	225	3,00	60

AFFILALAME SHARP-X



Articolo	€ Listino	
9660115	19,40	10

SET AFFILA LAME



PRO

Articolo	Lmm	€ Listino	
9700335	150x50x25	4,00	48

• Può essere usato manualmente oppure fissandolo a banco tramite l'apposito supporto.

PIETRA COTI AUSTRIA ROSSA



PRO

Articolo	Lmm	€ Listino	
9700315	225	3,50	60

CINTURA TUTTO CUOIO EXTRA

CILLI|TEK|||



VERA PELLE

Articolo	Lcm	€ Listino	
9660215	120x3	11,40	12
9660217	130x3	11,60	12

CINTURA TUTTO CUOIO

CILLI|TEK|||



VERA PELLE

Articolo	Lcm	€ Listino	
9660210	120x3	6,10	24
9660212	130x3	6,30	24

CINTURA TUTTO CUOIO LUX NERA

CILLI|TEK|||

• Cintura in vero cuoio, con cucitura perimetrale



VERA PELLE

Articolo	Lcm	€ Listino	
9660205	130x4	15,90	12

FODERO PER FORBICE TIPO PUGLIA IN VERA PELLE

CILLI|TEK|||



VERA PELLE

Articolo	€ Listino	
9660180	7,20	20

Per informazioni tecniche, foto e prezzi aggiornati visita il nostro sito www.cillisrl.com

**FODERO PER FORBICE UNI
IN VERA PELLE**

CILLI TEK III



VERA PELLE

Articolo	€ Listino	
9660170	7,20	20

**FODERO PER FORBICE SIOUX
IN VERA PELLE**

CILLI TEK III



VERA PELLE

Articolo	€ Listino	
9660190	7,52	20

**FODERO PER FORBICE MULTIUSO
IN VERA PELLE**

CILLI TEK III



VERA PELLE

Articolo	€ Listino	
9660195	7,20	20

**FODERO PER FORBICE PNEUMATICA
IN VERA PELLE**

CILLI TEK III



VERA PELLE

Articolo	€ Listino	
9660185	12,30	6

**FODERO PER RONCOLA NORMALE
IN VERA PELLE**

CILLI TEK III



VERA PELLE

Articolo	Lmm	€ Listino	
9660176	280	6,80	24

• Adatta alle nostre roncole: 9681416-9681420-9681430
Attenzione colorazioni miste non selezionabili.

**CESOIA A BATTERIA BLACK BRUMI DOPPIA
BATTERIA AL LITIO**

Brumi



NEW

Articolo	Taglio	€ Listino	
9659960	max 25 mm	524,90	1

CARATTERISTICHE

Potenza	16,8V
Batterie a litio	16,8V2Ah
Carica	AC110V-220V
Durata carica	1-1,5 ore
Ore di lavoro	3-4
Potenza nominale	100W
Potenza massima	500W
Peso totale	900gr
Apertura massima lama	25mm



CESOIA A BATTERIA PV280

ORIGINALE
VOLPI2 BATTERIE
INCLUSE

NEW

Articolo	Taglio	€ Listino	
9659940	20-22 mm	342,00	1

CESOIA A BATTERIA RED BURG



NEW

Articolo	Taglio	€ Listino	
9659950	28 mm	524,90	1

- Doppia apertura della lama, opzione antitaglio.

CESOIA A BATTERIA PV400
CON ZAINO BATTERIA AL LITIOORIGINALE
VOLPI

NEW

Articolo	Taglio	€ Listino	
9659970	32-35 mm	898,20	1

CESOIA E-KUT CON ZAINO
A BATTERIA AL LITIO

NEW

Articolo	Taglio	€ Listino	
9659980	40-75 mm	1.075,00	1



CARATTERISTICHE

Tensione batteria	14,4 V
Intensità di corrente	2.0 Ah
Motore brushless	150 watt
Peso netto	680 grammi
Peso della batteria	250 grammi
Autonomia media	+2 ore per batteria
Tempi di ricarica	120 minuti
Lame	Acciaio intercambiabili

CARATTERISTICHE

Tensione batteria	16,8 V
Intensità di corrente	2.0 Ah
Tensione caricabatterie	220V / 50 Hz
Potenza nominale	100 watt
Potenza massima	500 Watt
Peso netto (senza batteria)	500 grammi
Peso della batteria	300 grammi
Peso lordo imballo	2 Kg
Autonomia media	2-3 ore per batteria
Tagli al minuto	fino a 135 tagli
Tempi di ricarica	2 ore

CARATTERISTICHE

Tensione batteria	44 V
Intensità di corrente	4.4 Ah
Motore brushless	300 watt
Peso netto	900 grammi
Peso della batteria	1600 grammi
Autonomia media	8-10 ore
Tempi di ricarica	5-6 ore
Lame	Acciaio intercambiabili

Taglio progressivo e regolazione dell'apertura delle lame in tutte le posizioni.

CARATTERISTICHE

Marcatura CE	Conforme
Livello prodotto	Professionale
Doppia apertura lama	0 - 40 mm / 75 mm
Diametro di taglio max	45 mm
Lame	In speciale lega
Peso utensile	950 gr
Batteria in dotazione	Litio-ioni 185W inclusa
Peso batteria	1.100 gr
Autonomia Batteria	1 giorno
Tempo medio di ricarica	3 ore
Tipo di Motore	DC a induzione
Potenza	190 Watt

FORBICI E-KUT professionali per la potatura di frutteti, oliveti, vigna e per il giardinaggio in genere, mettono a disposizione una grande potenza di taglio unita ad elevata precisione e praticità d'uso.

Taglio Servo Assistito con sistema di sicurezza Safe Kut.



FORBICE PNEUMATICA ST-360K

Articolo	Taglio	€ Listino	
9701750	29 mm	90,00	2



**FORBICE PNEUMATICA ST-360K
CON PROLUNGA TELESCOPICA**

Articolo	Taglio	€ Listino	
9701765	29 mm	200,00	1

• Asta telescopica 137-247 cm



FORBICE PNEUMATICA SUPERLEGGERA

Articolo	Kg	Ø	L/min	Bar	€ Listino	
9700888	0,520	32	80	8-10	180,60	1



**FORBICE PNEUMATICA SUPERLEGGERA
CON ADATTATORE**

Articolo	Kg	Ø	L/min	Bar	€ Listino	
9700904	0,494	32	80	8-10	159,20	1



FORBICE PNEUMATICA VICTORY MF 500

Articolo	Kg	Ø	L/min	Bar	€ Listino	
9700886	0,510	32	80	9	194,60	1



FORBICE PNEUMATICA STAR 40

Articolo	Kg	Ø	L/min	Bar	€ Listino	
9700890	0,675	40	100	10	248,72	1



**FORBICE SUPER STAR DT
PNEUMATICA DOPPIO TAGLIO**

Articolo	Kg	Ø	L/min	Bar	€ Listino	
9700883	0,610	30	80	10	213,60	1



ADATTATORE FORBICE PNEUMATICA

Articolo	€ Listino	
9700938	28,00	3

• Per Cobra - SuperStar - Blak Star - Victory

KIT MANUTENZIONE POTATORE AUTOLUBE



Articolo	€ Listino	
9700929	31,50	1

• Per Cobra - SuperStar - Blak Star - Victory

ADATTATORE FORBICE F4 PNEUMATICA



Articolo	€ Listino	
9700892	47,00	1

SEGA PNEUMATICA CON BARRA 8" 1/4 CON SERBATOIO



Articolo	€ Listino	
9700980	480,00	1
9700959	Adattatore sega 34,40	3



SEGA PNEUMATICA CON BARRA CARVING 8" CATENA 1/4 SENZA SERBATOIO LINX



Articolo	€ Listino	
9700964	456,00	1
9700959	Adattatore sega 34,40	3



SEGA PNEUMATICA CON BARRA 10" 1/4



Articolo	Barra	€ Listino	
9700984	10" 1/4	480,40	1



SEGA PNEUMATICA CON BARRA CARVING 8" CATENA 1/4 CON SERBATOIO



Articolo	Barra Carving	€ Listino	
9700978	8" 1/4	530,40	1



RICAMBI FORBICI PNEUMATICHE

CORPO PER SEGA PNEUMATICA BARRA CARVING 8" CATENE 1/4"



Articolo	€ Listino	
9700964A	125,00	1

• Ricambio per 9700964

KIT INTERNO VALVOLA FORBICE VICTORY



Articolo	€ Listino	
9700934	16,61	1

KIT LAMA MOBILE FORBICE VICTORY



Articolo	€ Listino	
9700927	35,01	1

PERNO VALVOLA + O.R. FORB. PNEUMATICA



Articolo	€ Listino	
9700918	5,20	1

ALBERINO VALVOLA+O.R. FORBICE PNEUMATICA



Articolo	€ Listino	
9700919	7,00	1

TAPPO CIECO NERO + O.R. FORBICE PNEUMATICA



Articolo	€ Listino	
9700902	4,50	1

• Ricambio per P16, P14, P55, P57, P60-60, P180, R515VS

MOLLA CORPO VALVOLA FORBICE PNEUMATICA



Articolo	€ Listino	
9700903	2,08	1

GRUPPO PISTONE BIELLA FORBICE PNEUMATICA



Articolo	€ Listino	
9700923	52,00	3

KIT GUARNIZIONI FORBICE PNEUMATICA



Articolo	€ Listino	
9700920	11,70	1

**MOLLA RITORNO PISTONE
FORBICE PNEUMATICA**



Articolo	€ Listino	
9700924	5,90	1

**DADO M10X1
FORBICE PNEUMATICA**



Articolo	€ Listino	
9700917	3,40	1

**LAMA MOBILE
FORBICE PNEUMATICA**



Articolo	€ Listino	
9700910	39,60	1

**PERNO CENTRALE LAME
FORBICE PNEUMATICA**



Articolo	€ Listino	
9700909	13,28	1

RIVETTO D6 FORBICE PNEUMATICA



Articolo	€ Listino	
9700916	4,10	1

LAMA FISSA FORBICE PNEUMATICA



Articolo	€ Listino	
9700911	28,60	1

KIT GUARNIZIONI FORBICE VICTORY



Articolo	€ Listino	
9700933	6,86	1

ADATTATORE SEGA PNEUMATICA



Articolo	€ Listino	
9700959	34,40	3

• Per 9700980 - 9700958

Per informazioni tecniche, foto e prezzi aggiornati visita il nostro sito www.cillisrl.com



Articolo	Kg	€ Listino	
9680060	0,600	12,60	12



Articolo	Kg	€ Listino	
9681070	0,600	6,90	12



Articolo	Kg	€ Listino	
9681160	0,600	9,50	24



Articolo	Lmm	Kg	€ Listino	
9681105	900	1,600	17,00	12



Articolo	Lmm	Kg	€ Listino	
9681110	870	1,500	25,00	8
9681120	870	2,000	27,00	8



Articolo	Lmm	Kg	€ Listino	
9684125	900	2,500	25,00	12
9684135	900	3,000	28,00	12
9684145	900	3,500	36,00	12
9686521	Manico ricambio		13,80	20



Articolo	Kg	€ Listino	
9681390	2,000	8,50	12
9681400	2,500	10,00	12



Articolo	Lmm	€ Listino	
9681920	625	5,30	48

- Lunghezza lama 480 mm
- Spessore lama 1,8-2,0 mm

MACETE INVERSO MANICO LEGNO



Articolo	Lmm	€ Listino	
9681940	457	5,95	24

MACETE DRITTO MANICO LEGNO



Articolo	Lmm	€ Listino	
9681930	457	5,85	24

MACETE EXTRA BLAK PRO



Articolo	Lmm	€ Listino	
9681910	630	21,00	4

MACETE 2 IN 1



Articolo	Lmm	€ Listino	
9681905	600	15,00	12

MARRACCIO LAZIALE
MANICO PLASTICA



Articolo	Lmm	€ Listino	
9681520	390	10,00	12

- Lunghezza lama 250 mm
- Spessore lama 4 mm

RONCOLA ULIVI
CON CANNA INOX



PRO

Articolo	€ Listino	
9681565	13,00	2
9686150	Manico rastrello 135 cm 2,40	25
9686155	Manico rastrello 150 cm 2,55	25
9686180	Manico rastrello 175 cm 3,16	25

PENNATO SENZA MANICO



Articolo	Lmm	€ Listino	
9681460	300	10,00	12
9686150	Manico rastrello 135 cm	2,40	100
9686155	Manico rastrello 150 cm	2,55	100
9686180	Manico rastrello 180 cm	3,16	100

- Lunghezza lama 230 mm
- Spessore lama 4 mm

RONCOLA ABRUZZO MANICO LEGNO



Articolo	Lmm	€ Listino	
9681540	500	13,00	12

- Lunghezza lama 300 mm
- Spessore lama 3 mm

Per informazioni tecniche, foto e prezzi aggiornati visita il nostro sito www.cillisrl.com



**RONCOLA TIPO SOLITO
MANICO CUIO LAMA INOX**

PRO

Articolo	Lmm	Tipo	€ Listino	
9681416	415	Sfuso	19,80	24
9681417	415	Blister	20,00	24



**RONCOLA TIPO SOLITO
MANICO CUIO**

Articolo	Lmm		€ Listino	
9681420	415	0,730	15,98	12

- Lunghezza lama 295 mm
- Spessore lama 4 mm



**RONCOLA PROFESSIONALE
MANICO IN CUIO**

CILLITEK III

PRO

Articolo	Lmm	€ Listino	
9681430	407	19,74	10



**PENNATO RIETI
MANICO LEGNO**

CILLITEK III

PRO

Articolo	Lmm	€ Listino	
9681500	240	19,20	10

- Attrezzi professionali in acciaio di alta qualità forgiati a mano per un taglio e una resistenza superiore.
- Manico in legno



**MACETE PROFESSIONALE
MANICO LEGNO CON CUSTODIA**

CILLITEK III

PRO

Articolo	Lmm	€ Listino	
9681900	495	33,96	6

- Attrezzi professionali in acciaio di alta qualità forgiati a mano per un taglio e una resistenza superiore. Manico in legno. Custodia con passatoio per cinghia.

Lunghezza lama - 35,5 cm ; Lunghezza manico - 14 cm; Spessore superiore lama - 3 mm; Spessore inferiore lama -2,8/1,9 mm.



**RONCOLA PROFESSIONALE
CON MANICO FERRO A TUBO**

CILLITEK III

PRO

Articolo	Lmm	€ Listino	
9681470	360	19,74	10
9686138	1350	3,55	100

- Attrezzi professionali in acciaio di alta qualità forgiati a mano per un taglio e una resistenza superiore. Manico in ferro a tubo professionale.



FALCIOLA LISCIA FORGIATA N°2

UBURG
www.uburgtools.com
PROFESSIONAL

Articolo	Lmm	€ Listino	
9685108	245	6,60	24

- Lunghezza manico 13 cm



FALCIOLA DA CANTONIERE N°3

UBURG
www.uburgtools.com
PROFESSIONAL

Articolo	Lama Lmm	€ Listino	
9685137	335x40	10,20	25

- Lunghezza impugnatura: 360 mm
- Larghezza impugnatura: 25 mm

FALCIOLA SPAGNA



Articolo	Lmm	€ Listino	
9685143	500	3,06	24
9685145	525	4,00	24

FALCIOLA CEREALI DENTATA



Articolo	Lmm	€ Listino	
9685155	350	2,10	24
9685158	400	2,50	24
9685165	450	2,60	24
9685170	500	2,75	24

FALCE CON BARBA STRETTA



Articolo	Lmm	€ Listino	
9685261	600	9,40	12

FALCE CON BARBA STRETTA



PRO

Articolo	Lmm	€ Listino	
9685264	600	12,00	12

MANICO PER FALCE CON ANELLO SUPERIORE

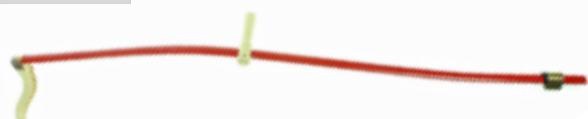

PRO

Articolo	Lcm	€ Listino	
9685290	150	12,80	10

KIT RICAMBI MANICO PER FALCE CON ANELLO SUPERIORE



Articolo	€ Listino	
9685291	6,00	12

PINZA INNESTATRICE UNIVERSALE

• La pinza è adatta per gli innesti su tutti i tipi di piante, viene fornita con tre tipi di lame. Lama incastro, lama omega e lama a U. Tutte le lame in dotazione sono di acciaio temprato.

PRO

Articolo	€ Listino	
9700450	25,00	6
9700451	Lama incastro 2,50	6
9700453	Lama Omega 2,50	6
9700452	Lama U 2,50	6

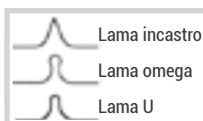

MASTICE INNESTI

Articolo	Kg	€ Listino	
8103020	0,250	5,10	48
8103050	0,500	6,36	48
8103100	1,000	11,00	48



COLTELLO INNESTO EXTRA



PRO

Articolo	Lmm	Tipo	€ Listino	
9700750	160	Sfuso	7,90	36

COLTELLO INNESTO EXTRA CON PALETTA



PRO

Articolo	Lmm	Tipo	€ Listino	
9700760	200	Sfuso	8,20	36

COLTELLO INNESTO EXTRA CURVO



PRO

Articolo	Lmm	Tipo	€ Listino	
9700810	170	Sfuso	8,00	36
9700815	170	Blister	8,20	36

RONCOLA APERTA PROFESSIONALE



PRO

Articolo	Lmm	Tipo	€ Listino	
9700860	140	Sfuso	7,10	24
9700865	140	Blister	7,30	24
9700870	160	Sfuso	7,80	24
9700875	160	Blister	8,00	24
9700880	180	Sfuso	8,30	24

COLTELLO A RONCOLA PROFESSIONALE



PRO

Articolo	Lmm	Tipo	€ Listino	
9700850	180	Sfuso	7,50	24
9700855	180	Blister	7,80	24

RONCOLETTA UNIVERSALE



Articolo	Lmm	€ Listino	
9860000	95	3,66	12



COLTELLO MULTIUSO CON CUSTODIA



Articolo	€ Listino	
9860092	3,50	24

cilli

COLTELLO FRANCESE



Articolo	Lmm	€ Listino	
9860016	177	6,00	12

COLTELLO INNESTO CON PALETTA



Articolo	Lmm	€ Listino	
9700762	165	6,50	30

COLTELLO INNESTO EXTRA



Articolo	Lmm	€ Listino	
9700752	165	8,00	24

COLTELLO PROFESSIONALE LOCALE



Articolo	Lmm	€ Listino	
9860018	158	6,70	12

COLTELLO PROF ZUAVA



Articolo	Lmm	€ Listino	
9860020	160	7,10	12

COLTELLO PROFESSIONALE CALABRESE



Articolo	Lmm	€ Listino	
9860022	165	6,60	12

COLTELLO MULTIUSO KL 211



Articolo	Lmm	€ Listino	
9860028	180	6,60	24

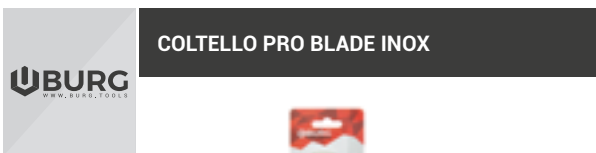

INOX

Articolo	Lmm	€ Listino	
9700802	210	10,80	24



Articolo	Lmm	€ Listino	
9700738	190	3,00	24

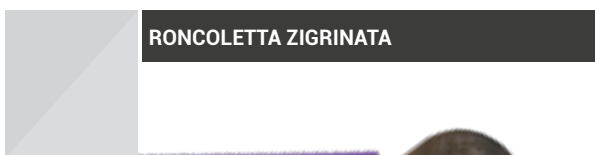

Articolo	Lmm	€ Listino	
9700739	160	3,00	24



• Legatrice manuale professionale ideale per la legatura dei tralci a tutori, utilizza nastri in PVC di facile impiego, permette un notevole risparmio di tempo in agricoltura e floricoltura.

La pinza legatrice realizza legature resistenti in modo del tutto istantaneo e con un solo e semplice movimento. Si tratta di una pinza molto semplice, leggera e facile da utilizzare.

Con l'aiuto della mano si appone il nastro sulla parte dove si vuole ottenere la legatura, dopodichè si appoggia la pinza legatrice sul tralcio da allacciare e la si preme in modo da attorcigliare, tagliare e graffettare il nastro, chiudendolo.

PRO

Articolo	Lmm	€ Listino	
9700020	50	45,00	10



PRO

Articolo	Lmt	Spessore	€ Listino	
9700055	40	0,10 mm	4,20	30



PRO

Articolo	Lmt	Spessore	€ Listino	
9700070	26	0,15 mm	4,20	30

NASTRO ROSSO CONFEZIONE 10 PZ



PRO

Articolo	Lmt	Spessore	€ Listino	
9700060	16	0,25 mm	4,20	30

CONFEZIONE 10.000 PUNTI PER LEGATRICE

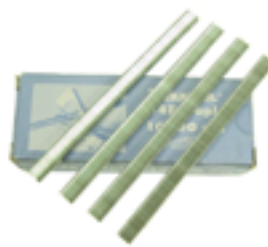

PRO

Articolo	Tipo	€ Listino	
9700045	604E	4,40	100

CONFEZIONE 5.040 PUNTI PER LEGATRICE



Articolo	Tipo	€ Listino	
9700040	604E	3,30	100

LAMETTE PER LEGATRICE



Articolo	€ Listino	
9700090	1,04	100

RAFFIA SINTETICA IN CONETTI

• Prezzo al Kg
Ideale per legature sulle piante e per innesti.



Articolo		Colore	€ Listino	
0680150	0,200	Verde	7,84	10Kg
0680155	0,200	Bianco	7,84	10Kg

RAFFIA SINTETICA

• Prezzo al Kg
Ideale per legature sulle piante e per innesti.



Articolo	Lcm	Colore	€ Listino	
0680100	100	Bianco	7,84	15Kg
0680120	100	Verde	7,84	15Kg
0680130	120	Bianco	7,84	15Kg
0680140	120	Verde	7,84	15Kg

SET 3 TUBICINI PVC GIALLO



Articolo	Lmm	€ Listino	
0670309	1,2 x 15 mt	1,30	48

DISPENSER FILO PLASTIFICATO



Articolo	Lmt	Ø	€ Listino	
0670376	30	1,2	1,00	72
0670377	30	1,4	1,30	72



Per informazioni tecniche, foto e prezzi aggiornati visita il nostro sito www.cillisrl.com

TUBICINO LEGAVITI MATASSA VERDE



PLASTICA VERGINE

Articolo	Ø	€ Listino	
0670050	3	4,40	50Kg

• Prezzo al Kg

TUBICINO LEGAVITI MATASSA GIALLO



PLASTICA VERGINE

Articolo	Ø	€ Listino	
0670040	2,2	4,40	50Kg
0670060	4	4,40	50Kg
0670070	6	4,40	50Kg

• Prezzo al Kg

TUBICINO LEGAVITI GOMITOLI



PLASTICA VERGINE

Articolo	Ø	Colore	€ Listino	
0670100	2,0	Verde	4,40	50Kg
0670102	3,0	Verde	4,40	50Kg
0670104	4,0	Verde	4,40	50Kg
0670106	6,0	Verde	4,40	50Kg

• Prezzo al Kg

TUBICINO LEGAVITI GOMITOLI



PLASTICA VERGINE

Articolo	Ø	Colore	€ Listino	
0670110	2,0	Giallo	4,40	50Kg
0670090	2,5	Giallo	4,40	50Kg
0670095	3,0	Giallo	4,40	50Kg

• Prezzo al Kg

TUBICINO LEGAVITI PRIMA SCELTA A SPEZZONI GIALLO



PLASTICA VERGINE

Articolo	Lmm	Ø	€ Listino	
0670130	300	2,5	4,40	50Kg
0670160	600	6,0	4,40	25Kg
0670173	900	3,0	4,40	25Kg
0670174	900	4,0	4,40	25Kg
0670176	900	6,0	4,40	25Kg

• Prezzo al Kg

PIATTINA CARTA CON ANIMA IN METALLO



Articolo	Lmm	Pz	€ Listino	
0671020	200	1000	2,60	48
0671025	250	1000	3,40	72

PIATTINA PVC CON ANIMA METALLO



Articolo	Lmm	Tipo	€ Listino	
0670212	120	Spezzoni	4,78	30Kg
0670215	150	Spezzoni	4,78	30Kg
0670220	200	Spezzoni	4,78	30Kg
0670225	250	Spezzoni	4,78	30Kg
0670230	300	Spezzoni	4,78	30Kg
0670240	400	Spezzoni	4,78	24Kg
0670260	--	Rotolino 500g	3,14	48Kg

• Prezzo al Kg

PIATTINA ANIMATA BLISTER



Articolo	Lmt	€ Listino	
0670355	50	1,60	144
0670360	100	2,44	144

PIATTINA ANIMATA PLASTIFICATA

Articolo	Lmt	Ø	€ Listino	
0670372	50	2,3	1,40	72



DISPENSER FILO ZINCATO

Articolo	Lmt	Ø	€ Listino	
0670380	50	0,5	1,50	72
0670385	50	0,7	1,70	72
0670390	50	1,0	2,00	72
0670395	50	1,2	2,50	72



KIT 30 MATASSINE FILO FERRO VERDE PLASTIFICATO

Articolo	N°	Lmt	Ø	€ Listino	
8110125	4	30	0,09	33,06	2
8110130	6	20	1-1,4	33,06	2
8110135	8	16	1-1,6	33,06	2
8110150	14	7	1,5-2,5	33,06	2



KIT 30 MATASSINE FILO FERRO COTTO ZINCATO

Articolo	N°	Lmt	Ø	€ Listino	
8110035	8	20	1,30	26,44	2
8110040	10	15	1,50	26,44	2
8110045	12	11	1,80	26,44	2
8110050	14	7	2,20	26,44	2





AGRI & GARDEN



ZAPPA OCCHIO OVALE



Articolo	Lcm	Kg	Ømm	€ Listino	
9682085	19x12	0,740	40x33	7,50	25
9686128	Manico ovale			4,80	100

ZAPPA OCCHIO OVALE



Articolo	Lcm	Kg	Ømm	€ Listino	
9682105	22,5x12,5	0,950	40x33	6,00	25
9686128	Manico ovale			4,80	100

ZAPPA OCCHIO TONDO



Articolo	Kg	€ Listino	
9682150	0,600	7,00	25
9686100	Manico tondo		100
9682160	0,800	7,50	25
9686106	Manico tondo		100

ZAPPA OCCHIO TONDO SPAGNA



Articolo	Kg	€ Listino	
9682040	0,400	7,20	25
9686100	Manico tondo		100
9682060	0,600	7,25	25
9686106	Manico tondo		100
9682080	0,800	8,50	25
9682100	1,100	10,00	25
9686115	Manico tondo		100

ZAPPA OCCHIO TONDO



Articolo	Kg	€ Listino	
9682140	0,950	7,00	25
9686118	Manico tondo		100

ZAPPA CALABRIA OCCHIO QUADRO



Articolo	Kg	€ Listino	
9682340	0,600	8,00	25
9682350	0,800	9,00	25
9682360	1,000	9,40	25
9686195	Manico quadro		100
9682370	1,200	12,00	25
9686196	Manico quadro		100

ZAPPA OCCHIO QUADRO TIPO LECCE



Articolo	Kg	€ Listino	
9682320	0,850	10,00	25
9686106	Manico tondo		100
9682330	1,100	11,00	25
9686195	Manico quadro		100

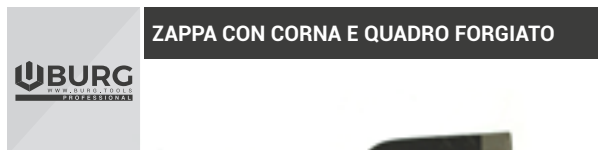

ZAPPA CON CORNA E QUADRO FORGIATO

Articolo	LCcm	LZcm	kg	Ømm	€ Listino	
9683290	11x6,5	11,5x8	0,350	30	6,00	25
9686100	Manico tondo				3,50	100

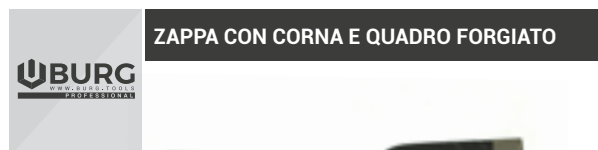

ZAPPA CON CORNA E QUADRO FORGIATO

Articolo	LCcm	LZcm	kg	Ømm	€ Listino	
9683298	11x6	11x7,5	0,500	30	7,50	25
9686100	Manico tondo				3,50	100



ZAPPA CAMPIDANO OCCHIO OVALE
TEMPRATA AD OLIO

Articolo	LCcm	LZcm	kg	Ømm	€ Listino	
9682230	12,5x8	13x9	0,600	43x33	7,50	25
9682240	15x8,5	15x9,5	0,800	43x33	8,70	25
9682250	16,5x10	16,5x10,5	1,000	43x33	9,20	25
9686128	Manico ovale				4,80	100



ZAPPA CAMPIDANO OCCHIO TONDO
TEMPRATA AD OLIO

Articolo	LCcm	LZcm	kg	Ømm	€ Listino	
9682260	12x7	11x7	0,400	30	7,00	25
9682270	13x8	12,5x7,5	0,600	30	8,00	25
9682280	15,5x8	15x9	0,800	30	9,00	25
9686100	Manico tondo				3,50	100



ZAPPETTA QUADRA E BIDENTE
OCCHIO TONDO

Articolo	kg	Ømm	€ Listino	
9683320	0,300	27-29	3,00	12
9686100	Manico faggio tondo		3,50	100



ZAPPA CON CORNA E CUORE FORGIATO
OCCHIO TONDO

Articolo	LCcm	LZcm	kg	Ømm	€ Listino	
9683300	11,5x6	13x8	0,500	30	6,70	25
9686100	Manico tondo				3,50	100

ZAPPA CUORE E QUADRA



Articolo	LCcm	LZcm	Kg	Ømm	€ Listino	
9683330	--	--	0,300	29/36	3,51	12
9686100	Manico tondo				3,50	100

ZAPPA SCURE TIPO SOLITO



Articolo	Kg	€ Listino	
9684550	1,800	14,00	10
9686220	Manico zappa		100

Lunghezza zappa: 435 mm
 Larghezza parte piatta: 60 mm
 Larghezza parte a punta: 18 mm
 Diametro superiore occhio ovale: 60
 Diametro inferiore occhio ovale: 67

PICCONE OCCHIO OVALE



Articolo	Kg	€ Listino	
9684395	1,500	9,00	12
9686200	Manico piccone		100

Lunghezza piccone: 470 mm
 Lunghezza parte a punta: 210 mm
 Lunghezza parte piatta: 195 mm
 Larghezza parte a punta: 22 mm
 Larghezza parte piatta: 52 mm

ZAPPA TRE CORNA OCCHIO TONDO



Articolo	Kg	€ Listino	
9682190	1,200	11,00	24
9686118	Manico zappa tondo		100

VOMERE



Articolo	Lmm	€ Listino	
9683350	200x300x300	10,00	15
9686158	Manico rastrello		100

Per informazioni tecniche, foto e prezzi aggiornati visita il nostro sito www.cillisrl.com

COLTIVATORE 1 DENTE



Articolo	€ Listino	
9683215	2,00	60

COLTIVATORE 3 DENTI FISSI



Articolo	€ Listino		
9683220	5,00	12	
9686155	Manico rastrello	2,55	100

SARCHIATORE CON LAMA IN CARBONIO



Articolo	Lmm		€ Listino	
9683355	170X25	0,300	3,50	60
9686158	Manico rastrello		2,55	100

SARCHIATORE CON LAMA IN CARBONIO



Articolo	Lmm		€ Listino	
9683360	160x35	0,200	3,40	48
9686155	Manico rastrello		2,55	100

SARCHIATORE CON LAMA IN ACCIAIO



Articolo	Lmm		€ Listino	
9683390	106x160	0,400	4,50	48
9686158	Manico rastrello		2,55	100

ZAPPA PER TUBERI CON LAMA IN CARBONIO



Articolo	Lmm		€ Listino	
9683380	200	0,200	5,00	24
9683385	250	0,250	6,00	24
9686158	Manico rastrello		2,55	100



SARCHIATORE 2 BRACCIA

Articolo	Lmm	Kg	€ Listino	
9683365	150x60	0,300	5,50	24
9686155	Manico rastrello		2,55	100

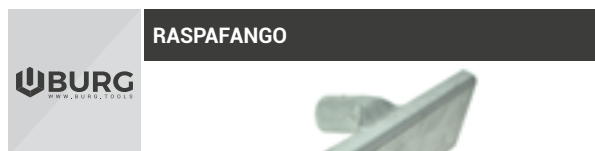

RASPAFANGO

Articolo	Lmm	Kg	€ Listino	
9682510	115X400	1,000	7,40	24
9686138	Manico badile dritto		3,55	100



VANGA MANICATA

Articolo	Lcm	€ Listino	
9682310	102x30x19	15,00	6



VANGA FORGIATA

Articolo	Lmm	€ Listino		
9682301	300x220x115	8,50	20	
9686138	Manico badile dritto		3,55	100



VANGA FORGIATA

Articolo	Lmm	€ Listino		
9682302	185x210x171	8,50	20	
9686138	Manico badile dritto		3,55	100



VANGA TIPO VARESE LAMINATA QUADRA

Articolo	Lmm	Kg	€ Listino	
9683540	285x190	1,100	5,00	24
9686138	Manico badile dritto		3,55	100



VANGA A PUNTA TONDA FORGIATA

Articolo	Lmm	€ Listino		
9682308	395x300x160	10,80	20	
9686138	Manico badile dritto		3,55	100



VANGA A PUNTA FORGIATA

Articolo	Lmm	€ Listino		
9682307	300x220x155	10,00	20	
9686138	Manico badile dritto		3,55	100



BADILE VERNICIATO CON RINFORZO IN LAMIERA STAMPATA

PRO

Articolo	Lmm	Kg	€ Listino	
9684002	290X270	1,000	7,00	20
9686130	Manico badile curvo	3,60		100
9686138	Manico badile dritto	3,55		100



BADILE VERNICIATO IN LAMIERA STAMPATA

PRO

Articolo	Lmm	Kg	€ Listino	
9684001	285x290	1,000	6,00	12
9686130	Manico badile curvo	3,60		100
9686138	Manico badile dritto	3,55		100



BADILE ALLUMINIO

PRO

Articolo	Lmm	Kg	€ Listino	
9684005	275x290	0,400	7,68	14
9686130	Manico badile curvo	3,60		100
9686138	Manico badile dritto	3,55		100
9686135	Manico badile	4,72		100



PALA ALLUMINIO

PRO

Articolo	Lmm	€ Listino	
9683765	390x330	12,00	12
9686135	Manico badile	4,72	100



PALA TEDESCA PER CARBONE

PRO

Articolo	€ Listino	
9684014	N° 4	15
9686138	Manico badile dritto	100

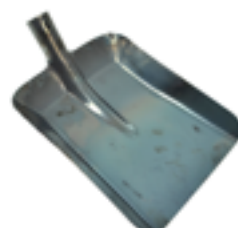

PALA PLASTICA A CUCCHIAIO

PRO

Articolo	Lmm	Kg	€ Listino	
9683770	410X370	0,650	6,76	18
9686130	Manico badile curvo	3,60		100
9686138	Manico badile dritto	3,55		100



PALA PLASTICA A CUCCHIAIO CON PROFILO

PRO

Articolo	Lmm	Kg	€ Listino	
9683775	385x410	0,776	9,30	18
9686130	Manico badile curvo	3,60		100
9686138	Manico badile dritto	3,55		100



SPINGINEVE SENZA PROFILO



Articolo	Lmm	Kg	€ Listino	
9683780	400X500	1,000	7,80	12
9686130	Manico badile curvo	3,60		100

SPINGINEVE CON PROFILO

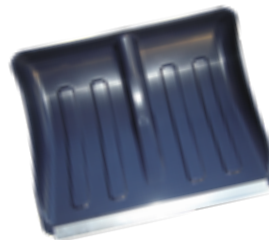

Articolo	Lmm	Kg	€ Listino	
9683782	400X500	1,300	9,80	12
9686130	Manico badile curvo	3,60		100

FORCA ACCIAIO AUSTRIA EXTRA



Articolo	Denti	€ Listino	
9685531	3	6,50	12
9685541	4	7,70	12
9686130	Manico badile curvo	3,60	100

FORCA FORGIATA



Articolo	Denti	Kg	€ Listino	
9685540	4	0,700	10,00	25
9686130	Manico badile curvo	3,60		100

FORCA ACCIAIO DA GHIAIA



Articolo	Denti	€ Listino	
9685570	9	14,00	12
9686130	Manico badile curvo	3,60	100

FORCA ACCIAIO PER UVA E PATATE CON PALLINE ALLE PUNTE



Articolo	Denti	€ Listino	
9685565	6	15,00	12
9686130	Manico badile curvo	3,60	100

FORCA ACCIAIO CURVATA PER UVA CON PALLINE ALLE PUNTE



Articolo	Denti	€ Listino	
9685560	4	12,00	25
9686138	Manico badile dritto	3,55	100



Per informazioni tecniche, foto e prezzi aggiornati visita il nostro sito www.cillisrl.com

COPPIA SANDALI ARIEGGIATORI DA GIARDINO



Articolo	€ Listino	
9174310	11,80	12

• Facili e pratici da usare, ideali per la bucatura del prato. Con chiodi in acciaio temprato sostituibili. Suola in PVC resistente e flessibile. Alloggiamento per il tallone per maggiore stabilità e confort. Fissaggio universale con fibbie regolabili.

AERATORE SU RUOTE CON MANICO



Articolo	Lcm	€ Listino	
9683250	120	42,00	6

• Appoggiando l'aeratore sul prato, i suoi denti aguzzi tenderanno ad affondare nell'erba, ancorandosi saldamente allo strato di detriti e portandolo in superficie.

AERATORE SU RUOTE SENZA MANICO



Articolo	Denti	€ Listino	
9683240	11	40,00	8
9686155	Manico legno rastrello	2,55	100

AERATORE ZINCATO



Articolo	Denti	€ Listino	
9683230	12	4,00	24
9683232	14	6,00	24
9683234	16	7,40	24

AERATORE DOPPIO

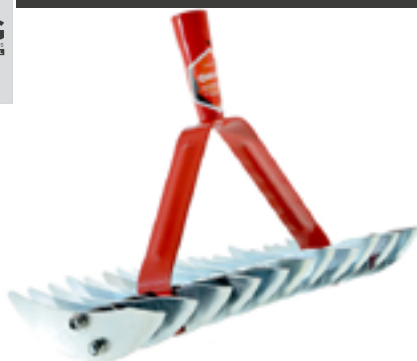

Articolo	Denti	€ Listino	
9683235	11+21	11,00	6
9686155	Manico legno rastrello	2,55	100

• Rastrello 11 + 21 denti aeratore doppio arieggiatore per giardino prato inglese. Con denti zincati disposti su due file opposte. Larghezza 39 cm circa, con attacco conico.

RASTRELLO EXTRA



Articolo	Denti	€ Listino	
9683813	12	3,80	24
9683815	14	4,26	24
9683817	16	5,04	24
9686155	Manico legno rastrello	2,55	100

RASTRELLO ALLUMINIO ATTACCO REGOLABILE



Articolo	Denti	€ Listino	
9683920	20	14,00	24
9683922	22	15,00	24
9683924	24	17,00	24
9686155	Manico legno rastrello	2,55	100

RASTRELLO PER ERBA



Articolo	Denti	€ Listino	
9683880	40	16,00	10
9686155	Manico legno rastrello	2,55	100

RASTRELLO DOPPIO RACCOGLIFOGLIE



Articolo	Lmm	€ Listino	
9683925	900x400x150	30,00	4



**SCOPA REGOLABILE
CON MANICO IN METALLO**

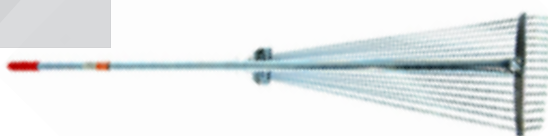

Articolo	Lcm	€ Listino	
9140090	152	7,00	24

- Lunghezza rastrello chiuso: 120 cm
- Larghezza rastrello chiuso: 19 cm
- Lunghezza rastrello aperto: 152 cm
- Larghezza rastrello aperto: 51 cm
- Lunghezza manico: 98 cm.

**SCOPA REGOLABILE
ATTACCO CON MORSETTI**



Articolo	Denti	€ Listino	
9140115		4,50	40
9686155	Manico legno rastrello	2,55	100

**SCOPA REGOLABILE
ATTACCO CONO FE**



Articolo	Denti	€ Listino	
9140120		4,00	40
9686155	Manico legno rastrello	2,55	100

SCOPA FISSA DA GIARDINO



Articolo	Denti	€ Listino	
9140125		3,40	30
9686155	Manico legno rastrello	2,55	100

**SCOPA PER FOGLIE E OLIVE
TRIANGOLARE RINFORZATA**



Articolo	Denti	€ Listino	
9140150	20	2,70	25

- Attacco conico

SCOPA PER OLIVE CON RINFORZO



Articolo	Denti	€ Listino	
9140135	23	4,00	60
9171040	Asta telescopica	13,00	12

Per informazioni tecniche, foto e prezzi aggiornati visita il nostro sito www.cillisrl.com

SCOPA PROF NYLON GIALLLO



Articolo	Denti	€ Listino	
9140170	21	6,16	100
9686155	Manico legno rastrello	2,55	100

FORCA PER LETAME VERDE HORSE FORK



Articolo	Denti	Lmm	€ Listino	
9140185	16	440x425	9,75	20
9686155	Manico legno rastrello	2,55		100

FORCA PER LETAME NERO HORSE FORK



Articolo	Denti	Lmm	€ Listino	
9140180	20	440x425	8,30	25
9686160	Manico legno con buco	3,30		25

MANICO LEGNO FORCA CON BUCO



Articolo	Ø	Lcm	€ Listino	
9686160	24x27mm	140	3,30	25

• Solo per forca 9140180

PALETTA GRANDE ORTEN BURG



Articolo	Lmm	€ Listino	
9170070	300	5,36	12

• Manico ergonomico bicomponente soft

PALETTA MEDIA ORTEN BURG



Articolo	Lmm	€ Listino	
9170080	300	5,20	12

• Manico ergonomico bicomponente soft

ZAPPETTA ORTEN BURG



Articolo	Lmm	€ Listino	
9170090	300	5,50	12

• Manico ergonomico bicomponente soft

SARCHIATORE ORTEN BURG



Articolo	Lmm	€ Listino	
9170100	300	4,50	12

• Manico ergonomico bicomponente soft

FORCA 3 DENTI MANICO LEGNO LUNGO



Articolo	Lmm	€ Listino	
9683314	500X100	3,00	24

• Manico ergonomico bicomponente soft

MANICO FAGGIO TONDO

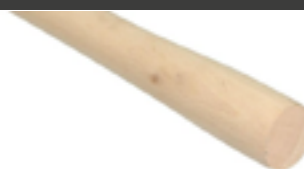

Articolo	Ø	Lcm	€ Listino	
9686100	25x32mm	130	3,50	25
9686106	29x36mm	130	3,64	25

MANICO PER ZAPPA QUADRO FAGGIO



Articolo	Ø	Lcm	€ Listino	
9686195	40x40mm	130	4,06	25
9686196	45x45mm	130	4,80	25

MANICO ZAPPA TONDO FAGGIO

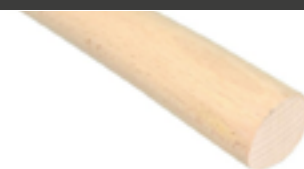

Articolo	Ø	Lcm	€ Listino	
9686115	33x40mm	130	4,00	25
9686118	37x52mm	130	5,00	25

MANICO OVALE FAGGIO



Articolo	Ø	Lcm	€ Listino	
9686125	35x45mm	140	5,14	25
9686128	38x50mm	130	4,80	25

MANICO PER PICCONE OCCHIO OVALE FAGGIO

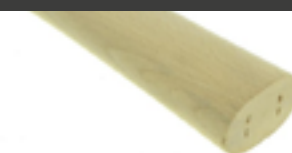

Articolo	Ø	Lcm	€ Listino	
9686200	40x58mm	100	3,55	25

MANICO PER MAZZA SCURE FAGGIO

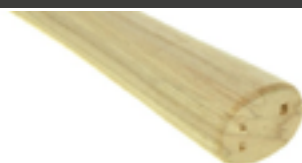

Articolo	Ø	Lcm	€ Listino	
9686210	37x51mm	100	3,55	25
9686220	67x45mm	90	5,60	25

MANICO BADILE

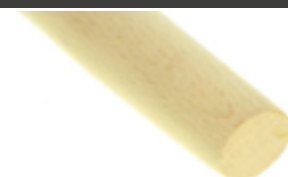

Articolo	Tipo	Lcm	€ Listino	
9686130	Curvo faggio	135	3,60	25
9686135	Curvo leggero pioppo	140	4,72	25
9686138	Dritto faggio	135	3,55	25

Per informazioni tecniche, foto e prezzi aggiornati visita il nostro sito www.cillisrl.com

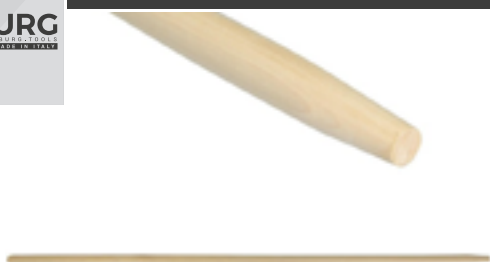

Articolo	Lcm	€ Listino	CFM
9686150	135	2,40	25
9686155	150	2,55	25
9686180	175	3,16	25

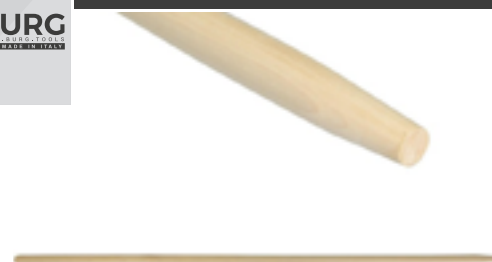

Articolo	Lcm	€ Listino	CFM
9686158	150	2,55	25

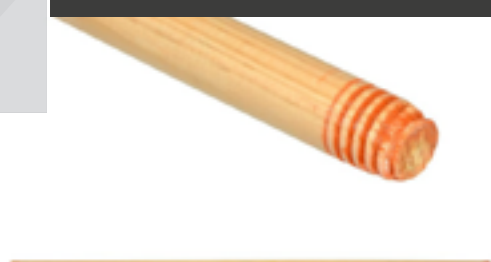

Articolo	Lcm	€ Listino	CFM
9686175	120	1,86	25

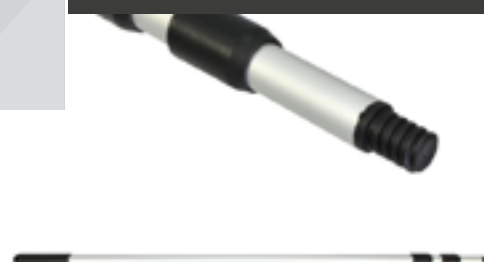

Articolo	Lcm	€ Listino	CFM
9171040	115-300	13,00	12

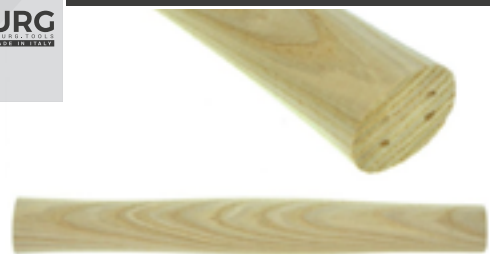

Articolo	Ø	Lcm	€ Listino	CFM
9686320	30x40mm	30	1,26	25

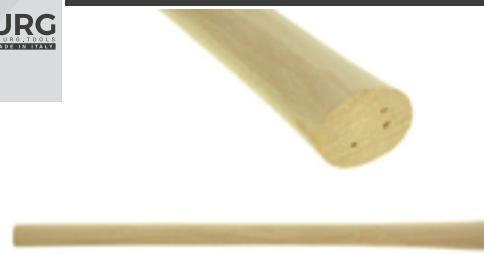

Articolo	Ø	Lcm	€ Listino	CFM
9686340	27x37mm	40	1,16	25
9686330	30x40mm	51	1,30	25



MANICO LIMA



Articolo	Lcm	€ Listino	
9686410	10	0,66	200
9686420	14	0,86	200

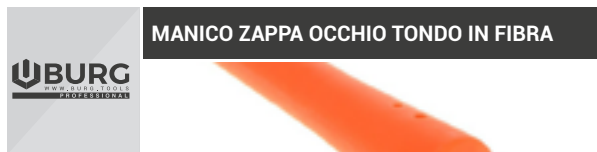

MANICO ZAPPA OCCHIO TONDO IN FIBRA



Articolo	Ø	Lcm	€ Listino	
9686710	40mm	100	12,50	20
9686720	40mm	110	13,00	20



MANICO PICCONE OCCHIO OVALE IN FIBRA



Articolo	Ø	Lcm	€ Listino	
9686511	38x55mm	90	14,20	20

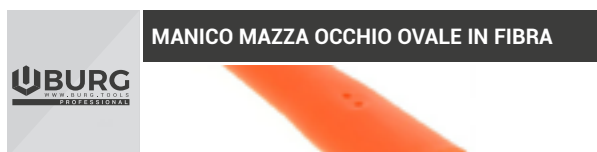

MANICO MAZZA OCCHIO OVALE IN FIBRA



Articolo	Ø	Lcm	€ Listino	
9686521	31x50mm	90	13,80	20



MANICO BADILE OCCHIO TONDO IN FIBRA



Articolo	Ø	Lcm	€ Listino	
9686605	30mm	140	16,00	20



MANICO PER RASTRELLO IN FIBRA



Articolo	Ø	Lcm	€ Listino	
9686530	22-32mm	153	15,00	20



CILLI **TEK**

VANGATRICE MANUALE A LEVA

• La vangatrice manuale a leva è stata ideata e realizzata per piccoli appezzamenti di terra o giardini, dove non si possiedono, o non è possibile l'accesso con attrezzi motorizzati, è destinata a svolgere la mansione del dissodamento del terreno, che consiste nell'introdurre la forca nel terreno per una profondità di circa 30 cm e praticando una leva, permette di strappare le zolle e gettarle all'indietro.



Articolo	Lcm	€ Listino	
9683120	110x41	154,00	1

CILLI **TEK**

PIANTA CANNE SALVA SCHIENA

Utile-Pratico-Innovativo-Brevettato

Pianta di tutto fino ad uno spessore di 38mm.

Lunghezza totale: 60cm

Lunghezza staffa poggiapiede: 8cm

INSERIMENTO



ESTRAZIONE



Articolo	€ Listino	
9683186	20,00	12

CILLI **TEK**

PIANTA CANNE SALVA SCHIENA MAXI

Utile-Pratico-Innovativo-Brevettato

Diametro minimo 30 mm

Diametro massimo 55 mm

Lunghezza totale 75 cm

Larghezza staffa poggiapiede 8 cm



Articolo	€ Listino	
9683188	24,00	12

CILLITEK III

SBANCALATORE SMONTA BANCALI

Pratico utensile sbancalatore utile ad evitare sforzi con la schiena. Con pochi gesti si possono smontare bancali di qualsiasi misura. Basta inserire un manico idoneo togliere i chiodi con la forza apposta, e utilizzarle entrambe per sfilare le tavole.
MANICO NON COMPRESO



Articolo		€ Listino	
9683184		26,00	12
9686100	Manico ricambio	3,50	25

SEMINATRICE VELOCE

INTRODUZIONE

Questo strumento è adatto per il terreno coltivato, è adatto per i semi grandi come mais, fagioli, piselli e così via. Questo attrezzo è in grado di seminare e anche di fertilizzare, se avete acquistato il modello con doppio tubo (articolo 9683201). L'efficienza è 4-5 volte superiore rispetto al lavoro manuale.

UTILIZZO

Mettete i semi nel box di carico semi, o mettere il fertilizzante nel box per carico fertilizzante (nel modello in cui è previsto). Usando le mani per rendere la seminatrice, inserire la bocca (la bocca semi e la bocca fertilizzante) nel terreno, quindi fare leva sulla base di supporto, la pressione farà aprire le bocche.



1. Regola la quantità di semi rilasciata tramite la linguetta dosa semi



2. Fertilizzante (regolare la quantità)



3. Regolare la profondità di semina.



4. Regolare le diverse dimensioni dei semi, inserendo il rullo semi adatto

UBURG
WWW.UBURGTTOOLS

SEMINATRICE VELOCE A TUBO

• Questo strumento è adatto per la semina in terreni coltivati e morbidi, in particolare su terreni sabbiosi, è adatto per i semi grandi come mais, fagioli, piselli e così via. Può seminare fino a 8000 semi ogni giorno, l'efficienza è 4-5 volte superiore al lavoro manuale. E' particolarmente consigliato per le zone collinari, dove non è possibile utilizzare grandi macchine.

Articolo	€ Listino	
9683191	50,00	3

UBURG
WWW.UBURGTTOOLS

SEMINATRICE FERTILIZZATRICE VELOCE A TUBO

• Questo strumento è adatto per seminare e fertilizzare in terreni coltivati e morbidi, in particolare su terreni sabbiosi, è adatto per i semi grandi come mais, fagioli, piselli e così via. Può seminare fino a 8000 semi ogni giorno, l'efficienza è 4-5 volte superiore al lavoro manuale. E' particolarmente consigliato per le zone collinari, dove non è possibile utilizzare grandi macchine.

Articolo	€ Listino	
9683201	60,00	3





SEMINATRICE EASY A TUBO

• Questo strumento è adatto per il terreno coltivato e morbido, in particolare su terreni sabbiosi. Profondità di inserimento nel terreno regolabile.



Articolo	□	Lcm	€ Listino	📦
9683206	2x2cm	94	20,00	12



PIANTATORE VELOCE 3 BOCCHE

• Ideali per piantare : piantine, bulbi e semi ; velocemente e senza mal di schiena. Semplice da usare, basta inserire il piantatore nel terreno, inserire la piantina o altro nel tubo , premere la leva di apertura delle bocche e togliere il piantatore tenendo premuta la leva . Riduce di molto i tempi di piantagione.



Articolo	∅	Lcm	€ Listino	📦
9683209	7cm	92	50,00	3



PIANTATORE VELOCE 2 BOCCHE

• Ideali per piantare : piantine, bulbi e semi ; velocemente e senza mal di schiena. Semplice da usare, basta inserire il piantatore nel terreno, inserire la piantina o altro nel tubo , premere la leva di apertura delle bocche e togliere il piantatore tenendo premuta la leva . Riduce di molto i tempi di piantagione.



Articolo	∅	Lcm	€ Listino	📦
9683212	7cm	101	50,00	4





Articolo	Lmm	€ Listino	
9683155	300	2,50	48



Articolo	Lmm	€ Listino	
9683175	290	2,08	25



Articolo	€ Listino	
9683960	7,50	24

• Adatto per spargere comodamente : sale, semi, concime, ecc.
E' possibile scegliere 2 diverse misure di dosaggio.

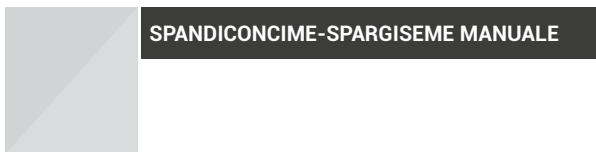

Articolo	Litri	€ Listino	
9601325	12	20,00	6



Articolo	Litri	€ Listino	
9601310	12	38,00	6



Articolo	Lmm	€ Listino	
9683160	300	6,50	25



Articolo	Lmm	€ Listino	
9683180	230	4,00	12

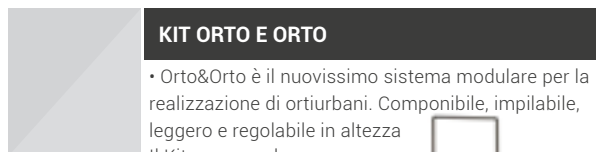

KIT ORTO E ORTO

• Orto&Orto è il nuovissimo sistema modulare per la realizzazione di ortiurbani. Componibile, impilabile, leggero e regolabile in altezza
Il Kit comprende:
3 vasche con fondo
1 struttura per rampicanti.



Articolo	Lcm	€ Listino	
8000000	52,7x45,4x19	81,33	2



Per informazioni tecniche, foto e prezzi aggiornati visita il nostro sito www.cillisrl.com

ROTOLO PRATO VERDE

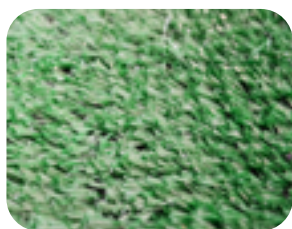

Articolo	Dimensioni cm	€ Listino	
4005105	100x 1 x 25 mt	150,00	1

• Prezzo al rotolo.

RETE OMBREGGIATA VERDE COPERTURA 90%



Articolo	Lmt	€ Listino	
4004820	1x100	55,00	4
4004830	1,5x100	87,60	4
4004840	2,0x100	106,00	4
4004850	3,0x100	159,00	4
4004860	4,0x100	212,00	4
4004940	4x5 Confezionata	19,40	6

SET 100 PZ GANCIO PER RETE OMBREGGIANTE



Articolo	€ Listino	
4004890	24,00	15

TELONE OCCHIELLATO HOBBY COLORE INTERNO BLU ESTERNO VERDE

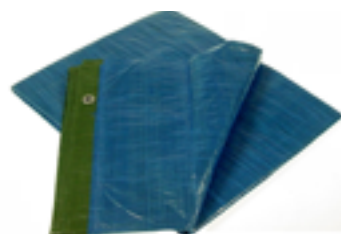

Articolo	Lmt	€ Listino	
4001230	2x3	3,58	40
4001340	3x4	7,14	20
4001450	4x5	11,88	40
4001460	4x6	14,26	10

• Occhielli su tutto il perimetro

TELONE OCCHIELLATO STANDARD COLORE INTERNO BLU ESTERNO VERDE

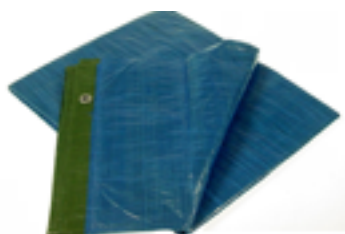

Articolo	Lmt	€ Listino	
4002230	2x3	4,14	40
4002330	3x3	6,21	30
4002340	3x4	8,28	30
4002350	3x5	10,35	15
4002360	3x6	12,42	15
4002440	4x4	11,14	15
4002450	4x5	13,80	15
4002460	4x6	16,76	10
4002470	4x7	19,32	10
4002560	5x6	20,70	8
4002580	5x8	27,60	8
4002690	6x10	41,40	4
4002800	8x10	55,20	4
4002810	8x12	66,24	2
4002950	8x15	82,80	2

• Occhielli su tutto il perimetro
• Peso 90 grammi per Mq

TELONE OCCHIELLATO PESANTE COLORE VERDE

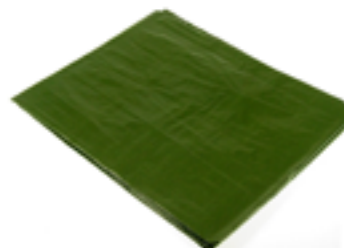

Articolo	Lmt	€ Listino	
4004230	2x3	6,24	30
4004330	3x3	9,36	20
4004340	3x4	12,48	15
4004350	3x5	15,60	12
4004360	3x6	18,72	10
4004440	4x4	16,64	10
4004450	4x5	20,80	10
4004460	4x6	24,96	8
4004560	5x6	31,20	6
4004580	5x8	41,60	4
4004680	6x8	49,92	3
4004690	6x10	62,40	3
4004810	8x10	83,20	2

• Occhielli su tutto il perimetro
• Peso 120 grammi per Mq

TELO COPRITUTTO POLIETILENE



Articolo	Lmt	Kg	€ Listino	
9825000	4x4	0,100	0,96	200
9825005	4x4	0,150	1,24	210
9825006	4x4	0,260	1,42	210

ESTENSIBILE IN LEGNO



Articolo	Lmt	Colore	€ Listino	
4300415	1x2	Verde	4,40	10
4300425	1,5x2	Verde	5,00	10
4300430	1x3	Naturale	6,00	10

TELONE OCCHIELLATO ANTISTRAPPO COLORE BLU



Articolo	Lmt	€ Listino	
4003340	3x4	26,52	8
4003350	3x5	33,15	5
4003360	3x6	39,78	6
4003450	4x5	44,20	5
4003460	4x6	53,04	4
4003560	5x6	66,30	4
4003570	5x7	77,35	2
4003580	5x8	88,40	2
4003800	8x10	176,80	1



• Occhielli su tutto il perimetro • Peso 200 grammi per Mq

TELO PACCIAMATURA VERDE 1X100 M



Articolo	Ltm	€ Listino	
0650915	1x100	84,00	1

• Tessuto per la pacciamatura robusto e poroso, in polipropilene stabilizzato ai raggi UV. 100 grammi al metro quadro.

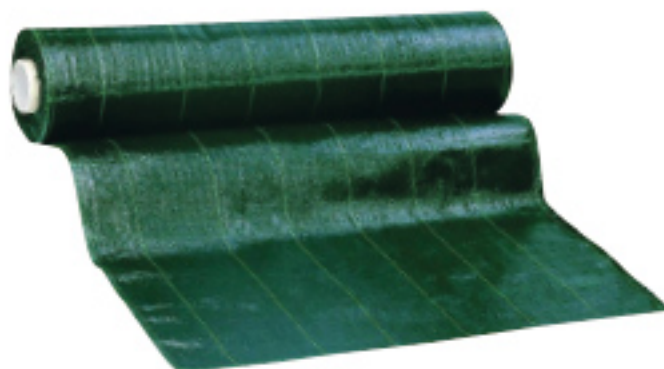

TELO PACCIAMATURA VERDE

PRO

Articolo	Lmt	€ Listino	
0650910	1x100	97,00	3

• Tessuto per la pacciamatura robusto e poroso, in polipropilene stabilizzato ai raggi UV. 100 grammi al metro quadro.



Per informazioni tecniche, foto e prezzi aggiornati visita il nostro sito www.cillisrl.com

RETE SOSTEGNO VEGETALI ROTOLI



Articolo	Lmt	€ Listino	
4050015	1,5x50	16,40	6
4050018	1,5x100	25,85	4
4050025	1,7x50	16,80	6
4050028	1,70x100	27,30	4
4050117	1,7x1000	185,00	1
4050120	2,0x1000	219,00	1

• Maglia 150x170 mm

RETE SOSTEGNO VEGETALI CONFEZIONATA



Articolo	Lmt	€ Listino	
4050012	1,5x10	4,06	48
4050022	1,7x10	4,22	48
4050032	2x10	4,50	48

• Maglia 150x170 mm

RETE ANTI-UCCELLI



Articolo	Lmt	€ Listino	
4050505	2x5	3,65	48
4050510	2x10	6,10	48
4050525	4x5	6,10	48
4050530	4x10	10,08	48

RETE ANTI GRANDINE



Articolo	Lmt	€ Listino	
4050550	3x100	151,00	3

• Rete antigrandine tessuta in HDPE a trama semplice.

TESSUTO TNT



Articolo	Lmt	€ Listino	
4053010	1,6x5	2,06	100
4053015	1,6x10	3,36	50
4053020	2,4x10	5,32	36

CONFEZIONE TESSUTO TNT TUBOLARE



Articolo	Lmt	Pz conf.	€ Listino	
4053030	0,6x0,8	6	2,40	90
4053035	1,0x1,6	3	2,94	60

Prezzo riferito a 1 confezione

FILO PROFESSIONALE

Articolo	Ø	Lmt	€ Listino	
0520170	3,0 mm	1550	11,40	10Kg
0520190	4,0 mm	870	11,40	10Kg
0520205	5,0 mm	500	11,40	10Kg



SET 100 MORSETTI PER FILO NYLON



Articolo	Ø	€ Listino	
0520202	3,0 mm	13,50	10
0520204	4,0 mm	15,90	10

MORSETTO BLOCCAFILO



Articolo	Ton	Lmm	€ Listino	
0507510	0,5	1-10	34,60	4
0507520	1,0	2,6-15	51,80	4
0507530	2,0	2-22	66,70	4

PARANCO CAVETTO ACCIAIO



Articolo	Tipo	€ Listino	
0507300	Piccolo/tondo	22,00	6

PARANCO CAVETTO ACCIAIO



Articolo	Tipo	€ Listino	
0507400	Medio/quadro	41,00	4

MORSETTO TIRAFILO



Articolo	N°	Tipo	€ Listino	
0507560	2	Zincato	1,08	200
0507570	3	Zincato	1,16	200
0507600	2	Plastificato	0,76	200
0507650	3	Plastificato	0,88	200

MORSETTO TIRAFILO PROF



PRO

Articolo	N°	Tipo	€ Listino	
0507572	2	Zincato	1,28	200
0507575	3	Zincato	1,50	200

• Morsetto tirafilo per agricoltura
Corpo in Acciaio FE 360 B - Rullino in ghisa.

PARANCO TIRAFILO DOPPIO CAVO



Articolo	Ton	€ Listino	
0507505	1	80,00	6

• Lunghezza cavo 410 - 1210 mm - diametro cavo 5 mm.

PARANCO ALZATIRA ORIZZONTALE



Articolo	Ton	Kg	€ Listino	
0510600	2	1000/2000	30,00	4
0510610	4	4000/8000	40,80	4

• Lunghezza 0510600 cavo 110 - diametro cavo 5 mm.
Lunghezza 0510610 cavo 140 - diametro cavo 5 mm.

Per informazioni tecniche, foto e prezzi aggiornati visita il nostro sito www.cillisrl.com

ARGANO CON CAVO



Articolo	Kg	€ Listino	
0510972	900	27,00	4

• Fune in polipropilene diam. 7 mm, alzata da ml 0,5 a ml 2,50, struttura in acciaio zincato, 2 ganci di sicurezza e sistema a tre carrucole. Pulegge carrucole in plastica diametro 50 mm. Lunghezza cavo 18 metri. Ganci di sicurezza 60 mm.

ANCORE CON OCCHIELLO ZINCATE A CALDO



Articolo	Tondino	Lcm	€ Listino	
0508060	10mm	60x10	4,38	100
0508110	10mm	80x12	6,20	100
0508210	12mm	80x12	6,34	100
0508310	14mm	120x16	11,00	100

SET 4 GANCI SICUREZZA



Articolo	Lmm	€ Listino	
9849720	60x2 - 80x2	2,00	50

SET 2 GANCI



Articolo	Lmm	€ Listino	
9849725	40x4	1,00	144

SET 2 GANCI



Articolo	Lmm	€ Listino	
9849726	60x6	1,00	72

GANCIO



Articolo	Lmm	€ Listino	
9849728	80x8	1,00	48

MOSCHETTONI POMPIERE



Articolo	Lmm	€ Listino	
0530010	40	0,40	200
0530020	50	0,42	200
0530030	60	0,60	200
0530040	80	0,70	100
0530050	100	1,20	60
0530060	120	1,68	60
0530070	140	2,20	40
0530080	160	3,40	20

MAGLIE GIUNZIONE PER CATENE



Articolo	Lmm	€ Listino	
0530820	40	0,36	200
0530830	50	0,44	200
0530840	60	0,54	200
0530850	70	0,72	100
0530860	80	0,94	100
0530870	100	1,26	100
0530880	120	2,00	80

GRILLI DIRITTI ZINCATI



Articolo	Lmm	€ Listino	
0530100	50	0,42	200
0530110	60	0,46	200
0530120	80	0,64	200
0530130	100	0,90	90
0530140	120	1,40	60
0530150	140	2,12	50
0530160	160	3,44	30
0530170	180	4,16	25
0530180	200	5,16	20

MORSETTI ZINCATI



Articolo	Lmm	€ Listino	
0530200	30	0,14	500
0530220	50	0,16	500
0530230	60	0,18	500
0530240	80	0,22	500
0530250	100	0,38	200
0530260	120	0,72	100
0530270	140	0,80	100
0530280	160	1,10	80

TENDITORE A DUE OCCHI



Articolo	Lmm	€ Listino	
0530310	50	0,86	100
0530320	60	0,94	100
0530330	80	1,30	90
0530340	100	1,74	60
0530350	120	2,50	40
0530360	140	4,00	40
0530370	160	5,26	30

GANCI CON SICURA



Articolo	kg	€ Listino	
0530410	250	2,10	100
0530420	500	3,88	50
0530430	1000	8,80	25
0530440	1600	14,40	10

MOSCHETTONI REDINI



Articolo	Tipo	€ Listino	
0530955	Piccolo	0,70	50
0530960	Medio	0,90	50
0530950	Grande	1,00	50

MOSCHETTONI SIMPLEX NICHELATI



Articolo	Lmm	€ Listino	
0530905	40	0,28	200
0530910	50	0,32	100
0530915	60	0,46	100
0530920	70	0,62	60
0530925	80	0,80	60

PORTACHIAVI



Articolo	€ Listino	
9989628	0,87	96

9 GANCI PORTATUTTO



Articolo	Lmm	€ Listino	
9982056	70	1,50	48

Per informazioni tecniche, foto e prezzi aggiornati visita il nostro sito www.cillisrl.com

4 GANCI PORTATUTTO



Articolo	Lmm	€ Listino	
9982050	90	1,50	72

4 GANCI PORTATUTTO



Articolo	Lcm	€ Listino	
9982057	140	2,00	72

SPATOLONI DOPPIA GOMMA

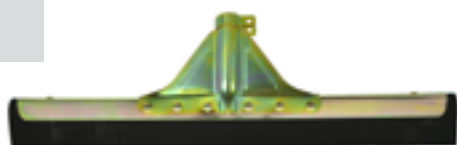

Articolo	Lcm	€ Listino		
9140075	45	4,20	--	30
9140078	55	5,40	--	30
9140080	75	8,90	--	30
9686155	Manico rastrello	2,55	--	100

SPAZZETTONE INDUSTRIALE PIUMATO



Articolo	Lcm	€ Listino	
9140028	40	4,53	12
9140030	60	6,00	12
9140035	80	8,49	12
9140040	100	9,80	12
9686155	Manico rastrello	2,55	100

SPAZZETTONE INDUSTRIALE NON PIUMATO



Articolo	Lcm	€ Listino	
9140065	40	4,62	12
9140066	60	6,60	12
9140068	80	9,00	12
9686155	Manico rastrello	2,55	100

SCOPA INDUSTRIALE



Articolo	Tipo	Supporto	€ Listino	
9140016	Piumata	Legno	2,31	10
9140018	Piumata	Plastica	2,17	10
9140015	Non piumata	Legno	2,31	10
9686175	Manico scopa		1,86	100

SCOPA GARDEN IN PLASTICA



Articolo	Lcm	Kg	€ Listino	
9140073	53,5X87	0,520	6,00	20

SCOPA SPAZZOLINO FLOU

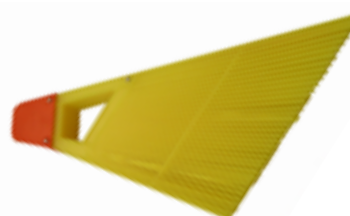

Articolo	Lcm	Kg	€ Listino	
9140055	30	0,500	7,80	13
9686175	Manico scopa		1,86	100

SCOPA SPAZZINO PLASTICA A FILI



Articolo	Lcm	€ Listino	
9140071	54	7,25	6
9686175	Manico scopa	1,86	100

• Attacco filettato

CONFEZIONE SACCHI BIO COMPOST



Articolo	Pz conf.	Lcm	€ Listino	
9217150	15	42x43	2,18	63
9217155	10	53x60	2,22	24

• Prodotto biodegradabile e compostabile conforme alla norma. Europea UNI EN 13432

CONFEZIONE SACCHI ROSA LDPE PROFUMATI



Articolo	Pz conf.	Lcm	€ Listino	
9217170	15	55x65	1,26	48

• COEX 3 strati di resistenza. Ideali per la raccolta differenziata.

CONFEZIONE SACCHI AZZURRI HDPE



Articolo	Pz conf.	Lcm	€ Listino	
9217160	10	55x65	1,04	48
9217175	15	70x100	1,32	48

• COEX 3 strati di resistenza. Ideali per la raccolta differenziata.

CONFEZIONE SACCHI VERDI LDPE

• Linea professionale extra forte.



Articolo	Pz conf.	Lcm	€ Listino	
9217205	10	80x115	3,22	30
9217202	10	90x115	3,98	24

SACCHI AZZURRI HDPE 15 PZ PROFUMATI



Articolo	Lcm	€ Listino	
9217162	55x65	1,26	2

SACCHI VERDI LDPE 15 PZ PROFUMATI



Articolo	Lcm	€ Listino	
9217172	55x65	1,26	2

Per informazioni tecniche, foto e prezzi aggiornati visita il nostro sito www.cillisrl.com

**CONFEZIONE DA 10 PZ
SACCHI PER MACERIE**



Articolo	Cm	€ Listino	
9217225	75X100	4,35	30

CONFEZIONE DA 500 PZ SHOPPERS



Articolo	Cm	Micron	€ Listino	
9217210	23+13x41	14	27,55	4
9217215	27+14x50	16	39,15	4
9217220	30+16x60	19	67,89	2

Shoppers biodegradabili e compostabili per asporto merci colore bianco 4,8 gr/busta.

PALETTA ZINCATA PIANA



Articolo	€ Listino	
8580110	3,30	32

**ALZAIMMONDIZIA ZINCATO TIPO PENSATE
CON MANICO IN METALLO**



Articolo	€ Listino	
8580120	6,50	24

**KIT 3 CONTENITORI
PER RACCOLTA DIFFERENZIATA**



Articolo	Lcm	€ Listino	
9826460	51x30x48	44,80	1

SACCO PER RIFIUTI



Articolo	Lcm	€ Listino	
8610033	45x60	6,30	12

BIDONE IN LAMIERA ZINCATA

Articolo	Litri	€ Listino	
8580122	18	16,00	12
8580125	35	22,80	8
8580130	62	33,00	8



SECCHIO ZINCO ECO LEGGERO



Articolo	Litri	€ Listino	
8580153	8	5,50	40
8580155	10	7,00	40
8580175	16	8,00	40

• Non per liquidi

SECCHIO ZINCO PESANTE



Articolo	Litri	€ Listino	
8580160	10	10,00	24
8580170	12	12,00	24

• Non per liquidi

BANDERUOLA A GALLO PUNTI CARDINALI



Articolo	€ Listino	
9687160	6,34	6

OMBRELLONE LATERALE



Articolo	Lcm	€ Listino	
9687155	230x250	100,00	1

STAZIONE METEOROLOGICA



Articolo	Lcm	€ Listino	
5190400	150	15,00	10

GRATICOLA RIBALTABILE



Articolo	Lcm	€ Listino	
9732095	30x40	16,20	8

MAJELLA

LA FORNACELLA

100% MADE IN ABRUZZO

CUOCI ARROSTICINI

IN ACCIAIO INOX



FORNACELLA MAJELLA 1000 INOX PER ARROSTICINI



Articolo	Lcm	€ Listino	
9720100	100x15x19	140,00	1



FORNACELLA MAJELLA 500 DOPPIA INOX



Articolo	Lcm	€ Listino	
9720300	50x30x19	158,00	1



Con elemento centrale per arrostitini



Senza elemento centrale per arrosto

FORNACELLA MAJELLA 500 INOX PER ARROSTICINI



Articolo	Lcm	€ Listino	
9720500	50x15x19	114,00	1



FORNACELLA MAJELLA CAMINO INOX PER ARROSTICINI



Articolo	Lcm	€ Listino	
9720333	33,5x15x19	46,00	1



ACCENDITORE ECOLOGICO 32 CUBI



Articolo	€ Listino	
9731050	1,38	40

SET 4 ATTREZZI BARBECUE PROFESSIONALE



SET 3 ATTREZZI BARBECUE



Articolo	€ Listino	
9740800	24,40	12

Articolo	€ Listino	
9740700	3,80	12

SPAZZOLA PER BARBECUE



GRATICOLA A RETE CON PIEDI



Articolo	Tipo	€ Listino	
9875100	Corto	1,86	24
9875102	Lungo	2,00	24

Articolo	Lcm	€ Listino	
9732020	40x45	14,80	5

GRATICOLA TONDINO CON PIEDI



Articolo	Lcm	€ Listino	
9732050	40x35	14,40	6
9732060	50x35	17,80	6



MACCHINE AGRI E GARDEN



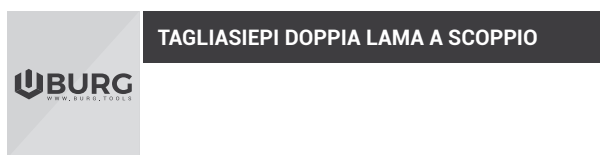

CARATTERISTICHE	
Potenza	1,3 Hp - 0,9 Kw/ 6500 RPM
Cilindrata	22,5 cc
Carburante	Miscela 4%
Taglio	600 mm
Peso	7 Kg

Articolo	€ Listino	
9601730	220,00	1



CARATTERISTICHE	
Motore	2 tempi raffreddato ad aria
Cilindri	1
Potenza	1600 W - 1,5 kW
Cilindrata	51.7 cc
Velocità massima del motore	9000 ± 500 rpm
Sistema di accensione	CDI
Candela di accensione	L8RTF
Motorino avviamento	A contraccolpo
Capacità serbatoio	1,2 litri
Lubrificante scatola ingranaggi	Olio per ingranaggi SEA#80-90
Rapporto riduzione	45:1
Catalizzatore	Si
Punta trivella fornita	80x15 cm
Carburante	Miscela 4%

Articolo		€ Listino	
6118900	Mototrivella	340,00	1
6118905	Punta Ø 10cm	40,00	1
6118908	Punta Ø 15cm	50,00	1
6118910	Punta Ø 20cm	60,00	1





SOFFIATORE ASPIRAFOGLIE ELETTRICO

Articolo	€ Listino	
9770840	70,00	1

CARATTERISTICHE

Potenza	2400 W
Velocità	15000 rpm
Max velocità aria aspirata	270 km/h
Max volume aria	13,2 metri cubi/min
Alimentazione	230 V/ 50 Hz

SOFFIATORE ASPIRATORE
CON SACCO A SCOPPIO EB-260

Articolo	€ Listino	
9770845	270,00	1

CARATTERISTICHE

Peso con tubi e senza miscela	5,4 Kg
Dimensione motore	29x23x35 cm
Tipo motore	2 tempi-raffreddamento ad aria
Corsa e alesaggio	3,4x2,8 cm
Cilindrata	26 cc
Potenza (km/t/min)	0,75/7500
Capacità serbatoio	0,65 lt
Carburante	miscela 4%
Accensione	Elettronica
Avviamento	Autoavvolgente
Volume mq/sec.	0,13
Dimensioni tubo soffiatore	64x7 cm (5 cm estremità)
Dimensioni tubo sacco raccolta	39x7 cm
Dimensioni tubo aspiratore	95x11 cm
Dimensioni sacco	79x49 cm (ingresso per tubo 17x14 cm)



SOFFIATORE SCOPPIO A ZAINO EB-650

Articolo	€ Listino	
9770855	455,00	1

CARATTERISTICHE

Peso senza miscela	11 Kg
Dimensione motore	46,5x36,5x52,5 cm
Tipo motore	2 tempi-raffreddamento ad aria
Corsa e alesaggio	3,5x4,8 cm
Cilindrata	63,3 cc
Velocità aria soffiante	3350 km/h
Volume mq/sec.	0,22
Capacità serbatoio	0,5 lt
Carburante	miscela 4%
Avviamento	Autoavvolgente
Carburatore	a membrana con primer
Giri motore a massimo regime	6800 rpm
Giri motore al minimo	2250-2750 rpm



Per informazioni tecniche, foto e prezzi aggiornati visita il nostro sito www.cillisrl.com



RASAERBA ELETTRICO

Articolo	€ Listino	
9600030	116,00	1

CARATTERISTICHE

Potenza	100 W
Giri max	3200 rpm
Alimentazione	230V-50Hz
Rumore	96 db
Larghezza taglio	300 mm
Altezza taglio regolabile	25-40-55 mm
Cesto di raccolta	25 Litri
Peso	13 Kg



DECESPUGLIATORE 2 TEMPI

Articolo	€ Listino	
9770045	200,00	1

• In dotazione: Disco, testina, bretelle e chiavi

CARATTERISTICHE

Cilindrata	32.8 cc
Potenza	0.8 Kw/7.500 r/min
Diametro albero	26/28 mm
Lunghezza asta	165 cm
Peso	7,5 Kg
Alimentazione	Miscela 4%



DECESPUGLIATORE 2 TEMPI

Articolo	€ Listino	
9770050	240,00	1

• In dotazione: Disco, testina, bretelle e chiavi

CARATTERISTICHE

Cilindrata	41.2 cc
Potenza	1.2 Kw/7.500 r/min
Diametro albero	26/28 mm
Lunghezza asta	165 cm
Peso	8 Kg
Alimentazione	Miscela 4%





DECESPUGLIATORE 2 TEMPI



Articolo	€ Listino	
9770080	250,00	1

• In dotazione: Disco, testina, bretelle e chiavi

CARATTERISTICHE

Cilindrata	43 cc
Potenza	0.9 Kw/10.000 r/min
Diametro taglio	415 mm
Lunghezza asta	162 cm
Peso	7,5 Kg
Alimentazione	Miscela 4%

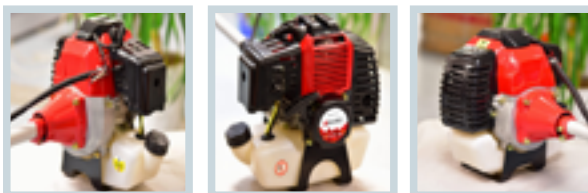

RICAMBI DECESPUGLIATORI

KIT CILINDRO + PISTONE + FASCE



Articolo	€ Listino	
RD00048 CC32	67,00	1
RD00048A CC42	67,00	1

BOBINA PER DECESPUGLIATORE



Articolo	€ Listino	
RD00030 CC32	23,60	6
RD00030A CC42	23,60	6

• RD00030A è adatta anche alla motopompa 6100685

CARBURATORE PER DECESPUGLIATORE



Articolo	€ Listino	
RD00067 CC32	55,00	1
RD00069 CC42	55,00	1

CC42 Adatta anche alla motopompa 6100685

SERBATOIO DECESPUGLIATORE



Articolo	€ Listino	
RA00013	27,00	1

• Per 9770045 - 9770050

Per informazioni tecniche, foto e prezzi aggiornati visita il nostro sito www.cillisrl.com

COPPIA CONICA D.26 9 DENTI



Articolo	€ Listino	
RA00002	36,00	6

• Per 9770045 - 9770050

**FILTRINO+TUBO
BENZINA DECESPUGLIATORE**



Articolo	€ Listino	
RA00011	7,00	1

• Per 9770045 - 9770050

KIT AVVIAMENTO DECESPUGLIATORE



Articolo	€ Listino	
RA00003	22,60	5

• Per 9770045 - 9770050

**SET 2 PZ CANDELA BM6A
PER DECESPUGLIATORE**



Articolo	Filetto	€ Listino	
9770063	14 mm	4,60	12

• Ns modello: BM6A
• Bosch: WS8E
• Champion: CJ11
• Ngk: BPM6A

**MANUBRIO COMPLETO
PER DECESPUGLIATORE**



Articolo	€ Listino	
RA00014	36,00	5

• Per 9770045 - 9770050

COPPIA CONICA PROFESSIONALE UNIVERSALE



PRO

Articolo	€ Listino	
9770008	52,00	6

•Dimensioni adattatori mm: 24 - 25 - 25.4 - 26
Da completare ordinando a parte inserto necessario.



INSERTO PER COPPIA CONICA UNIVERSALE SCANALATO



PRO

Articolo	Denti	€ Listino	
9770012	7	7,75	6
9770014	9	7,75	6
9770016	10	7,75	6

INSERTO PER COPPIA CONICA UNIVERSALE PROFILO STIHL



PRO

Articolo	€ Listino	
9770024	7,75	6

INSERTO PER COPPIA CONICA UNIVERSALE TIPO BLUE BIRD



PRO

Articolo	Lmm	€ Listino	
9770026	6,5	7,75	6

INSERTO PER COPPIA CONICA UNIVERSALE QUADRATO



PRO

Articolo	Lmm	€ Listino	
9770025	5	9,15	6
9770018	5,4	7,75	6
9770022	6	7,75	6

INSERTO PER COPPIA CONICA UNIVERSALE SCANALATO



PRO

Articolo	Denti	€ Listino	
9770028	7	7,75	6
9770027	11	10,23	6

Per informazioni tecniche, foto e prezzi aggiornati visita il nostro sito www.cillisrl.com

TESTINA UNIVERSALE KING





PRO

Articolo	Fili	€ Listino	
9771785	4	23,20	12

TESTINA UNIVERSALE ECO





PRO

Articolo	Fili	€ Listino	
9771790	8	7,36	50

TESTINA UNIVERSALE PROF





PRO

Articolo	Fili	€ Listino	
9771800	8	12,60	24

TESTINA UNIVERSALE PROF TUTTA IN ALLUMINIO

PRO

Articolo	Fili	€ Listino	
9771770	8	26,86	12

TESTINA UNIVERSALE PROF





PRO

Articolo	Fili	€ Listino	
9771805	12	14,70	12

TESTINA ROYAL UNIVERSALE 4 UTILIZZI



Articolo	€ Listino	
9772820	48,40	4

TESTINA MULTIFILO ALLUMINIO UNIVERSALE



Articolo	€ Listino	
9772800	20,24	6

• Con sistema di raffreddamento

TESTINA MULTIFILO ALLUMINIO FRANZ



Articolo	€ Listino	
9772805	40,51	6

• Con sistema di raffreddamento

TESTINA MULTIFILO ALLUMINIO UNIVERSALE



Articolo	€ Listino	
9772810	7,78	6

• Sostituzione senza utensili.

**TESTINA A SPAZZOLA 16 FILI
PER DECESPUGLIATORI**



Articolo	€ Listino	
9772830	22,44	6

• Spazzola universale multifil, con 16 fili. Adatta a tutti i decespugliatori >30cc. Più delicata rispetto alle spazzole in acciaio, garantisce un'eccellente pulizia degli interstizi tra gli autobloccanti ed il pavè.
Peso: 400 gr.

**TESTINA UNIVERSALE PROF
TUTTA IN ALLUMINIO**



Articolo	Fili	€ Listino	
9771780	12	39,80	12

TESTINA UNIVERSALE



• Diametro superiore testina: 72 mm
Altezza testina: 44 mm
Diametro inferiore testina: 54 mm
Diametro attacco: 25,5 mm
Diametro foro: 14,6 mm

Articolo	Fili	€ Listino	
9771720	8	9,20	12

TESTINA DUE FILI SEMIAUTOMATICA

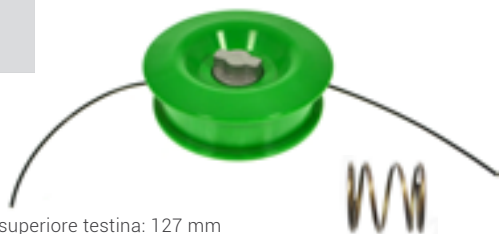

• Diametro superiore testina: 127 mm

Articolo	Tipo	Altezza testina	€ Listino	
9771510	10x1 SF	48	8,82	12
9771540	8x1,25 DF	48	7,28	12
9771545	8x1,25 SF	48	8,20	12
9771590	10x1,5 SF	52	8,70	12
9771900	Molla ricambio		0,57	24

**TESTINA BATTI E VAI UNIVERSALE
RICARICA SENZA SMONTAGGIO**



Articolo		€ Listino	
9772815	359	15,40	10

• Testina batti e vai, attacco universale, ricarica da passafilo senza smontaggio testina. Prodotta in tecnopolimeri ad alta resistenza.

TESTINA UNIVERSALE QUICK LOAD



PRO

Articolo	Fili	€ Listino	
9774150	2	14,42	6

• Si carica inserendo semplicemente lo spezzone di filo nel foro e si blocca automaticamente.

TESTINA BATTI E VAI UNIVERSALE



• Diametro superiore testina: 135,5 mm
Altezza testina: 63 mm
Diametro foro superiore: 24,7 mm
Diametro inferiore testina: 132 mm
Diametro attacco: 58,8 mm

Articolo	Fili	€ Listino	
9771700	2	11,00	30

ROTOTRIM UNIVERSALE



• Diametro superiore testina: 168 mm
Altezza testina: 45 mm
Diametro foro superiore: 71 mm
Diametro foro inferiore: 24,6 mm

PRO

Articolo	Lamelle	€ Listino	
9774000	3	12,94	12
9774050	Lamella ricambio Ø 10	0,54	100
9774055	Lamella ricambio Ø 12	0,54	100

Per informazioni tecniche, foto e prezzi aggiornati visita il nostro sito www.cillisrl.com

PASSAFILO RICAMBIO TESTINE

Articolo	Lmm	Tipo	€ Listino	
9771925	Foro 5-larg.12-h8,5	B	1,50	24
9771950	Foro 5-larg.16-h8	C	0,84	24
9771930	Foro 5-larg.12-h8	D	1,24	24
9771935	Foro 5-larg.12-h12	E	0,98	24
9771945	Foro 5-larg.12-h8	B	0,84	24
9771955	Foro 6-larg.14-h9	F	0,84	24
9771960		G	1,35	24
9771970	Foro 5-larg.13-h13	H	1,36	24

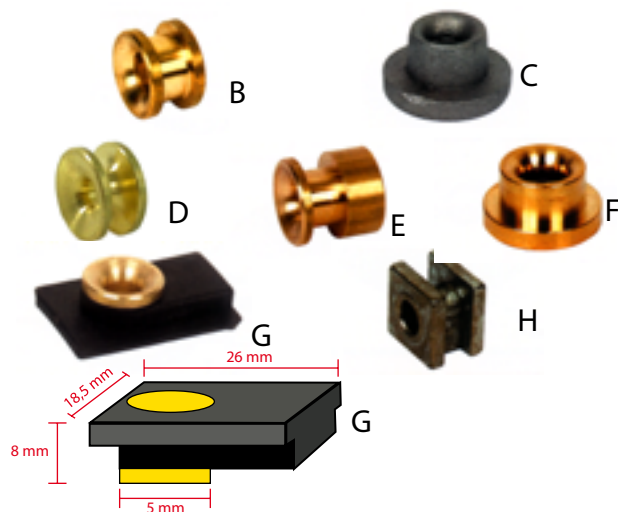

FILO PENTA ORO ALTISSIMA RESISTENZA CON ALLUMINIO



Articolo	Ø	Lmt	€ Listino	
9771150	3,0	15	3,74	100
9771165	3,3	15	4,46	100

Tecno polimero con alluminio. Taglio superiore. Alta tecnologia



FILO PENTA ORO ALTISSIMA RESISTENZA CON ALLUMINIO



Articolo	Ø	Lmt	€ Listino	
9771130	3,0	54	10,40	30
9771135	3,3	46	10,40	30
9771140	3,5	41	10,40	24
9771145	4,0	27	10,40	24

Tecno polimero con alluminio. Taglio superiore. Alta tecnologia



FILO QUADRO ARANCIO



Articolo	Ø	Lmt	€ Listino	
9771310	2,4	15	2,82	100
9771315	3,0	15	3,60	100
9771320	3,3	15	3,94	100



FILO QUADRO ARANCIO



Articolo	Ø	Lmt	€ Listino	
9771325	2,4	50	10,62	30
9771330	3,0	50	12,84	24
9771335	3,3	50	14,64	30



FILO TONDO VERDE



Articolo	Ø	Lmt	€ Listino	
9771340	2,4	15	2,64	100
9771345	3,0	15	3,70	100
9771350	3,3	15	4,14	100



FILO TONDO VERDE



Articolo	Ø	Lmt	€ Listino	
9771355	2,4	50	7,32	30
9771360	3,0	50	10,80	30
9771365	3,3	50	10,80	30





BOBINA FILO VERDE



Articolo	Ø	Lmt	Tipo	€ Listino	
9771418	4,0	142	Quadro	36,00	6
9771380	2,4	408	Tondo	36,00	8
9771385	3,0	262	Tondo	36,00	6
9771390	3,3	204	Tondo	36,00	6
9771395	3,5	180	Tondo	36,00	6
9771400	4,0	142	Tondo	36,00	6



BOBINA FILO BLACKPRO 2 KG



Articolo	Ø	Lmt	Tipo	€ Listino	
9771455	3,0	262	Quadro	36,00	8
9771460	3,3	204	Quadro	36,00	8
9771461	4,0	142	Quadro	36,00	8
9771456	5,0	85	Quadro	36,00	8
9771457	6,0	58	Quadro	36,00	8
9771466	3,0	262	Tondo	36,00	8
9771462	3,5	180	Tondo	36,00	6
9771465	4,0	142	Tondo	36,00	6



KIT 100 PEZZI FILO QUADRO SPEZZONI



Articolo	Ø	Lmm	€ Listino	
9771425	3,0	300	6,78	20
9771430	3,3	300	8,70	20
9771435	3,5	300	9,12	20
9771436	4,0	300	9,60	20



FILO SILENZIATO ELICOIDALE



Articolo		€ Listino	
9771123	3,0 x 15 mt	4,14	24
9771125	3,5 x 12 mt	4,25	24
9771127	4,0 x 9 mt	4,25	24

• Un profilo aerodinamico significa meno rumorosità, ma soprattutto meno attrito con l'aria, quindi meno consumo di carburante e massima resa per il decespugliatore. Durata di taglio eccezionale, estremamente performante se usato sulla nostra gamma di testine multifilo.

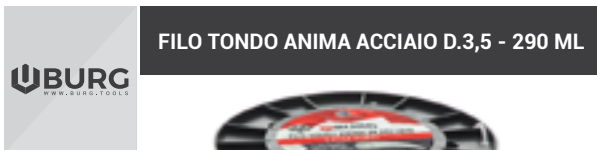

Articolo	Ø	Lmt	Tipo	€ Listino	
9771454	3,5	290	Tondo	200,00	1

• Doppia anima per una resistenza maggiore, all'usura e rottura.



Articolo	Ø	Lmt	Tipo	€ Listino	
9771450	4,0	28	Quadro	13,00	12

• Profilo quadrato per un rendimento superiore alla sezione tonda.
 • Doppia anima per una resistenza maggiore al taglio, all'usura rottura ed abrasione.
 • Elevato punto di fusione.
 • Adatto per l'impiego prolungato.



Articolo	Ø	Lmt	Tipo	€ Listino	
9771445	3,3	41	Quadro	13,00	12

• Profilo quadrato per un rendimento superiore alla sezione tonda.
 • Doppia anima per una resistenza maggiore al taglio, all'usura rottura ed abrasione.
 • Elevato punto di fusione.
 • Adatto per l'impiego prolungato.

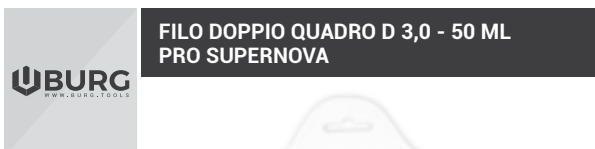

Articolo	Ø	Lmt	Tipo	€ Listino	
9771440	3,0	50	Quadro	13,00	12

• Profilo quadrato per un rendimento superiore alla sezione tonda.
 • Doppia anima per una resistenza maggiore al taglio, all'usura rottura ed abrasione.
 • Elevato punto di fusione.
 • Adatto per l'impiego prolungato.

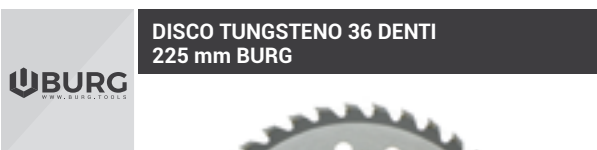

Articolo	€ Listino	
9773797	10,00	12

• Per il taglio di rami, tronchetti e ricrescite. Non per erba.

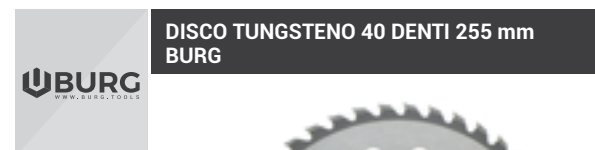

Articolo	€ Listino	
9773799	10,20	12

• Per il taglio di rami, tronchetti e ricrescite. Non per erba.

Per informazioni tecniche, foto e prezzi aggiornati visita il nostro sito www.cillisrl.com



Articolo	Denti	Ø	€ Listino	
9773790	36	225 mm	11,40	12
9773795	40	255 mm	11,70	12

• Per il taglio di rami, tronchetti e ricrescite. Non per erba.



Articolo	Spess.	Ø	€ Listino	
9773615	2,5 mm	250 mm	8,50	24



Articolo	Spess.	Ø	€ Listino	
9773510	2,5 mm	300 mm	8,50	30



Articolo	Lmm	€ Listino	
9772880	310x25,4x3	13,10	10



Articolo	Spess.	Ø	€ Listino	
9773650	2,0 mm	255 mm	5,00	24



Articolo	Spess.	Ø	€ Listino	
9773520	2,5 mm	300 mm	6,20	24
9773530	2,5 mm	250 mm	5,60	24
9773550	1,6 mm	250 mm	4,60	48
9773560	1,6 mm	300 mm	5,10	48



Articolo	Lmm	€ Listino	
9772875	305x25,4x1,6	10,61	12



Articolo	Lmm	€ Listino	
9772885	250x25,4x3	33,60	6

COPPA SOTTODISCO PER DECESPUGLIATORE



Articolo	Ø	€ Listino	
9772008	8 mm	3,20	18
9772010	10 mm	3,20	18

cilli

DISCO ANTI AVVOLGIMENTO UNIVERSALE



Articolo	Lmm	€ Listino	
9772825		4,60	12

• Si usa insieme alla testina per decespugliatore ed impedisce l'avvolgimento dell'erba.

FRESA UNIVERSALE 4 FRESE



Articolo	€ Listino	
9772870	536,00	1

• Fresa universale adatta ad ogni tipo di decespugliatore con asta rigida. Ideale per spazi stretti ed impossibili da raggiungere con utensili a motore quali motozappe e motocoltivatori. Corpo in alluminio, ingranaggi e zappette in acciaio temprato di altissima tenacità! L'unica fresa universale per decespugliatore. Lascia fuori le erbacce dal tuo orto e dal tuo giardino.



SPAZZOLA UNIVERSALE PER ERBACCE



PRO

Articolo	Lmm	€ Listino	
9774153	170	46,00	3
9774155	200	51,00	3

SPELLONATORE UNIVERSALE CON SALVACORTECCIA



PRO

Articolo	Denti	Lmm	€ Listino	
9774170	16	100	122,40	1

Per informazioni tecniche, foto e prezzi aggiornati visita il nostro sito www.cillisrl.com

SPAZZOLA DECESPUGLIATORE PER ERBACCE



Articolo	Lmm	€ Listino	
9774153	170	46,00	3

• Spazzola universale con setole in acciaio adatta a tutti i decespugliatori. Indicata per la pulizia degli interstizi tra gli autobloccanti ed il pavé.

SPOLLONATORE UNIVERSALE



Articolo	Lmm	€ Listino	
9772855	150	137,64	2

• Accessorio universale per taglio polloni con salvacorteccia. Peso: 980gr.

SPOLLONATORE UNIVERSALE



Articolo	Lmm	€ Listino	
9772860	230	126,00	2

• Accessorio universale per taglio polloni con salvacorteccia. Peso: 1414gr.

SPOLLONATORE PRO UNIVERSALE



Articolo	Lmm	€ Listino	
9772850	100	138,00	2

• Accessorio universale per taglio polloni con salvacorteccia. Peso: 650gr.

SPOLLONATORE LIGHT UNIVERSALE

Articolo	Lmm	€ Listino	
9772865	230	95,75	2

• Accessorio universale per taglio polloni con salvacorteccia. Con disco di contrasto inferiore. Peso: 1100gr. Non fornito di coppia conica. Non fornito di asta.



DADO ESAGONALE PER DECESPUGLIATORE FILETTO SINISTRO



Articolo	Ø	Lmm	€ Listino	
9771880	10 mm	1,5	0,70	96
9771890	10 mm	1,25	0,70	96
9771895	8 mm	1,25	0,70	96

BULLONE PER DECESPUGLIATORE FILETTO SINISTRO



Articolo	Tipo	€ Listino	
9771810	M8x1,25xL20mm	0,80	96
9771816	M8x1,25xL25mm	0,80	96
9771820	M10x1,25xL20mm	0,80	96
9771825	M10x1,50xL20mm	0,80	96

PROTEGGI ORTO MODULARE



Articolo	€ Listino	
0653005	2,72	1

• Oltre a proteggere le piante dalla crescita di erbe nocive, questo articolo garantisce una protezione uniforme del suolo dalle escursioni termiche. Questo contribuisce a mantenere il terreno sempre umido riducendo sensibilmente il numero delle innaffiature.

PARASASSI UNIVERSALE



Articolo	Ø	€ Listino	
9772700	26	7,00	12

PARASASSI GRANDE



PRO

Articolo	Ø	€ Listino	
9772730	2624-26-28-32	8,20	12

BRETTA STANDARD PER DECESPUGLIATORE



PRO

Articolo	€ Listino	
9772300	7,10	6

BRETTA PROFESSIONALE PER DECESPUGLIATORE



PRO

Articolo	€ Listino	
9772305	9,80	6

BRETTA DUPLEX CON MOSCHETTONE E SPALLINA



PRO

Articolo	€ Listino	
9772320	15,80	6

GRASSO GRAFITATO A SOFFIETTO PER DECESPUGLIATORE



PRO

Articolo	Kg	€ Listino	
9774200	0,090	4,72	20



**RED-CUT**
139 CC**Rasaerba a trazione con motore a scoppio Burg**

Rasaerba a trazione con larghezza di taglio di 51 cm. Dotato di manico regolabile. Regolazione dell'altezza di taglio tramite 1 leva per 7 diverse posizioni da 25 a 70 mm. Capiente sacco di raccolta in tessuto da 60 L. Ruote anteriori da 180 mm e ruote grandi posteriori da 250 mm
Codice: 9600990



1 leva per 7 diverse posizioni



Capacità sacco raccolta 60 litri



Sistema Mulching



Larghezza di taglio 51 cm



BURG RASAERBA RED-CUT 139 CC



Articolo	€ Listino	
9600990	480,00	1

CARATTERISTICHE	
Modello	RED-CUT 139A
Modello motore	DG1P65F
Cilindrata	139 cm3
Potenza massima	2,6kW/3600 rpm
Trazione	Semovente
Capacità serbatoio benzina	1,5 lt
Volume serbatoio olio	0,6 lt
Larghezza di taglio	510 mm
Velocità nominale	2800 rpm
Pressione sonora	LWA 98 dB(A)
Capacità sacco erba tagliata	60 lt
Altezza regolabile	25-70 mm





Z-173
WWW.BURG.TOOLS



Z-99
WWW.BURG.TOOLS



La gamma di motozappe Burg combina un perfetto equilibrio tra potenza, compattezza e praticità.

Motozappa a scoppio BURG Z-173

Ampiezza di lavoro da 59 cm.
Codice: 9600970

Motozappa a scoppio BURG Z-99

Ampiezza di lavoro da 36 cm.
Codice: 9600975





Articolo	€ Listino	
9600970	500,00	1

CARATTERISTICHE

Motore	4 tempi OHV
Velocità di rotazione max.	3000/min
Cilindrata motore	2,6 Kw / 173 CC
Larghezza di lavoro	590 mm
Diametro fresa	26 cm
Marcia	1
Volume serbatoio carburante	1,5 lt
Volume serbatoio dell'olio lubrificante	0,6 lt
Sistema di avviamento	Avviamento inverso
Livello di potenza sonora	93 dB (A)
Peso Lordo	37,5 Kg





BURG MOTOZAPPA Z-99



Articolo	€ Listino	
9600975	480,00	1

CARATTERISTICHE

Motore	4 tempi OHV
Velocità di rotazione max.	3000/min
Cilindrata motore	1,30 kw / 99 CC
Larghezza di lavoro	360 mm
Diametro fresa	26 cm
Marcia	1
Volume serbatoio carburante	1,5 lt
Volume serbatoio dell'olio lubrificante	0,6 lt
Sistema di avviamento	Avviamento inverso
Livello di potenza sonora	93 dB (A)
Peso Lordo	27 Kg





REDWOOD

2500
CARVING



Articolo	€ Listino	
9804536	200,00	2

CARATTERISTICHE

Modello	Redwood 2500 Carving
Carburatore	Walbro
Cilindrata	25,4 cc
Barra	25 cm /10"
Passo catena	1/4
Spessore	0,050"
Maglie	60
Potenza	0,8 Kw
Regime minimo giri/min	3000 + -300
Regime massimo giri/min	11000
Capacità serbatoio miscela	0,23 lt
Capacità serbatoio olio	0,16 lt
Consumo a 8000 RPM	580 g/Kw.h
Peso netto con barra a catena	3,5 Kg
Dimensioni	265x220x220 cm
Massima larghezza taglio	222 mm
Avviamento	a strappo
Carburante	Miscela
	(benzina + olio sintetico)
Rapporto di miscelazione	2,5%(40:1)

Per informazioni tecniche, foto e prezzi aggiornati visita il nostro sito www.cillisrl.com

BURG
WWW.BURG.TOOLS

MOTOSEGA BURG POTA 12" 25,4 cc. REDWOOD 2500 CARBURATORE WALBRO

REDWOOD 2500



Articolo	€ Listino	
9804525	180,00	2

CARATTERISTICHE

	Redwood 2500
Modello	Redwood 2500
Carburatore	Walbro
Cilindrata	25,4 cc
Barra	30 cm /12"
Passo catena	3/8
Spessore	0,050"
Maglie	44
Potenza	0,8 Kw
Regime minimo giri/min	3000 + -300
Regime massimo giri/min	11000
Capacità serbatoio miscela	0,23 lt
Capacità serbatoio olio	0,16 lt
Consumo a 8000 RPM	580 g/Kw.h
Peso netto con barra a catena	3,7 Kg
Dimensioni	265x220x220 cm
Massima larghezza taglio	222 mm
Avviamento	a strappo
Carburante	Miscela (benzina + olio sintetico)
Rapporto di miscelazione	2,5%(40:1)

BURG
WWW.BURG.TOOLS

MOTOSEGA BURG 18" 45,2 cc. REDWOOD 4500 CARBURATORE WALBRO

REDWOOD 4500



Articolo	€ Listino	
9804700	200,00	2

CARATTERISTICHE

	Redwood 4500
Modello	Redwood 4500
Carburatore	Walbro
Cilindrata	45,2 cc
Barra	45 cm /18"
Passo catena	32,5
Spessore	0,058"
Maglia	72
Potenza	1,7 Kw
Regime minimo giri/min	3000
Regime massimo giri/min	10000
Capacità serbatoio miscela	0,55 lt
Capacità serbatoio olio	0,26 lt
Consumo a 8000 RPM	580 g/Kw.h
Peso netto con barra a catena	6,4 Kg
Dimensioni	410x235x265 cm
Massima larghezza taglio	450 mm
Avviamento	a strappo
Carburante	Miscela (benzina + olio sintetico)
Rapporto di miscelazione	2,5%(40:1)

RICAMBI MOTOSEGHE BURG 9804536 - 9804525

**GRUPPO AVVIAMENTO
BURG 25,4**



Articolo	€ Listino	
9804525R	15,32	1

• Per 9804536-9804525

**GRUPPO FRENO CATENA
BURG 25,4**



Articolo	€ Listino	
9804536C	15,74	1

• Per 9804536-9804525

**CARBURATORE WALBRO
BURG 25,4**





PRO

Articolo	€ Listino	
9804530	38,15	1

• Per 9804536-9804525

**CARBURATORE MOTOSEGA
BURG 25,4**



Articolo	€ Listino	
9804525G	19,71	1

• Per 9804536-9804525

**CILINDRO + INNESTO
BURG 25,4**



Articolo	€ Listino	
9804536A	23,02	1

• Per 9804536-9804525

**ALBERO MOTORE
BURG 25,4**



Articolo	€ Listino	
9804536H	16,00	1

• Per 9804536-9804525

**GRUPPO VOLANO
BURG 25,4**



Articolo	€ Listino	
9804536R	10,68	1

• Per 9804536-9804525

**VITE PER POMPA OLIO
BURG 25,4**



Articolo	€ Listino	
98045365	0,40	1

• Per 9804536-9804525



Per informazioni tecniche, foto e prezzi aggiornati visita il nostro sito www.cillisrl.com



Articolo	€ Listino	
98045251	1,72	1

• Per 9804536-9804525



Articolo	€ Listino	
98045251	1,23	1

• Per 9804536-9804525



Articolo	€ Listino	
9804536P	0,76	1

• Per 9804536-9804525



Articolo	€ Listino	
9804525D	1,26	1

• Per 9804536-9804525



Articolo	€ Listino	
9804525F	0,60	1

• Per 9804536-9804525



Articolo	€ Listino	
9804525O	1,20	1

• Per 9804536-9804525



Articolo	€ Listino	
9804525L	1,20	1

• Per 9804536-9804525

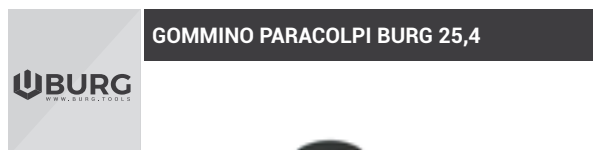

Articolo	€ Listino	
9804525M	1,46	1

• Per 9804536-9804525

GABBIA A RULLI FRIZIONE BURG 25,4



Articolo	€ Listino	
9804525C	2,66	1

• Per 9804536-9804525

LEVETTA ARIA BURG 25,4



Articolo	€ Listino	
9804525E	0,76	1

• Per 9804536-9804525

INTERRUTTORE ON-OFF BURG 25,4



Articolo	€ Listino	
9804536W	2,36	1

• Per 9804536-9804525

CONNETTORE TUBO BURG 25,4



Articolo	€ Listino	
9804536I	0,76	1

• Per 9804536-9804525

TUBICINO CARBURANTE BURG 25,4



Articolo	€ Listino	
9804536Z	1,00	1

• Per 9804536-9804525

PRIMER PESCAGGIO BURG 25,4



Articolo	€ Listino	
9804536K	6,28	1

• Per 9804536-9804525

TUBO BENZINA BURG 25,4



Articolo	€ Listino	
9804536D	0,76	1

• Per 9804536-9804525

FILTRO OLIO BURG 25,4



Articolo	€ Listino	
98045363	2,00	1

• Per 9804536-9804525



Per informazioni tecniche, foto e prezzi aggiornati visita il nostro sito www.cillisrl.com

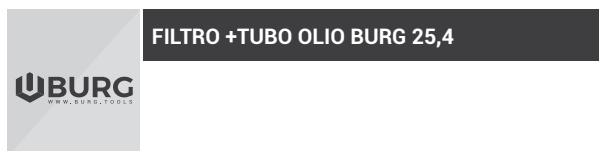

Articolo	€ Listino	
9804536J	4,76	1

• Per 9804536-9804525

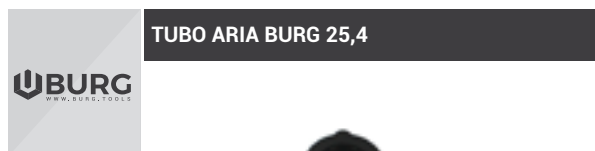

Articolo	€ Listino	
9804536N	1,76	1

• Per 9804536-9804525

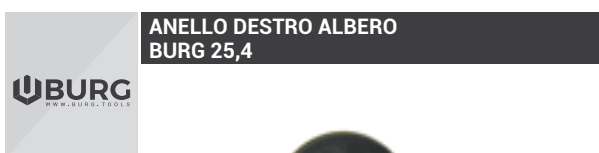

Articolo	€ Listino	
9804536M	2,40	1

• Per 9804536-9804525



Articolo	€ Listino	
9804536S	0,66	1

• Per 9804536-9804525



Articolo	€ Listino	
9804536G	1,26	1

• Per 9804536-9804525

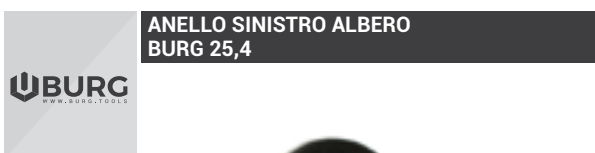

Articolo	€ Listino	
9804536L	2,26	1

• Per 9804536-9804525



Articolo	€ Listino	
9804536I	2,86	1

• Per 9804536-9804525

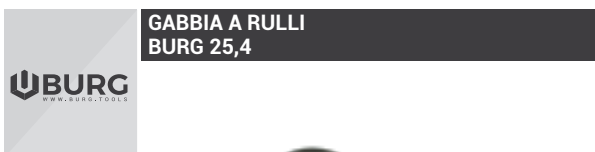

Articolo	€ Listino	
9804536F	2,86	1

• Per 9804536-9804525

TUBICINO OLIO CATENA
BURG 25,4



Articolo	€ Listino	
98045362	1,00	1

• Per 9804536-9804525

VITE BLOCCAGGIO BOBINA
BURG 25,4





Articolo	€ Listino	
9804536U	0,36	1

• Per 9804536-9804525

CANDELA MOTOSEGA
BURG 25,4





Articolo	€ Listino	
9804536V	2,80	1

• Per 9804536-9804525

MARMITTA MOTOSEGA
BURG 25,4





Articolo	€ Listino	
9804536O	5,82	1

• Per 9804536-9804525

TAMBURO FRIZIONE PIGNONE
BURG 25,4





Articolo	€ Listino	
9804525T	7,14	1

• Per 9804536-9804525

PISTONE SPINOTTO FERMO FASCIA
BURG 25,4



Articolo	€ Listino	
9804536B	9,26	1

• Per 9804536-9804525

TAPPO BENZINA
BURG 25,4





Articolo	€ Listino	
9804536X	1,76	1

• Per 9804536-9804525

GUARNIZIONE POMPA
BURG 25,4



Articolo	€ Listino	
98045366	0,96	1

• Per 9804536-9804525

Per informazioni tecniche, foto e prezzi aggiornati visita il nostro sito www.cillisrl.com

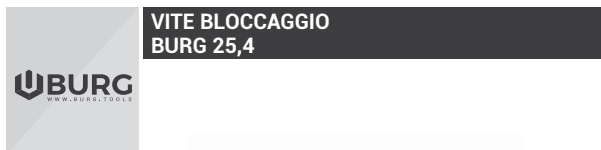

**VITE BLOCCAGGIO
BURG 25,4**



Articolo	€ Listino	
9804536Q	0,76	1

• Per 9804536-9804525

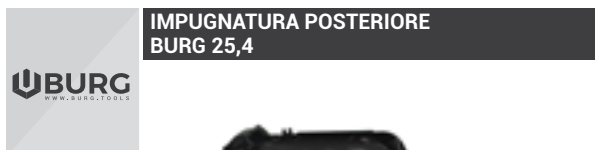

**IMPUGNATURA POSTERIORE
BURG 25,4**



Articolo	€ Listino	
9804525N	6,16	1

• Per 9804536-9804525



**PASSACAVO OLIO
BURG 25,4**



Articolo	€ Listino	
98045367	0,80	1

• Per 9804536-9804525

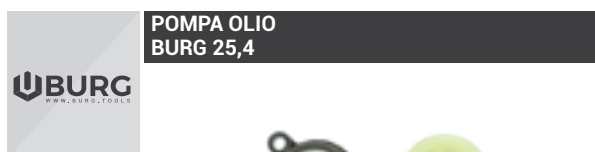

**POMPA OLIO
BURG 25,4**



Articolo	€ Listino	
98045364	7,52	1

• Per 9804536-9804525



**SUPPORTI VALVOLA E CILINDRO
BURG 25,4**



Articolo	€ Listino	
9804536E	3,56	1

• Per 9804536-9804525

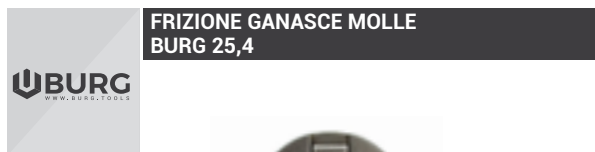

**FRIZIONE GANASCE MOLLE
BURG 25,4**



Articolo	€ Listino	
9804525S	4,36	1

• Per 9804536-9804525

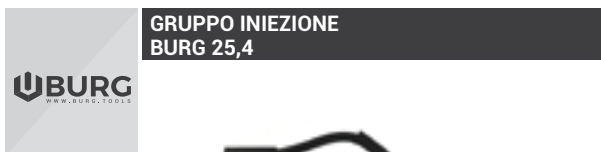

**GRUPPO INIEZIONE
BURG 25,4**



Articolo	€ Listino	
9804536T	12,14	1

• Per 9804536-9804525



**FILTRO ARIA
BURG 25,4**



Articolo	€ Listino	
9804525H	4,20	1

• Per 9804536-9804525

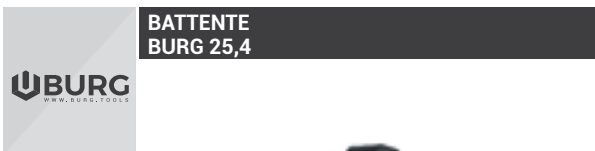

Articolo	€ Listino	
9804536Y	1,56	1

• Per 9804536-9804525

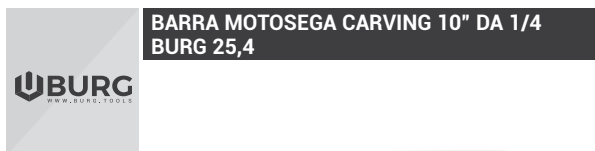

Articolo	Lcm	€ Listino	
98045369	25	22,00	1

• Per 9804536-9804525



Articolo	Lcm	€ Listino	
9804525P	30	9,64	1

• Per 9804536-9804525



Articolo	Lcm	€ Listino	
9804525Q	30	8,20	1

• Per 9804525



Articolo	Lcm	€ Listino	
98045368	25	8,80	1

• Per 9804536



RICAMBI MOTOSEGHE BURG 9804700



**ALLOGGIO AVVIAMENTO
BURG 45,2**



Articolo	€ Listino	
9804700L	4,62	1

• Per 9804700

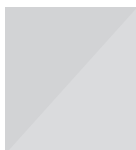

**CARBURATORE WALBRO
BURG 45,2**



Articolo	€ Listino	
9804532	38,15	1

• Carburatore originale Walbro. Per 9804700



**CILINDRO
BURG 45,2**



Articolo	€ Listino	
9804700X	19,36	1

• Per 9804700



**COVER VITI SPUGNETTA
BURG 45,2**



Articolo	€ Listino	
9804700U	2,40	1

• Per 9804700



**FLANGIA TERMICA
BURG 45,2**



Articolo	€ Listino	
9804700B	1,80	1

• Per 9804700



**GUARNIZIONE CILINDRO
BURG 45,2**



Articolo	€ Listino	
9804700E	0,96	1

• Per 9804700



**IMPUGNATURA AVVIAMENTO
BURG 45,2**



Articolo	€ Listino	
9804700R	2,80	1

• Per 9804700



**GOMMINO PER AVVIAMENTO
BURG 45,2**



Articolo	€ Listino	
9804700M	1,00	1

• Per 9804700

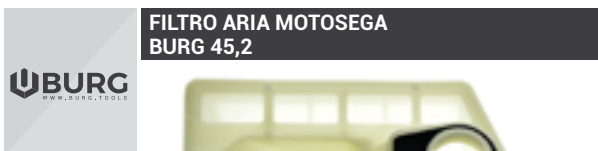

Articolo	€ Listino	
98047002	2,75	1

• Per 9804700



Articolo	€ Listino	
9804700S	0,39	1

• Per 9804700

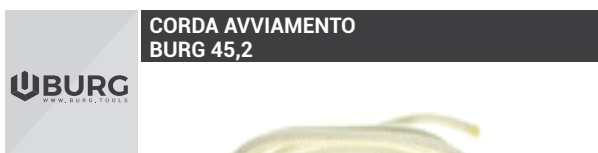

Articolo	€ Listino	
9804700Q	1,46	1

• Per 9804700



Articolo	€ Listino	
9804700J	12,14	1

• Per 9804700

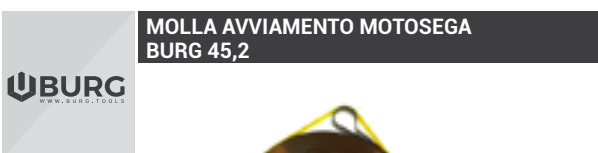

Articolo	€ Listino	
98047000	4,20	1

• Per 9804700



Articolo	€ Listino	
9804700P	1,00	1

• Per 9804700



Articolo	€ Listino	
9804700Y	7,54	1

• Per 9804700



Articolo	€ Listino	
9804700W	12,96	1

• Per 9804700



Per informazioni tecniche, foto e prezzi aggiornati visita il nostro sito www.cillisrl.com



Articolo	€ Listino	
9804700V	7,70	1

• Per 9804700



Articolo	€ Listino	
9804700A	0,50	1

• Per 9804700

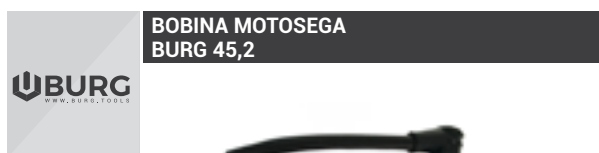

Articolo	€ Listino	
9804700K	13,56	1

• Per 9804700



Articolo	€ Listino	
9804700I	7,92	1

• Per 9804700

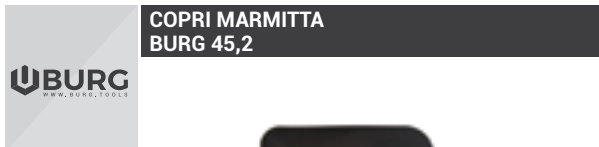

Articolo	€ Listino	
9804700H	1,80	1

• Per 9804700



Articolo	€ Listino	
9804700F	7,70	1

• Per 9804700



Articolo	€ Listino	
9804700C	0,60	1

• Per 9804700



Articolo	€ Listino	
9804700T	1,80	1

• Per 9804700

**GUARNIZIONE MARMITTA
BURG 45,2**



Articolo	€ Listino	
9804700G	1,00	1

• Per 9804700

**SUPPORTO CARBURATORE
BURG 45,2**



Articolo	€ Listino	
9804700D	4,06	1

• Per 9804700

**AVVIAMENTO
BURG 45,2**



Articolo	€ Listino	
9804700N	2,36	1

• Per 9804700

**BARRA 18" MOTOSEGA
BURG 45,2**



Articolo	€ Listino	
9804700Z	13,80	1

• Per 9804700

**CATENA 18" MOTOSEGA
BURG 45,2**



Articolo	€ Listino	
98047001	12,26	1

• Per 9804700



Per informazioni tecniche, foto e prezzi aggiornati visita il nostro sito www.cillisrl.com

BARRA CARVING 8" STELLITE LUCIDA



PRO

Articolo	Passo	€ Listino	
9753055	050"	89,32	5

BARRA CARVING 10" STELLITE VERNICIATA



PRO

Articolo	Passo	Lmm	€ Listino	
9753060	1/4"	250	77,00	5

BARRA FORESTAL AGRICOLA 8"



PRO

Articolo	Passo	Lmm	€ Listino	
9753070	1/4"	200	24,70	5

BARRA MOTOSEGA POTATURA



PRO

Articolo	Passo	€ Listino	
9752182	3/8"	17,30	5
9752184	3/8"	17,25	5
9752186	3/8LP"	17,25	5
9752188	3/8"	17,25	5
9752190	.325"	17,25	5
9752192	.325"	17,25	5

Attacco 1



Attacco 5



Attacco 7



Codice	lunghezza cm	lunghezza pollici	passo	descrizione	attacco
9752180	25	10"	1/4"	barra carving 10" (60 maglie) per THC	7
9752182	25	10"	3/8"	barra 10" (40 maglie) per TH	1
9752184	30	12"	3/8"	barra 12" (44 maglie) per TH	1

Codice	lunghezza cm	lunghezza pollici	passo	spessore mm	spessore pollici	n° maglie	attacco
9752186	35	14"	3/8 LP	1,3	.050"	52	1
9752188	40	16"	3/8 LP	1,3	.050"	57	1
9752190	45	18"	.325"	1,5	.058"	72	5
9752192	40	16"	.325"	1,5	.058"	66	5

BARRA OREGON 8"



PRO

Articolo	€ Listino	
9753000	24,70	5

BARRA LUBRI TEC OREGON 3/8"



PRO

Articolo	Maglie	€ Listino	
9753010	40	24,70	5

Codice	Lunghezza cm	Lunghezza pollici	Passo	Spessore mm	Spessore pollici	N°maglie	Denti rochetto	Adatti alle motoseghe
9753010	25	10"	3/8 Low profile	1,3	.050"	40	7T	Black+Decker, Crastsmen, Echo, Poulan, Maruyama.
9753060	25	10"	1/4	1,3	.050"	60	---	---
9753000	20	8"						

BARRA OREGON DOUBLE GUARD



PRO

Articolo	Passo	Cod. Oregon	€ Listino	
9751800	8"	080SDEA041	20,50	2
9751805	10"	100SDEA041	21,00	2
9751810	12"	120SDEA041	21,70	2
9751815	14"	140SDEA041	22,00	2
9751820	16"	160SDEA041	24,80	2
9751825	18"	188PXBK095	31,08	2

BARRA OREGON ADVANCE CUT



PRO

Articolo	Passo	Cod. Oregon	€ Listino	
9751830	20"	208PXBK095	32,68	2



Per informazioni tecniche, foto e prezzi aggiornati visita il nostro sito www.cillisrl.com



ROTOLO CATENA PROFESSIONALE 100 PIEDI



PRO

Articolo	Lmt	€ Listino	
9750100	3/8	30	386,00
9750110	3/8	30	386,00
9750120	325	30	504,00
9750130	325	30	504,00
9750140	325	30	350,00



ROTOLO CATENA PROFESSIONALE 100 PIEDI



PRO

Articolo	Passo	Lmm	€ Listino
9750180	3/8"	1,3	499,00

• Tondo A1EP-1640E

Codice	Tipo	Rif. Windsor	Rif. Oregon	Passo	Spessore maglia		Lunghezza rolo		N° maglie
					Pollici	mm	Piedi	Metri	
9750100/MINI	LO-PRO	50R	91VS	3/8	0.50	1.3	100R	30.5	1640
9750110/MINI	LO-PRO	50RG	91VG	3/8	0.50	1.3	100R	30.5	1640
9750120/TONDO	SE-	50J	20BP	325	0.50	1.3	100R	30.5	1848
9750130/TONDO	ULTRA-LINK	58J	21BP	325	0.58	1.5	100R	30.5	1848
9750140/TONDO	ULTRA-LINK	63J	22BP	325	0.63	1.6	100R	30.5	1848



ROTOLO CATENA PROFESSIONALE 25 PIEDI



PRO

Articolo	Passo	Lmm	€ Listino
9750090	1/4".050"	1,3	185,60

• Tipo catena Micro-Chisel/Bumperlink



ROTOLO CATENA PROFESSIONALE 25 PIEDI



PRO

Articolo	Passo	€ Listino
9750900	3/8".043"	130,00

• Tipo catena Semi-Chisel/Bumperlink Narrow Kerf



CATENA MOTOSEGA CF



PRO

Articolo	Denti	Maglie	Cod.Oregon	€ Listino
9751700	1/4 .050"/1,3mm	48	24AP048E	17,22
9751705	1/4 .050"/1,3mm	52	25AP052E	18,68
9751710	1/4 .050"/1,3mm	60	25AP060E	22,32

• Tipo catena Micro-Chisel Tondino adatto 5/32" 4.0mm



CATENA MOTOSEGA CF



PRO

Articolo	Denti	Maglie	Cod.Oregon	€ Listino
9751715	3/8.050"/1,3mm	40	91P040E	11,88
9751720	3/8.050"/1,3mm	45	91P045E	13,36
9751725	3/8.050"/1,3mm	52	91P052E	15,44

• Tipo catena Chamfer-Chisel Tondino adatto 5/32" 4.0mm



CATENA MOTOSEGA



PRO

Articolo		€ Listino	
9751900	8" 91PJ033X	12,50	6
9751905	10" 91PJ040X	12,60	6
9751910	12" 91PJ045X	15,26	6
9751915	14" 91PJ052X	18,54	6
9751920	16" 91P057X	20,00	6
9751925	18" 21LPX072X	29,20	6
9751930	20" 21LPX076X	29,40	6

CATENA MOTOSEGA



Articolo		Lcm	€ Listino	
9751408	3/8"LP 050/1,3mm 40M	25	8,16	1
9751410	3/8"LP 050/1,3mm 45E	30	9,15	1
9751412	3/8"LP 050/1,3mm 50E	35	10,90	1
9751414	3/8"LP 050/1,3mm 52E	35	11,10	1
9751416	3/8"LP 050/1,3mm 56M	40	11,40	1
9751418	3/8"LP 050/1,3mm 57E	40	11,80	1
9751420	325" 050/1,3mm 64	38	13,00	1
9751422	325" 050/1,3mm 72	45	15,30	1
9751424	325" 058/1,5mm 72E	45	15,30	1
9751426	1/4" 050/1,3mm 60M	25	14,30	1

Carving

IMBUTITORE MANUALE DA BANCO



PRO

Articolo	€ Listino	
9752400	61,30	1

• Indonea per rivettare tutti i tipi di catena.

**AFFILACATENA DA BANCO
PRODOTTO PROFESSIONALE**

Articolo	Tipo	€ Listino	
9780025	230V-50Hz 90W	46,00	1
9780035	Mola 108x3,2xdi.23mm	5,00	12

• Mola in dotazione

ROTOLO CATENA



Articolo	Passo	Lmt	€ Listino	
9751400	3/8" 050/1,3mm	30	262,50	1
9751402	325" 050/1,3mm	30	325,00	1
9751404	325" 058/1,5mm	30	325,00	1
9751406	3/8" 058/1,5mm	30	308,00	1

MAGLIA CATENA 1/4"

• Tipo catena 50K



Articolo		€ Listino	
9750902	Con rivetto A	0,90	50
9750904	Senza rivetto B	0,72	50

MAGLIA CATENA 325"

• Tipo catena 50J - 58J



Articolo		€ Listino	
9750115	Con rivetto 325 Pas 1,3	0,90	50

ROMPICATENA MANUALE DA BANCO



PRO

Articolo	€ Listino	
9752410	74,00	1



Per informazioni tecniche, foto e prezzi aggiornati visita il nostro sito www.cillisrl.com

AFFILACATENA ELETTRICA FRANZ PROFESSIONALE



Articolo	Tipo	€ Listino	
9780032	230V-50Hz 200W	222,50	1

• Può affilare correttamente entrambi i denti della catena senza invertire il moto della mola.

MOLA PER AFFILACATENA CON FORO 22



Articolo	Lmm	€ Listino	
9780060	145x22x3	16,88	4
9780065	145x22x4,5	22,60	4
9780070	145x22x6	28,26	4

• Mola ricambio per affilacatena Franz

LIMA PIATTA PER CATENA MOTOSEGA



Articolo	Tipo	€ Listino	
9781245	6"	4,42	24

SET 3 SPAZZOLINI PER CANDELE



Articolo	€ Listino	
9875003	1,64	60

TONDINO PROFESSIONALE ORIGINALE OBERG



Articolo	Tipo	Ø	Lmm	€ Listino	
9781190	1/4"	3,2	6"	1,34	120
9781200	5/32"	4,0	8"	1,34	120
9781206	.325"	4,5	8"	1,34	120
9781210	3/16"	4,8	8"	1,34	120
9781220	13/64"	5,2	8"	1,34	120
9781230	7/32"	5,5	8"	1,34	120
9781233	1/2"	6,3	8"	1,34	120

CANDELE TORCH



PRO

Articolo	Adattabili			€ Listino		
9782600	F6TC	21	Lungo	BP6ES	1,34	30
9782603	DJ8J	16	Corto	BM6F	1,34	30
9782606	L6C	19	Corto	BM6A	1,34	30
9782609	GL4C	21	Corto	B4LM	1,34	30
9782612	E6C	21	Normale	B6HS	1,34	30
9782615	L7TC	19	Corto	BPM7A	1,34	30
9782618	L6TC	19	Corto	BPM6A	1,34	30
9782621	L7C	19	Corto	BM7A	1,34	30

OLIO MOTORE SINTETICO 10W/40 - 1LT



Articolo	Lt	€ Listino	
9799918	1	9,00	12

FUSTO 20LT OLIO MOTORE SINTETICO 100W/40



Articolo	Lt	€ Listino	
9799919	20	156,00	1

PROTETTIVO CATENE ECOFIL

- Elevata biodegradabilità (superiore 90%)



Articolo	Lt	€ Listino	
9799900	5	19,00	4

PROTETTIVO CATENE TANICA 5LT



Articolo	Lt	€ Listino	
9799902	5	16,00	12

OLIO 2 TEMPI MIX BASE SINTETICA

- Lubrificante a base sintetica automiscelante di colore verde per motori a 2 tempi a miscela o a lubrificazione separata, dotati di raffreddamento ad aria o ad acqua.



Articolo	Lt	€ Listino	
9799920	1	7,70	12

OLIO 2 TEMPI MIX 100% SINTETICO 50:1

- Wik 2T super agro ha superato le più severe prove di controllo, per cui assicura una completa protezione del motore contro la corrosione, la ruggine, l'usura ed il grippaggio.



Articolo	Lt	€ Listino	
9799800	1	8,40	12

OLIO MOTORE 7+ 15W/40 MULTIGRADO

- Motor oil, lubrificante qualitativamente superiore, indicato per motori, alimentati con ogni tipo di carburante.



Articolo	Lt	€ Listino	
9799809	1	6,40	12

PROTETTIVO CATENE TANICA 1LT



Articolo	Lt	€ Listino	
9799907	1	4,30	40

OLIO MOTORE 4 TEMPI BASE SINTETICA SAE 10W/40

- Lubrificante qualitativamente superiore, indicato per motori aspiranti, turbocompressori, multivalvole, alimentati con ogni tipo di carburante.



Articolo	Lt	€ Listino	
9799915	1	6,98	12

BOX DA 50 PZ MIX BASE SINTETICA

- Olio con base sintetica per motori a due tempi operanti ad altissimo numero di giri.



Articolo	Ml	€ Listino	
9799910	100	72,00	1

OLIO 2 TEMPI MIX 100% SINTETICO CON DOSATORE 50:1

- Wik 2T super agro ha superato le più severe prove di controllo, per cui assicura una completa protezione del motore contro la corrosione, la ruggine, l'usura ed il grippaggio.



Articolo	Lt	€ Listino	
9799803	1	9,80	12

OLIO 4 TEMPI MOTORI PER RASAERBA E MACCHINE AGRICOLE

- Lubrificante specifico per motori a quattro tempi di rasaerba e macchine da giardinaggio di ogni tipo e potenza con alimentazione a benzina o gasolio.



Articolo	Ml	€ Listino	
9799812	600	5,04	12

Per informazioni tecniche, foto e prezzi aggiornati visita il nostro sito www.cillisrl.com

GRASSO A BASE SAPONI DI CALCIO 800 G

• Wik Tkc 2, grasso con base di saponi di calcio per la lubrificazione generale di macchinario operante in condizioni medie di esercizio.



Articolo	Kg	€ Listino	
9799806	0,800	7,78	12

GIROFARO MAGNETICO



Articolo	Tipo	€ Listino	
9740200	12 Volt Con lampadina	40,80	1
9740205	12-24 Volt Senza lampadina	46,24	1

• Omologazione R10-04 13008

LAMPEGGIANTE A LED FLESSIBILE ATENA



Articolo	Tipo	Lmm	€ Listino	
9740202	12-24 Volt	209x127	72,14	1

• Certificazioni: CE, EMC, ECE, R65

LAMPADA AUTOMOTIVA PER GIROFARO



Articolo	Tipo	€ Listino	
9740210	12V-55W	1,77	1
9740212	24V-70W	1,88	1

FARO DA LAVORO LED TONDO



Articolo	Lmm	€ Listino	
9740250	110x128	24,21	1

FARO DA LAVORO LED QUADRO



Articolo	Lmm	€ Listino	
9740255	110x128	26,93	1

FANALE ANTERIORE A DUE LUCI PER TRATTORI



Articolo	Tipo	€ Listino	
9740220	DX	51,68	1
9740225	SX	51,68	1

• Abbagliante, anabbagliante, luce di posizione.

LAMPADA PER FANALE ANTERIORE



Articolo	Tipo	€ Listino	
9740226	12V-45/40W S2	2,15	1
9740228	12V-3W BA9S	0,33	1

FANALE POSTERIORE



Articolo	Tipo	€ Listino	
9740230	DX 108x103mm	3,81	1
9740235	SX 108x103mm	3,81	1

• Lampadine non incluse

LAMPADA PER FANALE POSTERIORE



Articolo	Tipo	€ Listino	
9740236	12V-21W P21W BA15S	0,58	1
9740238	12V-5W C5W SV 8.5-8	0,39	1

SEDILE CON MOLLEGGIO VERTICALE 2 PUNTI+STAFFA



• Corsa sospensione: 70mm
 Regolazione peso: 50-120
 Regolazione longitudinale: 105mm
 Colore: nero
 Base: orizzontale
 Omologazione: CEE78/764
 Classe A I-II
 Note: adatto a trattori fino a 80CV
 Conformità: ISO3776-2

Articolo	€ Listino	
9740300	244,54	1

SEDILE PER CARRELLI ELEVATORI E MACCHINE SPECIALI



• CON MOLLE INCORPORATE
 Corsa sospensione: 50mm
 Regolazione peso: 50-120
 Regolazione longitudinale: 150mm
 Regolazione schienale: 0°-15°
 Modello: Microswitch incorporato
 Note: Sedile per carrelli elevatori, cingolati, miniescavatori

Articolo	€ Listino	
9740310	160,48	1

ALBERO CARDANICO CON DISPOSITIVO DI SICUREZZA



PRO

Articolo	Dimensioni	€ Listino	
9740133	4x1000	223,04	1
9740100	4x1000	258,40	1
9740022	5x700	150,00	1
9740130	6x1000	269,28	1
9740109	6x1000	299,20	1
9740103	6x1000	342,72	1
9740032	6x1500	197,50	1
9740106	6x800	285,60	1

Per informazioni tecniche, foto e prezzi aggiornati visita il nostro sito www.cillisrl.com

ALBERO CARDANICO



PRO 

Articolo	Dimensioni	€ Listino	
9740003	1x800	107,50	1
9740006	1x1000	110,00	1
9740009	2x800	120,00	1
9740012	2x1000	125,00	1
9740015	Cat 4x800	127,50	1
9740018	Cat 4x1000	135,00	1
9740023	5x600	133,00	1
9740021	5x800	150,00	1
9740024	5x1000	162,50	1
9740027	6x1000	180,00	1
9740030	6x1200	187,50	1

BRACCIO TERZO PUNTO TOP



PRO 

Articolo	Dimensioni	€ Listino	
9740170	30x3 470-720	64,00	1
9740175	27x3 460-690	60,00	1
9740180	36x3 640-860	112,00	1
9740185	27x3 585-810	67,00	1
9740190	36x3 615-900	116,00	1

CODICE	CATEGORIA	TIPO	POTENZA		L MM
			TRASMISSIONE 540GIRI	TRASMISSIONE 540GIRI	
9740003	1	c-tubo triangolare spinato	16CV-HP	25CV-HP	800
9740006	1	c-tubo triangolare spinato	16CV-HP	25CV-HP	1000
9740009	2	c-tubo triangolare spinato	21CV-HP	31CV-HP	800
9740012	2	c-tubo triangolare spinato	21CV-HP	31CV-HP	1000
9740015	4	c-tubo triangolare spinato	35CV-HP	55CV-HP	800
9740018	4	c-tubo triangolare spinato	35CV-HP	55CV-HP	1000
9740023	5	c-tubo triangolare spinato	47CV-HP	74CV-HP	600
9740021	5	c-tubo triangolare spinato	47CV-HP	74CV-HP	800
9740024	5	c-tubo triangolare spinato	47CV-HP	74CV-HP	1000
9740027	6	c-tubo triangolare spinato	64CV-HP	100CV-HP	1000
9740030	6	c-tubo triangolare spinato	64CV-HP	100CV-HP	1200

KIT ATTACCO ATTREZZO PARTE INDFERIORE



Articolo	€ Listino	
9740195	273,00	1

DADO M22 X 1,5 X PUNTE ROTOBALLE SVASATO



Articolo	€ Listino	
9740035	1,50	1

BUSSOLA SUPPORTO PUNTE D.36MM



Articolo	€ Listino	
9740034	15,00	1



IRRIGAZIONE





CENTRALINA A BATTERIA 14 PROGRAMMI 1 USCITA 3/4"

Centralina per irrigazione dotata di due manopole :
- manopola frequenza per regolare l'intervallo d'innaffio da un ora ad una settimana;
- manopola durata, per regolare la durata dell'irrigazione da un minuto a 120 minuti, con la possibilità di accensione continua.
Funziona con 2 batterie ministilo, non in dotazione.



Articolo	€ Listino	
9216020	26,00	6



CENTRALINA A BATTERIA DI COMANDO 1 BACCARA

Articolo		€ Listino	
9160620		68,50	10
9160622	Membrana	8,50	5
9160624	Solenioide Baccarà	16,80	5



9160622



9160624

CENTRALINA ORBIT POCKET



Articolo	Stazioni	€ Listino	
9160290	4	58,24	6
9160295	6	66,32	6

CARATTERISTICHE:

- Tempi di irrigazione da 1 a 99 minuti per stazione con 1 minuto di incremento
- Due programmi A, B
- Quattro partenze giornaliere per programma
- Funzione manuale e semiautomatica
- Programma soccorso
- Calendario settimanale o intervalli di 48 ore o da 1 a 28 giorni
- Ogni stazione può essere assegnata ad uno o a tutti e due i programmi disponibili (A e B)
- Possibilità di ritardare o interrompere il ciclo irriguo di 24 ore
- Tasto RAIN DELAY per ritardare o interrompere il ciclo irriguo da 24 a 72 ore.

CENTRALINA CON TRASFORMATORE ESTERNO



Articolo	Stazioni	€ Listino	
9160210	4	55,00	3
9160220	6	64,00	3

Ogni settore può essere programmato in modo completamente indipendente dall'altro: l'irrigazione avverrà in sequenza dal 1° settore all'orario prescelto e, rispettando i diversi tempi impostati, proseguirà fino a completare il ciclo di irrigazione.

Ideali per l'irrigazione residenziale e a goccia, queste centraline sono state costruite combinando la tecnologia elettronica con quella meccanica e risultano quindi molto semplici da programmare e versatili nell'utilizzo. Ruotando il selettore "OFF" è possibile no effettuare l'irrigazione nei giorni di pioggia senza che il programma precedentemente memorizzato si annulli.

Le centraline WM possiedono una batteria tampone per il mantenimento del programma in mancanza di corrente, come pure un'apposita uscita per il comando pompa.

- Tempi di irrigazione da un minimo di 2 minuti ad un massimo di 120 minuti per settore
- Cicli di irrigazione, da un minimo di una volta ogni 14 giorni, ad un massimo di 8 volte al giorno
- Triplo programma con possibilità di differenziare i giorni di irrigazione per ogni settore
- Trasformatore interno a bassa tensione 24 V conforme alle norme
- Trasformatore esterno a bassa tensione 24 V conforme alle norme

CENTRALINA 1 SETTORE AMICO +



Articolo	€ Listino	
9160167	53,90	1

CENTRALINA 2 SETTORE AMICO +2



Articolo	€ Listino	
9160168	76,40	1

CENTRALINA A BATTERIA PER POZZETTO 1" F CON ELETTROVALVOLA

CARATTERISTICHE TECNICHE

- Numero settori 1.
- Alimentata con 2 batterie alcaline 1.5 v olt (AA)
- Materiale di fabbricazione ABS
- Coperchio di chiusura
- Alloggiamento batterie con OR di tenuta.
- Schermo retroilluminato
- Comanda solenoidi bistabili
- Tenuta stagna (IP68)
- Cavo rosso per il collegamento sensore pioggia due fili meccanico
- Staffa centralina per pozzetti

Articolo	€ Listino	
9160170	68,00	2



CENTRALINA C-DIAL 24VAC

CARATTERISTICHE TECNICHE

- Modello INDOOR con trasformatore esterno
- Outputs 24 Volts AC, 0,8 AMP
- Batterie tampone 2x1.5 volt AA alkaline (non include)
- Ingresso sensore pioggia
- Comando pompa e Master Valve (24 VAC out)
- Modello per interni
- Sportello protettivo
- Tasto reset
- Tasto clear
- Dimensioni: 15 x 4,3 x 14 cm

Articolo	Stazioni	€ Listino	
9160135	4	55,76	3
9160140	6	58,00	3



CENTRALINA I-DIAL 24VAC INDOR

CARATTERISTICHE TECNICHE

- Modello INDOOR con trasformatore esterno
- Alimentazione 220 VAC 50Hz
- Outputs 24 Volts AC, 0,8 AMP
- Batterie tampone 2 x 1.5 v olt AA alkaline (non include)
- Schermo retroilluminato
- Uscita comando pompa e Master V alve (24 VAC out)
- Ingresso sensore pioggia
- Dimensioni: 15 x 4,5 x 15,3 cm

Articolo	Stazioni	€ Listino	
9160150	6	81,40	3



Per informazioni tecniche, foto e prezzi aggiornati visita il nostro sito www.cillisrl.com

CENTRALINA I-DIAL 4 STAZIONI 24VAC OUTDOOR

CARATTERISTICHE TECNICHE

- Modello OUTDOOR (IP 43) con trasformatore interno
- Alimentazione 220 VAC 50Hz
- Outputs 24 Volts AC, 1.0 AMP
- Batterie tampone 2 x 1.5 v olt AA alkaline (non incluse)
- Schermo retroilluminato
- Uscita comando pompa e Ma ster Valve (24 VAC out)
- Ingresso sensore pioggia
- Dimensioni: 17 x 11 x 22 cm

Articolo	Stazioni	€ Listino	
9160155	4	117,00	2
9160160	6	129,00	2
9160165	8	162,00	2



CENTRALINA ORBIT CON TRASFORMATORE INTERNO

Articolo	Stazioni	€ Listino	
9160215	4	162,15	3
9160225	6	197,55	3
9160235	9	233,80	1
9160240	12	307,40	1



TRASFORMATORE ORBIT HRC 050



Articolo	€ Listino	
9160205	24,72	6

SENSORE PIOGGIA PER CENTRALINE



Articolo	€ Listino	
9160172	28,00	1

• Sensore pioggia installabile su tutti i tipi di centralina. Regolabile in funzione del volume di precipitazione da un minimo di 3mm. Ad un massimo di 250 mm. Tre possibilità di installazione: su grondaia, ad innesto e filettato.

Dimensioni: Larghezza 9 cm, altezza 11 cm.

REGOLATORE DI PRESSIONE ABS F-M



Articolo	Bar	€ Listino	
1012110	1,1	6,40	12
1012115	1,4	6,40	12

**ELETTROVALVOLA CON
REGOLATORE DI FLUSSO**



Articolo		€ Listino	
9160550	2"	63,76	4

**ELETTROVALVOLA NYLON 24V
CON REGOLATORE DI FLUSSO**



Articolo		€ Listino	
9160530	1 - 1/2"	39,30	4

ELETTROVALVOLA FC-24V



Articolo		€ Listino	
9160180	1" F	14,42	12

Materiale: PA 6 30% Fibra vetro.
 Membrana in parti co-stampata per una miglior tenuta in chiusura.
 Astina in acciaio autopulente.
 Molla della membrana in acciaio con azione progressiva.
 Apertura manuale sotto al solenoide.
 Parzializzatore opzionale.
 Solenoide certificato CE, IP 68 9.
 Solenoide standard 24 VAC.
 Solenoidi disponibili a 12 VDC; 24 VDC; 9 VDC LATCHING
 Pressione min 1.0 bar max 12 bar.
 Portata min 20 l/min max 90 l/min.
 Temperatura min +4°C max 70°C.
 Diametri disponibili 1/2", 3/4" e 1".
INFO SIGLE
 24 VAC = Solenoide 24 VAC premontato.
 Assorbimento allo spunto 0,43 A (Sol. 24 VAC).
 Assorbimento al mantenimento 0,21A (Sol. 24 VAC).

ELETTROVALVOLA PER UNION



Articolo		€ Listino	
9160175	1" M - F	15,52	12

Fibra vetro PA 6 30%
 Membrana in parti costampate per una miglior tenuta in chiusura.
 Astina in acciaio autopulente.
 Molla della membrana in acciaio con azione progressiva.
 Apertura manuale sotto al solenoide.
 Parzializzatore opzionale.
 Solenoide certificato CE, IP 68 9.
 Solenoide standard 24 VAC.
 Solenoidi disponibili a 12 VDC; 24 VDC; 110 VAC; 9 VDC LATCHING
CONDIZIONI D'ESERCIZIO
 Pressione min 1.0 bar max 12 bar.
 Portata min 20 l/min max 90 l/min.
 Temperatura min +4°C max 70°C.



Per informazioni tecniche, foto e prezzi aggiornati visita il nostro sito www.cillisrl.com

**REGOLATORE PRESSIONE
PER ELETTROVALVOLA**



PRO

Articolo	€ Listino	
9160185	60,00	2

SOLENOIDE 24 VOLT 50Hz



Articolo	€ Listino	
9160511	10,00	12

Ricambio per 9160515

POZZETTI PER VALVOLE COMANDI

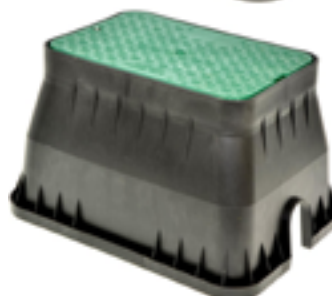
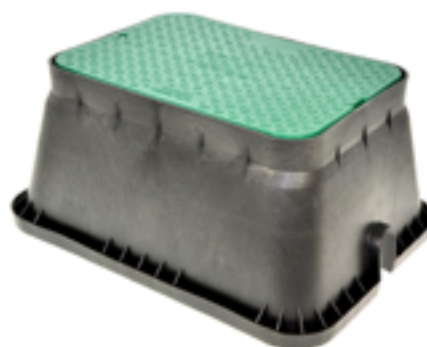

Piccolo-Circolare: base 230mm x Sup.160mm x H.235mm
 Medio-Circolare: base 327mm x Sup.240mm x H.254mm
 Grande-Rettangolare: base504 x 370mm -Sup.400 x 267mm-H.310mm
 Jumbo-Rettangolare: base637 x 500mm -Sup.514 x 363mm- H.310mm

Articolo	Tipo	€ Listino	
9154050	Piccolo	3,60	24
9154080	Medio	6,55	12
9154100	Grande	19,25	6
9154150	Jumbo	35,40	3

**NIPPLO RIDOTTO CON OR
PER COLLETTORI**



Articolo	Ø	€ Listino	
9153419	1" x 3/4"	0,91	50

NIPPLO CON OR PER COLLETTORI



Articolo	Ø	€ Listino	
9153407	1" x 1"	0,96	50

MANICOTTO M/F CON OR PER COLLETTORI



Articolo	Ø	€ Listino	
9153424	1" x 1"	1,64	50

GOMITO F-F CON OR PER COLLETTORI



Articolo	Ø	€ Listino	
9153426	1"	2,55	50

GOMITO M-F CON OR PER COLLETTORI



Articolo	Ø	€ Listino	
9153427	1" x 1"	2,22	50

TEE M-F-F CON OR PER COLLETTORI



Articolo	Ø	€ Listino	
9153431	1" x 1"	2,90	50

TEE M-M-F CON OR PER COLLETTORI



Articolo	Ø	€ Listino	
9153432	1" x 1"	2,55	50

COLLETTORE MANIFOLD GRIGIO



PRO

Articolo	Vie	€ Listino	
9160190	2	5,70	1
9160195	3	8,50	1
9160200	4	11,10	1

• Collettori (manifold) professionali di alta qualità con OR di tenuta - in PVC altamente resistente PN 12,5 - NON necessitano di attrezzi per il montaggio - sistema innovativo per creare gruppi di partenza

IRRIGATORE A TURBINA HUNTER 3/4" F

Hunter®



Articolo	Tipo	€ Listino	
9151500	PGP-ADJ	15,48	

CARATTERISTICHE

Altezza	10 cm
Raggio	da 6,7 a 15,9 mt
Protezione	in gomma sul coperchio
Filtro di protezione	ampio
Frizione	sul pistone
Superficie esposta	40 mm
Rotazione turbina	lubrificata ad acqua
Molla di rientro	pistone in acciaio Inox

Per informazioni tecniche, foto e prezzi aggiornati visita il nostro sito www.cillisrl.com

Hunter® **IRRIGATORE A TURBINA HUNTER 1/2" F**



Articolo	Tipo	€ Listino	
9151550	SRM-04	12,54	25

CARATTERISTICHE	
Altezza	10 cm
Regolazione dell'arco	da 40 a 360 gradi
Opzioni ugello	6
Gamma ugelli	da 0,50 a 3,0
Ugello standard installato in fabbrica	solo 3,0
Regolazione dell'arco	dal lato superiore
Meccanismo rapido	di controllo dell'arco
Ingranaggi	lubrificati ad acqua

Hunter® **POP UP HUNTER CON TESTINA 1°-360° 1/2" F**





Articolo	Tipo	Alzata cm	Altezza cm	€ Listino	
9002918	PSU02-15A	5	12,5	3,24	100
9002920	PSU04-15A	10	17,8	3,24	100
9002925	PSU04-12A	10	17,8	3,24	100
9002927	PSU04-10A	10	17,8	3,24	100

CARATTERISTICHE	
Raggio	da 3,1 a 5,6m
Ampio filtro	di protezione
Vite	di regolazione
Superficie esposta	35 mm
Frizione	sul pistone
Molla di rientro pistone	in acciaio Inox

Raggio	
10A	3,0 m (10')
12A	Testina regolabile da 3,7 m (12')
15A	Testina regolabile da 4,6 m (15')

POP UP PROFESSIONALE 1/2" F



Articolo	Lcm	Ø	€ Listino	
9002900	10	25-360	2,50	100

PROLUNGA FILETTATA 15CM A SEZIONI



Articolo	Filetto	€ Listino	
9152200	1/2" - 1/2"	0,43	100
9152220	3/4" - 1/2"	0,43	100
9152250	3/4" - 3/4"	0,44	100
9152270	1" - 3/4"	0,51	100

Completo di testina

PROLUNGA REGOLABILE 50 CM



Articolo	Tipo	€ Listino	
9152330	1/2" - 1/2"	3,00	100
9152350	3/4" - 3/4"	3,00	105

MODI DI UTILIZZO:



IRRIGATORE STATICO CON TESTINA



Articolo	€ Listino			
9160115	15 A	S020-2 5cm	2,86	100
9160120	15 A	S020-4 10cm	2,86	100
9160125	12 A	S020-4 10cm	2,86	100
9160130	10 A	S020-4 10cm	2,86	100



IRRIGATORE DINAMICO PRO

- CARATTERISTICHE TECNICHE
- Tipo irrigatore dinamico
- Pressione di esercizio min 2.1
- Bar max 5.0 bar
- Portate testine da 1.9 l/min a 32.6 l/min
- Settori regolabili da 40° a 360°
- 360° effettivo
- 8 ugelli intercambiabili con traiettoria 25°
- 4 ugelli intercambiabili con traiettoria 11°
- Ugello 3 premontato
- Raggi da 6.7 m a 15.5 m
- Coperchio in gomma
- Valvola antidrenaggio opzionale
- Attacco 3/4



Articolo	€ Listino			
9160105	S075		13,06	2



IRRIGATORE DINAMICO

- CARATTERISTICHE TECNICHE
- Tipo irrigatore dinamico
- Pressione di esercizio min 2.1 bar max 3.4 bar
- Portate ugelli da 2.8 l/min a 12.5 l/min
- Settori regolabili da 40° a 360°
- 5 ugelli intercambiabili
- Angolo di traiettoria 26°
- Ugello 1.5 premontato
- Raggi da 5.1 m a 9.0 m
- Partenza a destra e rotazione in senso antiorario per il modello S050
- Partenza a sinistra e rotazione in senso orario per il modello S050 s
- Coperchio in gomma per il modello S050
- Coperchio con indicatore di angolo per il modello S050 S
- Valvola antidrenaggio opzionale
- Attacco 1/2



Articolo	€ Listino			
9160110	S050		12,24	2



IRRIGATORE POP-UP A MARTELLETTO SETTORE



Articolo	€ Listino			
9150600			18,00	12



Per informazioni tecniche, foto e prezzi aggiornati visita il nostro sito www.cillisrl.com

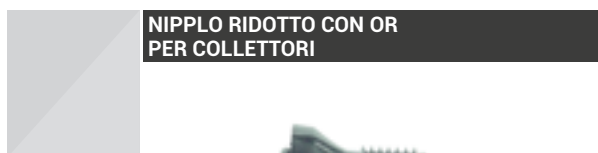

Articolo	Ø	€ Listino	
9153419	1" x 3/4"	0,91	50



Articolo	Ø	€ Listino	
9153407	1" x 1"	0,96	50



Articolo	Ø	€ Listino	
9153424	1" x 1"	1,64	50

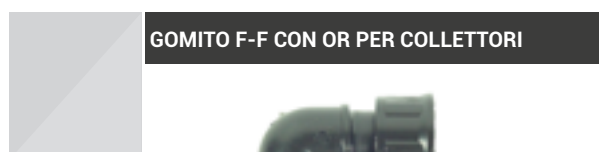

Articolo	Ø	€ Listino	
9153426	1"	2,55	50



Articolo	Ø	€ Listino	
9153427	1" x 1"	2,22	50



Articolo	Ø	€ Listino	
9153431	1" x 1"	2,90	50



Articolo	Ø	€ Listino	
9153432	1" x 1"	2,55	50



PRO			
Articolo	Vie	€ Listino	
9160190	2	5,70	1
9160195	3	8,50	1
9160200	4	11,10	1

• Collettori (manifold) professionali di alta qualità con OR di tenuta in PVC altamente resistente PN 12,5 - NON necessitano di attrezzi per il montaggio - sistema innovativo per creare gruppi di partenza

IRRIGATORE PROFESSIONALE



A



B



C



Articolo	Tipo	Ø	Getti	€ Listino	
9150910	A	1" F settore	1	42,60	6
9150915	A	1" F circolare	1	34,14	6
9150920	B	1" F settore	2	44,88	6
9150925	C	1" F circolare	2	36,80	6

IRRIGATORE PROFESSIONALE



Articolo	Ø	Getti	€ Listino	
9150930	1" 1/4" F settore	1	58,00	6

IRRIGATORE PROFESSIONALE



Articolo	Ø	Getti	€ Listino	
9150952	1" 1/2" F settore	1	71,30	6

CARATTERISTICHE 9150910

Ugelli	intercambiabili.
Ugelli in dotazione	7,5-8-10-12mm
Gittata Max	23,5 ml.
Portata Max	179 l/m

CARATTERISTICHE 9150915

Ugelli	intercambiabili.
Ugelli in dotazione	7,5-8-10-12mm
Gittata Max	23,5 ml.
Portata Max	179 l/m

CARATTERISTICHE 9150920

Primo getto	con ugelli intercambiabili.
Ugelli in dotazione	6,5-8-10mm
Secondo getto	4mm
Gittata Max	21 ml.
Portata Max	156 l/m

CARATTERISTICHE 9150925

Primo getto	con ugelli intercambiabili.
Ugelli in dotazione	6,5-8-10mm
Secondo getto	4mm
Gittata Max	21 ml.
Portata Max	156 l/m

CARATTERISTICHE

Ugelli	intercambiabili.
Ugelli in dotazione	7,5-8-10-12mm
Gittata Max	23,5 ml.
Portata Max	179 l/m

CARATTERISTICHE

Ugelli	intercambiabili.
Ugelli in dotazione	7,5-8-10-12mm
Gittata Max	23,5 ml.
Portata Max	179 l/m

Per informazioni tecniche, foto e prezzi aggiornati visita il nostro sito www.cillisrl.com

IRRIGATORE CIRCOLARE



Articolo	Ø	€ Listino	
9150800	3/4" M	22,00	24

IRRIGATORE CIRCOLARE PLASTICA PROFESSIONALE



Articolo	Ø	€ Listino	
9150750	3/4" M	5,00	40

IRRIGATORE A SETTORE OTTONE IN BLISTER



Articolo	Ø	€ Listino	
9150460	1/2" M	10,00	60

IRRIGATORE CIRCOLARE OTTONE IN BLISTER



Articolo	Ø	€ Listino	
9150455	1/2" M	10,80	40

IRRIGATORE A SETTORE PLASTICA IN BLISTER



Articolo	Ø	€ Listino	
9150501	1/2"	2,50	100

IRRIGATORE A SETTORE PLASTICA IN BUSTA



Articolo	Ø	€ Listino	
9150500	1/2"	3,20	100

IRRIGATORE A SETTORE PLASTICA PROFESSIONALE



Articolo	Ø	€ Listino	
9150505	1/2"	6,00	100

IRRIGATORE A SETTORE METALLO CON PUNTALE



Articolo	Ø	€ Listino	
9150530	1/2"	11,00	30

IRRIGATORE A SETTORE 1/2" IN PLASTICA



Irrigatore battente a settore in ottone e plastica termoindurente modello professionale a impulsi a settore variabile o circolare 14 ml a 4 bar filetto maschio da 1/2" battente antispruzzo.



Articolo	Ø	€ Listino	
9150503	1/2"	6,00	24



IRRIGATORE PLASTICA SETTORE

MANDARIN



PRO

Articolo	Ø	€ Listino	
9150445	1/2" M	6,80	20

IRRIGATORE OTTONE 700L/H

MANDARIN



PRO

Articolo	Ø	€ Listino	
9150625	1/2" M 3.2mm	20,40	6

IRRIGATORE MAGIC DRIVE

MANDARIN



PRO

Articolo	Ø	€ Listino	
9150640	1/2" M - 24° - 3.00mm	10,90	12

ROTOLO TUBO LAYFLAT NDJ

MANDARIN



PRO

Articolo	Lmt	€ Listino	
0610200	2"	400,00	1
0610205	4"	482,00	1

VALVOLA AUTOMATICA SPURGO FINE

MANDARIN



PRO

Articolo	Ø	€ Listino	
9150645	16mm	2,72	50



MINI IRRIGATORE PROFESSIONALE

MANDARIN



PRO

Articolo	Lt/h	Colore	€ Listino	
1721050	105	Verde	0,88	120
1721060	120	Arancione	0,88	120
1721070	200	Blu	0,88	120
1721080	260	Rosso	0,88	120
1721090	300	Nero	0,88	120

STAND 52 PE ATTACCO M RACCORDO F

MANDARIN



PRO

Articolo	Ø	cm	€ Listino	
9150625	1/2" F	120	3,82	40

• Con riduttore da 8.0mm. Non contiene l'asta.

Per informazioni tecniche, foto e prezzi aggiornati visita il nostro sito www.cillisrl.com

IRRIGATORE A SETTORE PLASTICA CON PUNTALE



Articolo	€ Listino	
9150550	3,70	50

PUNTALE IN PLASTICA CON CARD



Articolo	€ Listino	
9150510	1,50	120

• Attacco superiore filettato sia internamente che esternamente. Interno 1/2" F. Esterno 3/4" M.

COLONNETTA PER IRRIGATORE TELESCOPICA



Articolo	Ø	€ Listino	
1866500	1/2"	16,20	20

• Altezza min. 52cm - Altezza max. 84 cm.

COLONNETTA PER IRRIGATORE ZINCATA



Articolo	Ø	€ Listino	
1866525	3/4" M + manicotto F	30,00	5
1866530	1" M	30,00	5
1866540	1-1/4" M	38,00	5
1866550	1-1/2" M	48,00	5

• Robusta colonnella per irrigatore, in metallo zincato. Regolabile in altezza.

RACCORDO A COMPRESSIONE FEMMINA



Articolo	Ø	Mis.	€ Listino	
1001164	16	3/4"	0,72	350
1001165	16	1/2"	0,72	350
1001205	20	1/2"	1,02	355
1001210	20	3/4"	1,02	355
1001255	25	3/4"	1,18	150
1001260	25	1"	1,18	150
1001330	32	3/4"	1,50	150
1001340	32	1"	1,50	150
1001350	32	1.1/4"	2,08	150
1001410	40	1"	2,41	100
1001415	40	1.1/4"	2,56	100
1001515	50	1.1/4"	3,14	100
1001520	50	1.1/2"	3,32	100
1001615	63	1.1/2"	4,83	35
1001620	63	2"	4,83	35
1001725	75	2.1/2"	9,40	18

RACCORDO A COMPRESSIONE MASCHIO



Articolo	Ø	Mis.	€ Listino	
1002165	16	1/2"	0,78	400
1002170	16	3/4"	0,74	400
1002205	20	1/2"	0,94	375
1002210	20	3/4"	0,94	375
1002250	25	1/2"	1,01	200
1002255	25	3/4"	1,08	200
1002260	25	1"	1,08	200
1002330	32	3/4"	1,28	150
1002340	32	1"	1,28	150
1002350	32	1.1/4"	1,43	150
1002410	40	1"	2,37	100
1002415	40	1.1/4"	2,52	100
1002520	50	1.1/2"	3,38	75
1002530	50	2"	3,44	75
1002615	63	1.1/2"	4,40	35
1002620	63	2"	4,66	35
1002725	75	2.1/2"	9,29	18

MANICOTTO A COMPRESSIONE



Articolo	Ø	€ Listino	
1004160	16	1,18	175
1004200	20	1,52	125
1004250	25	1,94	100
1004320	32	2,48	100
1004400	40	4,06	65
1004500	50	5,52	40
1004630	63	7,64	25
1004750	75	15,24	10
1004900	90	19,12	4
1004950	110	40,08	3

MANICOTTO RIDOTTO



Articolo	Ø	€ Listino	
1005200	20x16	1,52	175
1005250	25x20	1,65	150
1005325	32x25	2,28	75
1005450	40x32	3,71	60
1005570	50x40	5,20	40
1005630	63x50	7,50	25
1005750	75x63	13,07	12

GOMITO A 90° CON DEVIAZIONE FEMMINA



Articolo	Ø	€ Listino	
1011165	16 x 1/2"	0,98	250
1011170	16 x 3/4"	0,98	250
1011210	20 x 1/2"	1,22	250
1011220	20 x 3/4"	1,22	200
1011250	25 x 3/4"	1,52	150
1011260	25 x 1"	1,43	125
1011330	32 x 3/4"	1,78	100
1011340	32 x 1"	1,78	100
1011350	32 x 1.¼"	2,14	70
1011415	40 x 1.¼"	3,51	70
1011520	50 x 1.½"	4,41	50
1011620	63 x 2"	6,42	25

GOMITO A 90° CON DEVIAZIONE MASCHIO



Articolo	Ø	€ Listino	
1012165	16 x 1/2"	0,97	200
1012210	20 x 1/2"	1,02	250
1012220	20 x 3/4"	1,02	250
1012240	25 x 1/2"	1,24	175
1012250	25 x 3/4"	1,24	175
1012260	25 x 1"	1,44	200
1012340	32 x 1"	1,59	100
1012415	40 x 1.¼"	2,54	100
1012420	40 x 1.½"	2,54	100

GOMITO A COMPRESIONE 90°



Articolo	Ø	€ Listino	
1010160	16 x 16	1,19	140
1010200	20 x 20	1,52	140
1010250	25 x 25	1,85	180
1010320	32 x 32	2,56	100
1010400	40 x 40	4,30	50
1010500	50 x 50	5,96	35
1010630	63 x 63	7,62	15
1010750	75 x 75	15,80	8
1010900	90 x 90	18,47	5
1010950	110 x 110	36,18	1

Per informazioni tecniche, foto e prezzi aggiornati visita il nostro sito www.cillisrl.com

TEE A 90° CON DEVIAZIONE FEMMINA



Articolo	Ø	€ Listino	
1007165	16 x 1/2" x 16	1,34	125
1007170	16 x 3/4" x 16	1,34	125
1007210	20 x 1/2" x 20	1,70	125
1007220	20 x 3/4" x 20	1,70	125
1007240	25 x 1/2" x 25	2,16	75
1007250	25 x 3/4" x 25	2,02	75
1007260	25 x 1" x 25	2,25	75
1007330	32 x 3/4" x 32	2,79	45
1007340	32 x 1" x 32	2,79	45
1007415	40 x 1.1/4" x 40	5,10	35
1007520	50 x 1.1/2" x 50	6,54	25
1007620	63 x 2" x 63	9,62	25
1007930	90 x 3"x90	23,40	1
1007994	110 x 4" x 110	38,88	2

TEE A 90° CON DEVIAZIONE MASCHIO



Articolo	Ø	€ Listino	
1008165	16 x 1/2" x 16	1,60	150
1008205	20 x 1/2" x 20	1,78	150
1008210	20 x 3/4" x 20	1,78	150
1008255	25 x 3/4" x 25	2,19	100
1008260	25 x 1" x 25	2,19	100
1008340	32 x 1" x 32	2,75	60
1008620	63 x 2" x 63	13,77	16

TEE A COMPRESSIONE 90°



Articolo	Ø	€ Listino	
1009160	16 x 16	1,55	100
1009200	20 x 20	2,10	80
1009250	25 x 25	2,79	100
1009320	32 x 32	3,60	30
1009400	40 x 40	5,96	30
1009500	50 x 50	7,65	20
1009630	63 x 63	10,91	12
1009750	75 x 75	22,10	5
1009900	90 x 90	23,40	2

TAPPO A COMPRESSIONE



Articolo	Ø	€ Listino	
1003160	16	0,81	400
1003200	20	1,03	400
1003250	25	1,14	250
1003320	32	1,40	200
1003400	40	2,35	110
1003500	50	3,47	75
1003630	63	4,70	40
1003750	75	12,75	18
1003900	90	14,26	10

GOMITO PER POP-UP PN10



Articolo	Ø	€ Listino	
1012100	32 x 3/4"	2,73	150
1012105	25 x 1/2"	2,24	150



**MANICOTTO X TAPE
CON GHIERA FLOTTANTE**



Articolo	Ø	€ Listino	
1770016	16	0,17	100

**DEVIAZIONE X TAPE
CON GOMMA E GHIERA FLOTTANTE**



Articolo	Ø	€ Listino	
1770026	16/D	0,17	100

**TEES X TAPE
CON GHIERA FLOTTANTE**



Articolo	Ø	€ Listino	
1770036	16	0,67	50

**TEES X ALA GOCCIOLANTE
LEGGERA**



Articolo	Ø	€ Listino	
1770046	16/D	0,81	50

**GOMITO X TAPE
CON GHIERA FLOTTANTE**



Articolo	Ø	€ Listino	
1770056	16	0,56	50

**VALVOLINA JOLLY X TAPE
CON GHIERA FLOTTANTE**



Articolo	Ø	€ Listino	
1770066	16x16	0,59	100

**VALVOLINA JOLLY FM X TAPE
CON GHIERA FLOTTANTE**



Articolo	Ø	€ Listino	
1770076	16x3/4"	0,52	100

**VALVOLINA JOLLY FM X TAPE
CON GHIERA FLOTTANTE**



Articolo	Ø	€ Listino	
1770086	16/D	0,52	100

Per informazioni tecniche, foto e prezzi aggiornati visita il nostro sito www.cillisrl.com

VALVOLINA JOLLY X TAPE CON GHIERA FLOTTANTE



Articolo	Ø	€ Listino	
1770096	16x16	0,56	100

PRESA A STAFFA SEMPLICE



Articolo	Ø	€ Listino	
1400251	25 x 1/2"	0,82	180
1400252	25 x 3/4"	0,82	180
1400321	32 x 1/2"	0,96	180
1400322	32 x 3/4"	0,96	180
1400323	32 x 1"	0,96	180
1400401	40 x 1/2"	0,97	150
1400402	40 x 3/4"	0,92	150
1400403	40 x 1"	1,00	150
1400501	50 x 1/2"	1,18	100
1400502	50 x 3/4"	1,18	100
1400503	50 x 1"	1,18	100
1400631	63 x 3/4"	1,68	100
1400632	63 x 1"	1,68	100
1400633	63 x 1 1/4"	1,68	100
1400752	75 x 3/4"	1,89	50
1400753	75 x 1"	2,24	50
1400754	75 x 1 1/4"	2,24	50
1400902	90 x 3/4"	2,68	40
1400903	90 x 1"	2,80	50

MANICOTTO IN P P



Articolo	Ø	€ Listino	
1470010	1/2" x 1/2"	0,67	900
1470015	3/4" x 3/4"	0,70	700
1470020	1" x 1"	0,81	400
1470025	1 1/4" x 1 1/4"	1,42	250
1470030	1 1/2" x 1 1/2"	1,92	200
1470035	2" x 2"	3,06	80
1470040	2 1/2" x 2 1/2"	10,50	200
1470045	3" x 3"	12,50	80

NIPLO 1 PLP



Articolo	Ø	€ Listino	
1460005	1/2"	0,14	1000
1460008	3/4"	0,15	1500
1460010	1"	0,185	800
1460014	1 1/4"	0,46	500
1460015	1 1/2"	0,54	500
1460020	2"	1,02	500
1460025	2 1/2"	1,82	500
1460030	3"	2,74	500

NIPLO RIDOTTO



Articolo	Ø	€ Listino	
1462010	3/4" x 1/2"	0,16	2000
1462015	1" x 3/4"	0,22	1400
1462020	1 1/4" x 1"	0,40	800
1462025	1 1/2" x 1 1/4"	0,68	400
1462030	2 x 1 1/2"	1,06	300
1462035	2 1/2" x 2"	2,67	200
1462040	3" x 2 1/2"	2,97	100

MANICOTTO RIDOTTO



Articolo	Ø	€ Listino	
1471015	3/4" x 1/2"	0,67	700
1471020	1" x 3/4"	0,79	500
1471025	1 1/4" x 1"	1,14	120
1471030	1 1/2" x 1 1/4"	1,80	200
1471035	2" x 1 1/2"	2,94	140
1471040	2" x 2 1/2"	7,07	40
1471045	3" x 2 1/2"	10,13	50

RIDUZIONE F M



Articolo	Ø	€ Listino	
1472011	3/4" F x 1/2" M	0,49	500

TAPPO MASCHIO



Articolo	Ø	€ Listino	
1462510	1/2"	0,18	3000
1462515	3/4"	0,22	2200
1462520	1"	0,26	1000
1462525	1.¼"	0,48	500
1462530	1.½"	0,62	500
1462535	2"	0,96	500

CALOTTA FEMMINA



Articolo	Ø	€ Listino	
1463510	1/2"	0,25	3000
1463515	3/4"	0,25	2200
1463520	1"	0,20	1200
1463525	1.¼"	0,80	600
1463535	2"	0,86	600

BUSSOLA DI RIDUZIONE M-F IN P P



Articolo	Ø	€ Listino	
1472010	3/4" x 1/2"	0,51	500
1472015	1" x 1/2"	0,62	250
1472020	1" x 3/4"	0,62	250
1472025	1.¼" x 1/2"	0,98	250
1472030	1.¼" x 3/4"	0,98	250
1472035	1.¼" x 1"	0,98	250
1472040	1.½" x 3/4"	1,51	250
1472045	1.½" x 1"	1,51	250
1472050	1.½" x 1.¼"	1,60	250
1472055	2" x 3/4"	2,01	300
1472060	2" x 1"	2,14	250
1472065	2" x 1.¼"	2,14	250
1472070	2" x 1.½"	2,14	250
1472075	2.½" x 2"	3,00	250
1472080	3" x 2"	4,11	250
1472090	3" x 2.½"	4,14	250

MANICOTTO PER ALA GOCCIOLANTE



Articolo	Ø	€ Listino	
1610400	16	0,13	1000
1610405	20	0,15	1000

MANICOTTO PORTAGOMMA



Articolo	Ø	€ Listino	
1440016	16 x 16	0,064	100
1440020	20 x 20	0,07	100
1440025	25 x 25	0,17	50
1440032	32 x 32	0,18	50
1440040	40 x 40	0,36	25
1440050	50 x 50	1,05	3
1440063	63 x 63	1,52	3
1440075	75 x 75	2,83	3

Per informazioni tecniche, foto e prezzi aggiornati visita il nostro sito www.cillisrl.com

MANICOTTO RIDOTTO PORTAGOMMA-PORTAGOMMA



Articolo	Ø	€ Listino	
1440116	20 x 16	0,24	2000
1440120	25 x 16	0,26	900
1440125	25 x 20	0,32	900
1440132	32 x 25	0,34	500
1440140	40 x 32	0,58	350

MANICOTTO PER TAPE



Articolo	Ø	€ Listino	
1610430	16 x 16	0,20	800

DERIVAZIONE CON GOMMINO PER TAPE



Articolo	Ø	€ Listino	
1610410	16 x 16	0,20	1400

RACCORDO MASCHIO PER TAPE



Articolo	Ø	€ Listino	
1610420	16 x 1/2"	0,16	1000
1610425	16 x 3/4"	0,28	1000

MANICOTTO CON PORTAGOMMA PER TAPE



Articolo	Ø	€ Listino	
1610435	16 x 16	0,18	1000

RACCORDO MANICOTTO PORTAGOMMA



Articolo	Ø	€ Listino	
1445016	16 x 3/4"	0,22	1600
1445017	16 x 1/2"	0,22	1400
1445020	20 x 1/2"	0,22	1800
1445021	20 x 3/4"	0,22	1500
1445025	25 x 3/4"	0,24	1000
1445026	25 x 1"	0,24	600
1445031	32 x 3/4"	0,28	600
1445032	32 x 1"	0,28	500
1445033	32 X 1"1/4	0,28	250
1445040	40 x 1"	0,36	250
1445041	40 x 1.1/4"	0,44	250
1445055	50 x 1.1/2"	0,98	250
1445063	63 x 2"	3,80	50

RACCORDO CON GHIERA



Articolo	Ø	€ Listino	
1445110	16 x 1/2"	0,35	1300
1445115	16 x 3/4"	0,44	1200
1445120	20 x 3/4"	0,60	1000
1445125	25 x 1	0,74	400
1445128	25 x 1.1/4	0,79	300
1445130	32 x 1.1/4	0,86	350

DEVIAZIONE A CORPO UNICO
CON GOMMINO



Articolo	Ø	€ Listino	
1765516	16	0,09	2500
1765520	20	0,12	2500

DEVIAZIONE CON GOMMINO



Articolo	Ø	€ Listino	
1765600	3/4" M x 12	0,14	2000
1765650	1" M x 16	0,14	2000

GOMITO 90° FEMMINA - FEMMINA IN P P



Articolo	Ø	€ Listino	
1490010	1/2" x 1/2"	0,65	250
1490015	3/4" x 3/4"	0,71	250
1490020	1" x 1"	0,96	250
1490025	1.¼" x 1.¼"	1,64	250
1490030	1.½" x 1.½"	3,47	250
1490035	2" x 2"	4,69	10

GOMITO 90° MASCHIO - FEMMINA IN P P



Articolo	Ø	€ Listino	
1491010	1/2" x 1/2"	0,63	700
1491015	3/4" x 3/4"	0,68	700
1491020	1" x 1"	0,78	350

T A 90° FEMMINA IN P P



Articolo	Ø	€ Listino	
1495010	1/2" x 1/2" x 1/2"	0,88	500
1495015	3/4" x 3/4" x 3/4"	0,99	300
1495020	1" x 1" x 1"	1,18	200
1495025	1.¼" x 1.¼" x 1.¼"	2,08	200
1495030	1.½" x 1.½" x 1.½"	4,14	100
1495035	2" x 2" x 2"	6,31	60
1495045	3" x 3" x 3"	20,63	60

TEE A 90° PORTAGOMMA



Articolo	Ø	€ Listino	
1493016	16 x 16 x 16	0,10	1500
1493020	20 x 20 x 20	0,22	1000
1493025	25 x 25 x 25	0,49	700
1493032	32 x 32 x 32	0,62	250
1493040	40 x 40 x 40	0,87	250

Per informazioni tecniche, foto e prezzi aggiornati visita il nostro sito www.cillisrl.com

T A 90° PORTAGOMMA CON FILETTO MASCHIO



Articolo	Ø	€ Listino	
1494016	16 x 1/2" x 16	0,22	1700
1494017	16 x 3/4" x 16	0,22	1500
1494020	20 x 1/2" x 20	0,32	600
1494021	20 x 3/4" x 20	0,40	800
1494025	25 x 1/2" x 25	0,44	1000
1494026	25 x 3/4" x 25	0,50	1000
1494027	25 x 1" x 25	0,42	400
1494032	32 x 1" x 32	0,68	250
1494040	40 x 1" x 40	0,74	120

T A 90° FILETTO MASCHIO IN P P



Articolo	Ø	€ Listino	
1495110	1/2" x 1/2" x 1/2"	0,38	1000
1495125	3/4" x 1" x 3/4"	0,54	400
1495130	1" x 1" x 1"	0,78	300
1495135	1" x 1/4" x 1"	0,78	300

GOMITO A 90° PORTAGOMMA



Articolo	Ø	€ Listino	
1440516	16 x 16	0,14	2000
1440520	20 x 20	0,16	1500
1440525	15 x 15	0,38	1000
1440532	32 x 32	0,59	400
1440540	40 x 40	0,88	400

CURVA TAPE



Articolo	Ø	€ Listino	
1610465	16 x 16	0,84	300

GOMITO A 90° FILETTATO MASCHIO + PORTAGOMMA



Articolo	Ø	€ Listino	
1492116	16 x 1/2"	0,22	2000
1492120	20 x 1/2"	0,24	1600
1492121	20 x 3/4"	0,24	1200
1492125	25 x 3/4"	0,51	800

TEE TAPE MASCHIO



Articolo	Ø	€ Listino	
1610475	16 x 16 X 16	0,86	400

RACCORDO A Y



Articolo	Ø	€ Listino	
1496015	3/4" x 16 x 16	1,14	300
1496020	3/4" x 25 x 25	1,88	300
1496025	1" x 25 x 25	1,97	200
1496030	1" x 32 x 32	1,99	160

RACCORDO A 3 VIE



Articolo	Ø	€ Listino	
1496010	3/4" x 16 x 16 x 16	0,96	300

SET 10 TAPPINI



Articolo	Lmm	€ Listino	
1725434	5	0,50	100

TAPPETTO AD INNESTO



Articolo	Ø	€ Listino	
1441004	4	0,026	3500
1441006	6	0,036	3500
1441008	8	0,042	3500
1441010	10	0,050	3500

TAPPO CON GOMMINO



Articolo	Lmm	€ Listino	
1441011	10,5	0,07	6000

TAPPO



Articolo	Lmm	€ Listino	
1441016	16	0,054	5000
1441020	20	0,07	6000

GANCIO PER TUBI



Articolo	Ø	€ Listino	
1455016	16	0,04	6000
1455020	20	0,06	4000
1455032	32	0,12	2000

PICCHETTO PER ALA GOCCIOLANTE



Articolo	Ø	€ Listino	
1455036	16	0,16	5000
1455040	20	0,18	6000

Per informazioni tecniche, foto e prezzi aggiornati visita il nostro sito www.cillisrl.com

GOCCIOLATORE A LABIRINTO REGOLABILE



Articolo	Lt/h	€ Listino	
1700100	3 - 70	0,17	1000

GOCCIOLATORE A LABIRINTO ISPEZIONABILE



Articolo	Lt/h	€ Listino	
1700005	5	0,12	3000
1700010	8	0,12	3000
1700015	15	0,12	3000

GOCCIOLATORE AUTOCOMPENSANTE A LABIRINTO ISPEZIONABILE



Articolo	Lt/h	€ Listino	
1700050	2	0,20	3600
1700055	4	0,20	3600
1700060	8	0,20	3600
1700065	15	0,20	3600

GOCCIOLATORE SIGARO ISPEZIONABILE



Articolo	Lt/h	€ Listino	
1700110	10	0,18	1000
1700115	16	0,18	1000

NEBULIZZATORE 360° FARFALLA



Articolo	Ø Foro	€ Listino	
1705020	2,0	0,19	400
1705025	2,5	0,19	400
1705030	3,0	0,19	400
1705035	3,5	0,19	400
1705040	4,0	0,19	400

MICROSPRUZZI

• Gli ugelli dal 1.0 al 3.0 Multipli di 500



Articolo	Tipo	€ Listino	
1712180	A 180°	0,06	3000
1712360	A 360°	0,06	3000
1712410	B 1,0	0,06	3000
1712412	B 1,2	0,06	3000
1712415	B 1,5	0,06	3000
1712420	B 2,0	0,066	3000
1712422	B 2,2	0,066	3000

MINI IRRIGATORE



Articolo	Lt/h	Colore	€ Listino	
1721009	90	Verde	0,36	500
1721013	130	Rosso	0,36	500
1721015	150	Giallo	0,36	500
1721027	270	Marrone	0,36	500
1721030	300	Grigio	0,36	500

ASTINA GOCCIOLATORE



Articolo	Lt/h	€ Listino	
1700210	2	0,09	1000

ASTINA PER MICROTUBO



Articolo	Ø Foro	€ Listino	
1700200	5,5 / 6 mm	0,07	1000

INNESTINO AD OLIVETTA PER MICROTUBO



Articolo	Ø	€ Listino	
1765110	4	0,11	500
1765113	3,5 x 6	0,07	500
1765115	5 x 8	0,05	500

MANICOTTO



Articolo	Ø	€ Listino	
1765112	5 x 8	0,06	3000

COLLETTORE 6 USCITE PER MICROTUBO

Articolo	€ Listino	
1765260	0,20	500

TUBICINO PVC MORBIDO FLANGIA

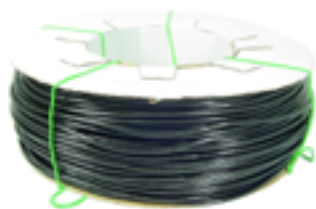

Articolo	Lcm	€ Listino/Kg	
1765013	3,5 x 5,5	4,78	50 kg
1765015	5 x 8	4,78	50 kg

ADATTATORE FILETTATO



Articolo	Ø	€ Listino	
1765105 A	4 x 6,5	0,08	2500
1765103 B	3,5 x 6	0,08	2500

CONFEZIONI DA 500 PZ INNESTINO AD OLIVETTA PER MICROTUBO



Articolo	Ø	€ Listino	
1765119	3,5 x 3,5	10,00	10

MICRO T 90



Articolo	Ø	€ Listino	
1765750	3,5	0,16	3500



ROTOLO TUBO MICROPOROSO NERO



Articolo	Lmt	Ø	€ Listino	
1790100	100	12 mm	60,00	1-

PRO

• OGNI ROTOLO E' DI CIRCA 7-8 KG e sono lunghi 100-150 mt a seconda dello spessore
 - 3,5x5,5: L'unghezza singolo rotolo CIRCA 150mt Prezzo al kg
 - 5x8: L'unghezza singolo rotolo CIRCA 100mt Prezzo al kg

**ROTOLO ALA GOCCIOLANTE DOUBLE
DOPPIO FORO 4 LT/H**

PRO  

Articolo	Lmt	Ø	€ Listino	
1782105	50	16-20 cm	19,60	80
1782110	50	16-33 cm	14,10	80
1782120	100	16-33 cm	27,60	40

• Tubo gocciolante professionale 4 litri orari.
Ogni gocciolatore Double ha 2 file da 3 fori.



**ROTOLO ALA GOCCIOLANTE DOUBLE
DOPPIO FORO 4 LT/H**

PRO  

Articolo	Lmt	Ø	€ Listino	
1781620	400	16-20 cm	137,20	1
1781635	400	16-30 cm	101,00	1
1781645	400	16-40 cm	97,50	1
1781650	400	16-50 cm	97,50	1
1781660	400	16-60 cm	92,00	1

• Tubo gocciolante professionale 4 litri orari.
Ogni gocciolatore Double ha 2 file da 3 fori.



**ROTOLO ALA GOCCIOLANTE
AUTOCOMPENSANTE FORO SINGOLO 4 LT/H**

PRO  

Articolo	Lmt	Ø	€ Listino	
1782125	100	16-33 cm	60,90	20

• Gocciolante autocompensante singolo a tre fori.



**TUBO GOCCIOLATORE JUN
PLURISTAGIONALE**

PRO  

Articolo	Lmt	Ø	€ Listino	
1782140	50	16-33 cm	17,88	8
1782150	100	16-33 cm	33,00	4
1782160	400	16-43 cm	122,52	1

• Tubo gocciolante pluristagionale con portata variabile in funzione della pressione di esercizio.



MANICHETTA GOCCIOLANTE 2 LT/H

PRO 

Articolo	Mil	Ø	€ Listino	
1791621	8	16 x 20	0,12	2000MI
1791630	18	16 x 30	0,15	1000MI
1791631	8	16 x 30	0,12	2000MI

• Manichetta schiacciata professionale.



MANICHETTA GOCCIOLANTE 2 LT/H

PRO 

Articolo	Lmt	Ø	€ Listino	
1791704	100	16 x 10	17,60	24
1791707	100	16 x 20	12,00	24
1791710	100	16 x 30	12,00	24
1791715	250	16 x 10	36,20	24
1791720	250	16 x 20	26,50	24
1791725	250	16 x 30	26,50	24

• Manichetta schiacciata professionale.



ROTOLO TUBO POLIETILENE PN6

 PRO

Articolo	Lmt	Ø	€ Listino	
0630616	100	16	28,34	1
0630620	100	20	38,00	1
0630625	100	25	58,62	1
0630632	100	32	90,80	1
0630640	100	40	138,00	1



ROTOLO TUBO PVC SPIRALATO

CILLI TEK III



Articolo	Lmt	Ø	€ Listino	
0600020	50	20	72,52	1
0600025	50	25	90,80	1
0600030	50	30	123,08	1
0600035	50	35	147,38	1
0600040	50	40	178,96	1
0600045	50	45	240,18	1
0600050	50	50	247,24	1
0600060	50	60	369,50	1



ROTOLO TUBO SPIRALATO STEEL

CILLI TEK III

mm	inch	mm	inch	bar	psi	cm	inch	%	kg/m	lb/ft
16	5/8	20	0,87	6	80	64	2,83	96	0,290	0,170
18	3/4	26	1,00	6	90	73	2,75	96	0,300	0,216
20	3/4	26	1,16	5	75	89	3,69	96	0,340	0,250
25	1	30	1,26	5	75	106	4,09	96	0,520	0,300
30	1 3/16	36	1,50	4	60	126	4,75	96	0,620	0,420
35	1 3/8	45	1,77	4	60	146	5,53	96	0,820	0,540
40	1 9/16	50	1,97	3	45	160	6,25	96	0,895	0,635
45	1 3/4	56	2,17	3	45	180	7,00	96	1,100	0,740
51	2	61	2,40	3	45	204	8,00	96	1,220	0,830
60	2 3/8	72	2,83	2	30	240	9,50	96	1,700	1,140



Articolo	Lmt	Ø	€ Listino	
0610016	60	16	137,76	1
0610018	60	18	171,88	1
0610020	60	20	178,54	1
0610025	60	25	270,16	1
0610030	60	30	318,53	1
0610035	60	35	362,88	1
0610040	30	40	243,93	1
0610045	30	45	287,28	1
0610050	30	50	293,00	1
0610060	30	60	303,00	1



VALVOLA A SFERA



Articolo	Ø	€ Listino	CFM
1610616	3/4" x 16	0,54	50
1610620	3/4" x 20	0,56	50
1610625	3/4" x 25	0,56	50
1610750	1" F x 32	0,90	50

VALVOLA A SFERA



Articolo	Ø	€ Listino	CFM
1610600	3/4"+ T	0,59	50

VALVOLA A SFERA



Articolo	Ø	€ Listino	CFM
1610520	3/4" x 3/4" FF	0,80	50
1610710	1" x 1" FF	1,44	50

VALVOLA A SFERA



Articolo	Ø	€ Listino	CFM
1610500	3/4" M - F	0,52	50
1610720	1" F x 1" M	0,90	50

VALVOLA A SFERA



Articolo	Ø	€ Listino	CFM
1610740	1" F x 25	0,90	50

VALVOLA A SFERA



Articolo	Ø	€ Listino	CFM
1610745	3/4" F x 25	0,90	50



Per informazioni tecniche, foto e prezzi aggiornati visita il nostro sito www.cillisrl.com

MINI VALVOLA PORTAGOMMA + PORTAGOMMA



Articolo	Ø	€ Listino	
1620116	16 x 16	0,48	1000
1620120	20 x 20	0,50	1000

MINI VALVOLA MASCHIO + MASCHIO



Articolo	Ø	€ Listino	
1620212	1/2" M x 1/2" M	0,50	300
1620234	3/4" M x 3/4" M	0,50	250

MINI VALVOLA MASCHIO + PORTAGOMMA



Articolo	Ø	€ Listino	
1620412	1/2" x 16	0,50	500
1620417	1/2" x 20	0,50	300
1620434	3/4" x 16	0,50	300
1620445	3/4" x 20	0,50	500

MINI VALVOLA MASCHIO+TAPE



Articolo	Ø	€ Listino	
1620312	1/2" x Tape	0,52	300
1620334	3/4" x Tape	0,52	250

MINI VALVOLA GOMMINO+PORTAGOMMA



Articolo	Ø	€ Listino	
1620512	16 x 16	0,49	400
1620520	16 x 20	0,49	300

MINI VALVOLA GOMMINO+MASCHIO



Articolo	Ø	€ Listino	
1620712	16 x 1/2"	0,49	300

MINI VALVOLA GOMMINO + TAPE



Articolo	Ø	€ Listino	
1620616	16 x Tape	0,51	300

VALVOLA GOMMINO+ALA



Articolo	Ø	€ Listino	
1621110	G + ALA 16	0,51	300
1621120	G + ALA 20	0,51	250

VALVOLA PORTAGOMMA



Articolo	Ø	€ Listino	
1611216	16 x 16	0,40	500
1611220	20 x 20	0,40	500

MICROVALVOLA



Articolo	Lmm	€ Listino	
1765250	5 x 6	0,50	100

VALVOLA A SFERA



Articolo	Ø	PN	€ Listino	
1610060	3/4" F - M	10	2,09	100
1610150	1" F - M	10	2,09	100
1610255	1.¼" F - M	16	4,60	40
1610260	1.½" F - M	16	7,32	25
1610265	2" F - M	16	10,42	13



VALVOLA BIGHIERA A SFERA



Articolo	Ø	PN	€ Listino	
1610110	1" F - F	10	3,30	50



VALVOLA A SFERA



Articolo	Ø	PN	€ Listino	
1610050	3/4" F - F	10	2,09	60
1610100	1" F - F	10	2,12	60
1610155	1.¼" F - F	16	4,72	40
1610160	1.½" F - F	16	7,48	25
1610165	2" F - F	16	10,42	13



Per informazioni tecniche, foto e prezzi aggiornati visita il nostro sito www.cillisrl.com

VALVOLA SFERA OTTONE F-M



PRO

Articolo	Ø	€ Listino	
1910110	1/2" F - M	5,94	60
1910120	3/4" F - M	8,70	30
1910130	1" F - M	12,58	20
1910140	1.¼" F - M	20,60	12
1910150	1.½" F - M	23,00	12
1910160	2" F - M	38,20	6

VALVOLA SFERA OTTONE F-F



PRO

Articolo	Ø	€ Listino	
1910210	1/2" F - F	5,68	60
1910220	3/4" F - F	8,72	30
1910230	1" F - F	12,10	20
1910240	1.¼" F - F	21,18	12
1910250	1.½" F - F	25,58	12
1910260	2" F - F	45,32	6
1910275	2 ½" F - F	76,58	2
1910285	3" F - F	127,72	2

RUBINETTO A SFERA OTTONE PER EROGAZIONE



PRO

Articolo	Ø	€ Listino	
1920016	1/2"	8,40	48
1920022	3/4"	10,82	30
1920025	1"	15,38	16

RUBINETTO A SFERA OTTONE CON PORTALUCCHETTO



PRO

Articolo	Ø	€ Listino	
1921260	3/4"	9,40	72

RUBINETTO A SFERA OTTONE CON PORTALUCCHETTO



Articolo	Ø	€ Listino	
1921020	1/2"	8,60	72
1921025	3/4"	8,80	72

RUBINETTO CLASSICO OTTONE



Articolo	Ø	€ Listino	
1920050	1/2"	7,60	24

RUBINETTO CLASSICO OTTONE SENZA BECCUCCIO



Articolo	Ø	€ Listino	
1920065	3/4"	5,50	12

RUBINETTO OTTONE OLD FUSION



Articolo	Ø	€ Listino	
8610105	1/2"	30,00	6

VALVOLA DI RITEGNO OTTONE



Articolo	Ø	€ Listino	
1900600	1/2"	4,17	12
1900605	3/4"	6,29	12
1900610	1"	8,36	12
1900615	1.¼"	12,05	12
1900620	1.½"	17,47	12

VALVOLA DI FONDO OTTONE



Articolo	Ø	€ Listino	
1900625	3/4"	11,00	12
1900630	1"	12,20	12
1900635	1.¼"	19,30	12
1900640	1.½"	24,40	12

VALVOLA DI RITEGNO CLAPET SEDE GOMMA



Articolo	Ø	€ Listino	
1900545	3/4"	11,90	12
1900550	1"	17,64	12
1900555	1.¼"	25,74	12

NASTRO TEFLON SET 3 PEZZI



Articolo	Lmt	€ Listino	
3150030	12 x 10	0,70	240

NASTRO TEFLON



Articolo	Lmt	€ Listino	
3150060	12 x 10	0,30	1200
3150070	19 x 10	0,50	600
3150080	25 x 10	0,65	600

FASCETTE STRINGITUBO



Articolo	Ø	Lmm	€ Listino	
0400010	10-16mm	8	0,17	2000
0400011	13-19mm	8	0,17	2000
0400012	16-23mm	8	0,18	2000
0400015	13-19mm	13	0,26	2000
0400016	19-27mm	13	0,26	1000
0400023	23-36mm	13	0,37	1000
0400030	29-47mm	13	0,40	1000
0400032	32-51mm	13	0,42	1000
0400040	40-64mm	13	0,44	1000
0400070	70-90mm	12	0,57	1000
0400080	80-100mm	12	0,57	1000

Per informazioni tecniche, foto e prezzi aggiornati visita il nostro sito www.cillisrl.com

SET 6 FASCETTE



Articolo	€ Listino	
9896036	0,60	100
9896038	0,60	100
9896040	0,63	100

9896036: 3PZ x Ø 8-18mm - 2PZ x Ø 13-23mm - 1PZ x Ø 14-27mm

9896038: 6PZ x Ø 8-18 mm

9896040: 6PZ x Ø 13-23 mm

BOX 100 FASCETTE PROF



PRO

Articolo	Ø	Lmm	€ Listino	
0400108	8-12 mm	8	22,40	20

BOX 50 FASCETTE PROF



PRO

Articolo	Ø	Lmm	€ Listino	
0400110	10-16 mm	8	11,22	40
0400114	14-24 mm	8	12,92	24
0400118	18-28 mm	8	14,00	24

BOX 25 FASCETTE PROF



PRO

Articolo	Ø	Lmm	€ Listino	
0400211	11-23 mm	13	9,00	24
0400214	14-27 mm	13	9,00	24
0400219	19-38 mm	13	12,00	24
0400227	27-51 mm	13	13,00	12
0400230	40-64 mm	13	13,80	8
0400265	65-89 mm	13	14,80	8

COLLARE STRINGITUBO A BANDA LARGA



PRO

Articolo	Ø	Lmm	Spess.	€ Listino	
0430017	17-19	20	0,8	0,58	100
0430020	20-22	20	0,8	0,60	100
0430023	23-25	20	0,8	0,62	100
0430025	25-27	20	0,8	0,76	100
0430026	26-28	20	0,8	0,80	100
0430029	29-31	20	0,8	0,84	100
0430032	32-35	20	0,8	0,88	100
0430036	36-39	20	0,8	0,96	100
0430040	40-43	20	0,8	1,00	100
0430044	44-47	22	1,2	1,24	50
0430048	48-51	22	1,2	1,26	50
0430052	52-55	22	1,2	1,28	50
0430056	56-59	22	1,2	1,30	50
0430060	60-63	22	1,2	1,38	50
0430064	64-67	22	1,2	1,40	50
0430068	68-73	22	1,2	1,48	50
0430074	74-79	24	1,5	2,08	50
0430080	80-85	24	1,5	2,12	50
0430086	86-91	24	1,5	2,14	50
0430092	92-97	24	1,5	2,28	50
0430098	98-103	24	1,5	2,30	100
0430105	104-112	24	1,5	2,60	50

FUSTELLA FORATUBI



Articolo	Ø	€ Listino	
1690200	25-32	5,00	12

FASCETTE STRINGITUBO RAPIDO



Articolo	Ø	€ Listino	
1455120	21,5-19	0,08	1000

**FUSTELLA FORATUBI
FILETTO 12mm**



Articolo	Ø	€ Listino	
1690025	2,5	5,00	12
1690030	3,0	5,00	12
1690036	3,6	5,00	12
1690040	4,0	5,00	12
1690050	5,0	5,00	12
1690060	6,0	5,00	12
1690070	7,0	5,00	12
1690080	8,0	5,00	12

**FUSTELLA FORATUBI
FILETTO 12mm**



Articolo	Ø	€ Listino	
1690100	10,0	5,50	12

**PUNZONE PER FUSTELLA
FILETTO 13mm**



Articolo	Ø	€ Listino	
1690505	1,0	1,50	6
1690508	1,7	2,00	6
1691025	2,5	1,50	6
1691030	3,0	1,50	6
1691036	3,6	1,50	6
1691040	4,0	1,50	6
1691050	5,0	1,50	6
1691060	6,0	1,50	6
1691070	7,0	1,50	6
1691080	8,0	1,50	6
1691090	9,0	1,50	6
1691100	10,0	1,50	6

**PUNZONE PER FUSTELLA
FILETTO 12mm**



Articolo	Ø	€ Listino	
1691165	2,5	1,94	6
1691170	3,0	1,94	6
1691175	3,6	1,94	6
1691185	5,0	1,94	6
1691195	7,0	1,94	6
1691200	8,0	1,94	6
1691205	9,0	1,94	6
1691210	10,0	1,94	6

PINZA FORATUBI PER INNESTI



PRO

Articolo	Ø Punzone	€ Listino	
1690500	10 mm	80,00	1

Capacità Foro: Min 30mm - Max 110mm.
Attacco 3/8 Gas.
Lunghezza totale 80 cm

**FUSTELLA BETA
TESTINA MULTIPLA**



PRO

Articolo	Ø	€ Listino	
1690350	4-6-8-10	19,74	10

RICAMBIO INNESTI PINZONE



Articolo	Ø Filetto	€ Listino	
1690510	1,6	3,12	10
1690515	2,1	3,72	10

Per informazioni tecniche, foto e prezzi aggiornati visita il nostro sito www.cillisrl.com

CESOIA PER TUBI PVC FINO 42 MM



Articolo	Lmm	€ Listino	
9862303	42	8,00	12

IDROINIETTORE VENTURI



Articolo	Ø	€ Listino	
1880520	3/4"	31,86	1
1880530	1"	39,00	1

KIT VENTURIMETRO



Articolo	Ø	€ Listino	
1880522	3/4"	12,46	1
1880523	1"-1.1/2"	13,54	1

FILTRI IN LINEA 120 MESH



Articolo	Ø	€ Listino	
1550010	3/4"	6,00	40
1550020	1"	6,00	30
1550030	1.1/4"	9,12	10
1550040	1.1/2"	9,12	10
1550050	2"	22,00	10

FILTRO IN LINEA



Articolo	Ø	€ Listino	
1550041	1.1/2"	16,00	40

FILTRO IN LINEA 120 MESH MAXI



Articolo	Ø	€ Listino	
1550075	2"	134,90	4
1550080	3"	124,54	4

FILTRO IN LINEA LAMELLARE



Articolo	Ø	€ Listino	
1550055	2"	35,00	10

FILTRO IN LINEA LAMELLARE



Articolo	Ø	€ Listino	
1550011	3/4"	8,00	40

FILTRO IN LINEA LAMELLARE



Articolo	Ø	€ Listino	
1550045	1.½"	27,00	40

FILTRO IN LINEA 3/4 M 50M



Articolo	Ø	€ Listino	
0180430	3/4"	12,60	40

CARTUCCIA PER FILTRO IN LINEA 120 MESCH



Articolo	Ø	€ Listino	
1550025	3/4"-1"	3,18	40
1550052	1.½"-2"	12,00	10
1550140	Ricambio 120 1.¼"-1.½"	7,30	10

SFIATO DOPPIO EFFETTO



Articolo	Ø	€ Listino	
1550000	2	123,00	1

MASCHIO CON TRONCHETTO



Articolo	Ø	€ Listino	
1850705	60 x 1"	8,40	1
1850710	60 x 1.¼"	8,40	1
1850715	60 x 1.½"	9,30	1
1850720	60 x 2"	9,30	1
1850722	60 x 2 ½"	10,80	1
1850725	80 x 1"	10,50	1
1850730	80 x 1.¼"	13,34	1
1850735	80 x 1.½"	13,34	1
1850740	80 x 2"	13,50	1
1850745	80 x 2 ½"	13,80	1
1850750	80 x 3"	14,00	1
1850755	100 x 2"	19,18	1
1850760	100 x 3"	19,18	1
1850765	100 x 4"	20,40	1

FEMMINA CON TRONCHETTO



Articolo	Ø	€ Listino	
1850805	60 x 1"	13,20	1
1850810	60 x 1.¼"	14,00	1
1850815	60 x 1.½"	14,40	1
1850820	60 x 2"	14,80	1
1850822	60 x 2 ½"	15,10	1
1850825	80 x 1"	17,68	1
1850830	80 x 1.¼"	21,22	1
1850835	80 x 1.½"	21,22	1
1850840	80 x 2"	21,40	1
1850845	80 x 2 ½"	21,66	1
1850850	80 x 3"	22,20	1
1850854	100 x 1"	22,30	1
1850853	100 x 1.¼"	22,30	1
1850852	100 x 1.½"	24,50	1
1850855	100 x 2"	25,10	1
1850860	100 x 3"	26,00	1
1850865	100 x 4"	29,00	1

Per informazioni tecniche, foto e prezzi aggiornati visita il nostro sito www.cillisrl.com

**FEMMINA CON MANICOTTO
FILETTATO ZINCATO**



Articolo	Ø	€ Listino	
1851005	60 x 1"	13,20	1
1851015	60 x 1.½"	13,80	1
1851020	60 x 2"	15,30	1
1851022	60 x 2 ½"	17,41	1
1851025	80 x 1"	19,20	1
1851035	80 x 1.½"	21,60	1
1851040	80 x 2"	21,00	1
1851045	80 x 2 ½"	26,20	1
1851050	80 x 3"	27,60	1
1851112	100 x 1.¼"	25,60	1
1851055	100 x 2"	28,90	1
1851058	100 x 3"	31,40	1
1851062	100 x 4"	42,40	1

**MASCHIO CON MANICOTTO
FILETTATO ZINCATO**



Articolo	Ø	€ Listino	
1850905	60 x 1"	11,44	1
1850910	60 x 1.¼"	11,44	1
1850915	60 x 1.½"	11,50	1
1850920	60 x 2"	11,60	1
1850922	60 x 2 ½"	13,88	1
1850925	80 x 1"	12,70	1
1850940	80 x 2"	14,60	1
1850945	80 x 2 ½"	17,40	1
1850950	80 x 3"	19,00	1
1850952	100 x 1"	21,50	1
1850954	100 x 1/2"	22,00	1
1850955	100 x 2"	22,00	1
1850960	100 x 3"	24,00	1
1850965	100 x 4"	40,50	1

MASCHIO PORTAGOMMA ZINCATO



Articolo	Ø	€ Listino	
1850520	60	7,30	1
1850530	80	10,00	1
1850540	100	16,00	1

FEMMINA PORTAGOMMA ZINCATO



Articolo	Ø	€ Listino	
1850620	60	12,00	1
1850630	80	18,00	1
1850640	100	21,00	1

**MASCHIO RIDOTTO
A PORTAGOMMA ZINCATO**



Articolo	Ø	€ Listino	
1850310	60 x 40	12,00	1
1850320	60 x 50	12,00	1
1850330	80 x 60	13,08	1
1850340	80 x 70	13,00	1
1850350	100 x 80	12,78	1

**FEMMINA RIDOTTO
A PORTAGOMMA ZINCATO**



Articolo	Ø	€ Listino	
1850410	60 x 40	17,00	1
1850420	60 x 50	18,00	1
1850430	80 x 60	19,00	1
1850440	80 x 70	19,50	1
1850450	100 x 80	22,00	1

MASCHIO CON PORTAGOMMA INTERNO



Articolo	Ø	€ Listino	
1852015	60 x 50	10,88	1
1852020	60 x 63	13,60	1
1852035	80 x 63	14,70	1
1852040	80 x 75	15,60	1
1852045	80 x 90	15,30	1
1852065	100 x 110	20,30	1

FEMMINA CON PORTAGOMMA INTERNO



Articolo	Ø	€ Listino	
1852115	60 x 50	17,42	1
1852120	60 x 63	19,00	1
1852135	80 x 63	22,50	1
1852140	80 x 75	23,10	1
1852145	80 x 90	24,00	1
1852160	100 x 90	26,70	1

DERIVAZIONE MASCHIO PER FERTILIZZATORE



Articolo	Ø	€ Listino	
1880611	60 x 2" x 1"	23,80	1
1880610	80 x 3" x 1"	32,80	1

DERIVAZIONE FEMMINA PER FERTILIZZATORE



Articolo	Ø	€ Listino	
1880606	60 x 2" x 1"	25,84	1
1880605	80 x 3" x 1"	30,60	1
1880604	100 x 4" x 1"	44,88	1

TAPPO MASCHIO ZINCATO



Articolo	Ø	€ Listino	
1805260	60	8,86	1
1805280	80	13,70	1
1805300	100	16,32	1

TAPPO FEMMINA ZINCATO



Articolo	Ø	€ Listino	
1805160	60	8,98	1
1805180	80	14,42	1
1805200	100	17,60	1

RIDUZIONE ZINCATA



Articolo	Ø	€ Listino	
1855100	80 x 60	24,30	1
1855106	100 x 60	28,20	1
1855108	100 x 80	29,10	1

MAGGIORAZIONE ZINCATA



Articolo	Ø	€ Listino	
1855115	60 x 80	22,00	1
1855120	60 x 100	25,60	1
1855130	80 x 100	32,10	1

DEVIAZIONE LATERALE CON FEMMINA



Articolo	Ø	€ Listino	
1860210	60-60-60	32,50	1

DEVIAZIONE LATERALE ZINCATA



Articolo	Ø	€ Listino	
1860360	60-60-60	32,50	1
1860380	80-80-80	44,70	1

DERIVAZIONE LATERALE CON MASCHIO ZINCATA



Articolo	Ø	€ Listino	
1860160	60 x 60 x 60	32,80	1
1860180	80 x 80 x 80	41,40	1

CURVA A 90° SFERICA ZINCATA



Articolo	Ø	€ Listino	
1806160	60	27,00	1
1806180	80	38,80	1
1806200	100	53,20	1

BIFORCAZIONE SFERICA ZINCATA A T



Articolo	Ø	€ Listino	
1860500	100-100-100	95,00	1

GUARNIZIONE IN GOMMA



Articolo	Ø	€ Listino	
1803060	60	0,60	50
1803080	80	0,78	50
1803100	100	0,84	50
1803150	150	2,60	50

**KIT PER CISTERNA
CON RACCORDO DA 25 IBC**



Articolo	€ Listino	
1905080	26,00	4

• Cisterna non compresa

**KIT PER CISTERNA
CON RACCORDO DA 30 IBC**



Articolo	€ Listino	
1905085	26,00	4

• Cisterna non compresa

TRONCHETTO FILETTATO MASCHIO LINEA 51



Articolo		€ Listino	
1906400	1/2" x 1/2" x 50 cm	3,82	20
1906405	1/2" x 1/2" x 100 cm	5,72	10
1906410	3/4" x 3/4" x 50 cm	4,28	20
1906415	3/4" x 3/4" x 100 cm	6,64	10
1906420	1" x 1" x 50 cm	5,62	20
1906425	1" x 1" x 100 cm	9,14	10

• Filettatura esterna Gas cilindrico UNI ISO 228/1.
Materiale: Polipropilene (PP). Pressione d'esercizio: 10bar a 20°C.
Temperatura max di esercizio: 100°C. Estremità maschio filettate G1 ISO 7/1

**ADATTATORE FF
XS60X6 PER CISTERNA IBC**



Articolo		€ Listino	
1905060	1"	11,20	10

• Cisterna non compresa

**ADATTATORE FM
XS60X6 PER CISTERNA IBC**



Articolo		€ Listino	
1905065	1"	11,20	10

• Cisterna non compresa

**ADATTATORE PER CISTERNE
FILETTATO IBC**



Articolo		€ Listino	
1906300	FF 1" 1/2 x S60 x 6	10,62	10

• Cisterna non compresa

ADATTATORE PER CISTERNE FILETTATO IBC



Articolo		€ Listino	
1906305	FF 2" x S60 x 6	10,62	10
1906315	FF 2" x S100 x 8	32,10	4

- Cisterna non compresa

ADATTATORE PER CISTERNE FILETTATO IBC



Articolo		€ Listino	
1906310	FM 2" x S75 x 6	19,20	10

- Cisterna non compresa

RACCORDO RAPIDO A INNESTO PER SERBATOIO

Ergonomia: Eccellenti condizioni d'installazione diretta dall'esterno del serbatoio garantendo la sicurezza sul lavoro previsto dalla direttiva 89/391/CEE, specialmente quando ci sono esalazioni tossiche.

Sicurezza di tenuta: il design della guarnizione garantisce la tenuta idraulica a 4 bar, su parete piana o con raggio minimo di 50cm, anche con sollecitazioni applicate pari a 8Nm.

Una sola persona con utensili tradizionali effettua l'installazione in qualsiasi posizione del serbatoio in circa 3 secondi.

Esente da manutenzione.

Garantisce la durata nel tempo grazie all'ottima resistenza alla corrosione in qualsiasi ambiente.

- Cisterna non compresa



Articolo	Ø	€ Listino	
1906350	1/2"	7,96	20
1906355	3/4"	8,28	20
1906360	1"	8,44	20
1906365	1.¼"	11,64	10
1906370	1.½"	12,92	10
1906375	2"	14,64	10

ISTRUZIONI PER IL MONTAGGIO

A) Eseguire un foro fig.1 di diametro pari a quello del raccordo, come riportato nell'etichetta del prodotto.

B) Carteggiare con carta abrasiva per eliminare eventuali trucioli e/o spigoli taglienti, sia internamente che esternamente al foro.

C) Inserire il raccordo dall'esterno fig.2, senza smontarlo e posizionarlo come fig.3.

D) Mantenendo il raccordo in battuta come in fig.3, avvitare il dado fino al completo serraggio.

E) La parete deve essere sufficientemente rigida.

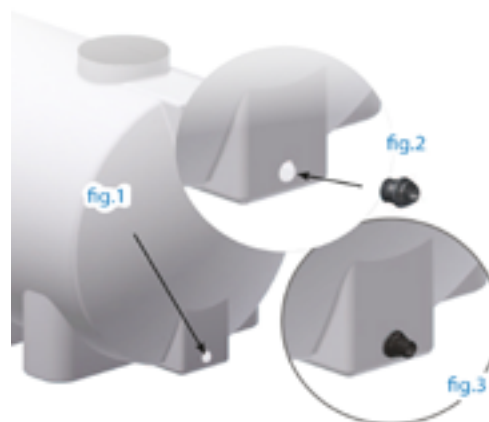

RACCORDO PORTAGOMMA



Articolo	Ø	€ Listino	
1905105	20 x 3/4"	0,56	100
1905108	20 x 1"	0,62	100
1905110	25 x 1"	0,66	100
1905115	30 x 1"	0,78	50
1905118	30 x 1.¼"	0,99	50
1905120	35 x 1.¼"	1,05	50
1905125	40 x 1.½"	1,40	50
1905130	50 x 2"	1,86	50
1905135	60 x 2"	2,40	20

RACCORDI 3 PEZZI DRITTO NYLON



Articolo	Ø	€ Listino	
1901103	20 x 3/4"	1,62	100
1901105	20 x 1"	1,68	100
1901110	25 x 1"	1,77	100
1901115	30 x 1"	2,04	50
1901118	30 x 1.¼"	2,41	50
1901120	35 x 1.¼"	2,72	50
1901122	40 x 1.¼"	2,93	50
1901125	40 x 1.½"	2,93	50
1901128	50 x 1.½"	4,32	50
1901135	50 x 2"	4,51	30
1901138	60 x 2"	5,54	30

GIUNTI 3 PEZZI NYLON



Articolo	Ø	€ Listino	
1908120	20 x 20	1,59	100
1908125	25 x 25	1,70	100
1908130	30 x 30	2,08	50
1908135	35 x 35	2,49	50
1908140	40 x 40	2,70	50
1908150	50 x 50	4,58	50
1908160	60 x 60	5,85	50

RACCORDI NYLON DRITTO



Articolo	Ø	€ Listino	
1905150	20 x 3/4"	0,95	100



Per informazioni tecniche, foto e prezzi aggiornati visita il nostro sito www.cillisrl.com

RACCORDI 3 PEZZI CURVO NYLON



Articolo	Ø	€ Listino	
1902103	20 x 3/4"	1,88	100
1902105	20 x 1"	1,90	100
1902110	25 x 1"	2,26	50
1902115	30 x 1"	2,80	50
1902120	30 x 1.¼"	3,34	50
1902122	40 x 1.¼"	4,06	50
1902125	40 x 1.½"	4,06	50
1902128	50 x 1.½"	5,70	30
1902135	50 x 2"	6,08	30

RACCORDO CURVO 90° MASCHIO PORTAGOMMA



Articolo	Ø	€ Listino	
1905226	20 x 3/4"	0,89	100

RACCORDO DRITTO MASCHIO PORTAGOMMA CON SEDE O-RING



Articolo	Ø	€ Listino	
1905216	20 x 3/4"	0,95	100

RACCORDI NYLON CURVO



Articolo	Ø	€ Listino	
1905160	20 x 3/4"	1,47	100

RACCORDI PORTAGOMMA 90° CON GHIERA E GUARNIZIONE EPDM



Articolo	Ø	€ Listino	
1905180	22 x 1"	1,63	100

RACCORDI 3 PEZZI DRITTO NYLON



Articolo	Ø	€ Listino	
1908210	12 mm	0,64	50
1908220	14 mm	0,82	50
1908230	16 mm	0,84	25
1908240	18 mm	0,86	25
1908250	20 mm	0,89	25
1908260	22 mm	1,16	25
1908270	25 mm	1,30	25
1908280	30 mm	1,46	25
1908290	35 mm	1,96	25
1908300	40 mm	2,06	25

RACCORDI 3 PEZZI CONICO NYLON



Articolo	Ø	€ Listino	
1908310	14 - 16 - 18 mm	0,88	25
1908320	20 - 22 - 25 mm	1,10	25

LANCIA 3/4" GRANDE PORTATA RAPIDA



Articolo	€ Listino	
1936180	10,00	12

RACCORDI RAPIDO OTTONE



Articolo	Ø	€ Listino	
1936121	13	3,52	10
1936123	15	3,56	10
1936126	18	3,58	10
1936129	20	3,60	10
1936132	25	4,00	10
1936135	32	5,38	10
1936138	38	8,14	10

RACCORDO RAPIDO MASCHIO OTTONE

Articolo	Ø	€ Listino	
1936148	3/8"	3,22	10
1936149	1/2"	3,34	10
1936150	3/4"	3,38	10
1936151	1"	3,46	10
1936152	1.¼"	4,84	10
1936153	1.½"	5,44	10



RACCORDO RAPIDO FEMMINA OTTONE

Articolo	Ø	€ Listino	
1936156	1/2"	3,16	10
1936157	3/4"	3,36	10
1936158	1"	3,54	10
1936159	1.¼"	5,28	10
1936160	1.½"	5,70	10



TAPPO RAPIDO CHIUSO OTTONE

Articolo	€ Listino	
1936190	3,04	10



GUARNIZIONE RACCORDO RAPIDO OTTONE

Articolo	€ Listino	
1936165	0,50	50



RACCORDO STOP OTTONE BLISTER

Articolo	Ø	€ Listino	
9203350	1/2"	5,25	24



Per informazioni tecniche, foto e prezzi aggiornati visita il nostro sito www.cillisrl.com

RACCORDO RAPIDO OTTONE BLISTER



Articolo	Ø	€ Listino	
9203310	3/4"	4,50	24

RACCORDO STOP OTTONE BLISTER



Articolo	Ø	€ Listino	
9203360	3/4"	6,50	24

RACCORDO RIPARATORE



Articolo	Ø	€ Listino	
9203600	1/2"	3,72	24

RACCORDO RAPIDO DI GIUNZIONE



Articolo	€ Listino	
9203400	1,92	24

ADATTATORE FEMMINA OTTONE



Articolo	Ø	€ Listino	
9204115	1/2"	1,50	24

GIUNTO RIPARATORE IN BLISTER



Articolo	Ø	Lmm	€ Listino	
9100300	1/2"	12-15	0,70	240
9100310	3/4"	19	1,00	240

RACCORDO PORTAGOMMA 12-15 MM IN BLISTER



Articolo	Ø	€ Listino	
9100200	1/2"	1,00	240

RACCORDO PORTAGOMMA 12-15 MM ACQUASTOP IN BLISTER



Articolo	Ø	€ Listino	
9100210	1/2"	1,10	240

RACCORDO PORTAGOMMA IN BLISTER



Articolo	Ø	€ Listino	
9213020	1/2"	1,41	240

RACCORDO PORTAGOMMA 19 MM IN BLISTER



Articolo	Ø	€ Listino	
9100250	3/4"	1,10	240

RACCORDO UNIVERSALE SFUSO CON CARD



Articolo	Ø	€ Listino	
9215036	1/2" 5/8" 3/4"	3,54	60

RACCORDO UNIVERSALE SFUSO CON CARD



Articolo	Ø	€ Listino	
9215039	1/2" 5/8"	2,54	60

GIUNTO RIPARATORE UNIVERSALE SFUSO CON CARD



Articolo	Ø	€ Listino	
9215042	1/2" 5/8" 3/4"	2,66	40

PRESA RUBINETTI SFUSO CON CARD



Articolo	Ø	€ Listino	
9215030	1"	1,26	70

PRESA RUBINETTI SFUSO CON CARD



Articolo	Ø	€ Listino	
9215033	1/2" 3/4"	1,74	70

RACCORDO PORTAGOMMA 19 MM STOP IN BLISTER



Articolo	Ø	€ Listino	
9100260	3/4"	1,20	240

RACCORDO PORTAGOMMA LUX RIVESTITO IN GOMMA

Articolo	Ø	€ Listino	
9081000	1/2"	2,50	20

Dotata di ghiera in metallo ed impreziosito da un morbido rivestimento in gomma.

RACCORDO PORTAGOMMA ACQUASTOP LUX RIVESTITO IN GOMMA

Dotata di ghiera in metallo ed impreziosito da un morbido rivestimento in gomma.

Articolo	Ø	€ Listino	
9083000	1/2"	2,50	25



Per informazioni tecniche, foto e prezzi aggiornati visita il nostro sito www.cillisrl.com

**PRESA RUBINETTO
IN BLISTER**



Articolo	Ø	€ Listino	
9218502	1"	1,26	240

**PRESA RUBINETTI
IN BLISTER**



Articolo	Ø	€ Listino	
9100330	1" 3/4"	1,00	240

**PRESA RUBINETTO
IN BUSTA**



Articolo	Ø	€ Listino	
9213433	3/4"	1,10	240

PRESA RUBINETTI BLISTER



Articolo	Ø	€ Listino	
9213435	1/2" 3/4"	1,00	240

PRESA RUBINETTO BLISTER



Articolo	Ø	€ Listino	
9100320	1/2" 3/4"	0,80	240

**INNESTO MASCHIO
IN BLISTER**



Articolo	Ø	€ Listino	
9100340	3/4"	0,50	240

**GIUNTO MASCHIO 2 VIE
IN BLISTER**



Articolo	€ Listino	
9100270	0,56	240

**GIUNTO MASCHIO 3 VIE
IN BLISTER**



Articolo	€ Listino	
9100280	0,80	240

RUBINETTO 2 VIE ATTACCO IN BLISTER



Articolo	Ø	€ Listino	
9100360	3/4"	3,10	200

KIT LANCIA CON RACCORDI LUX RIVESTITO IN GOMMA TRICOMPONENTE



Articolo	Ø	€ Listino	
9084000	1/2" 3/4"	6,50	20

KIT 4 PEZZI LANCIA + ACCESSORI IN BLISTER

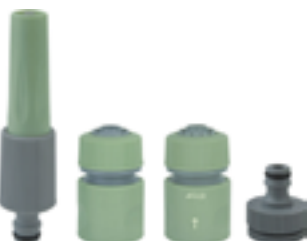

Articolo	Ø	€ Listino	
9111520	1/2"	4,00	80

KIT LANCIA CON RACCORDI IN BLISTER



Articolo	Ø	€ Listino	
9218526	1/2" 3/4"	3,90	96

KIT A 4 PEZZI PISTOLA+RACCORDI



Articolo	€ Listino	
9111530	4,00	40

LANCIA INNAFFIO REGOLABILE IN BLISTER



Articolo	€ Listino	
9100350	1,40	240

LANCIA INNAFFIO OTTONE RIVESTIMENTO IN GOMMA IN BLISTER



Articolo	Ø	€ Listino	
9111810	3/4" F	2,80	24

KIT TUBO CON RACCORDO+LANCIA



Articolo	Lmt	€ Listino	
0661220	8	8,00	12



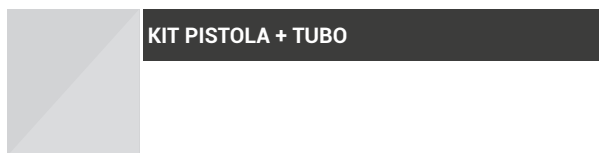

KIT PISTOLA + TUBO

Articolo	Lmt	€ Listino	
0661215	16	19,00	12

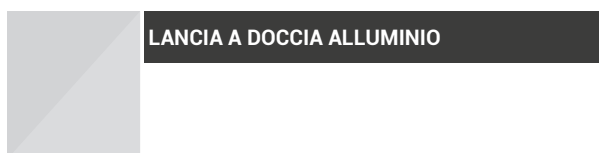

LANCIA A DOCCIA ALLUMINIO



Articolo	€ Listino	
9150145	13,60	12

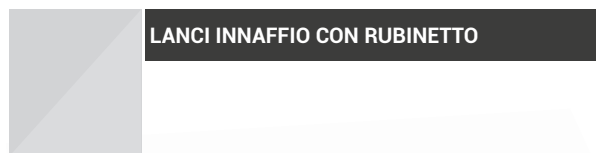

LANCI INNAFFIO CON RUBINETTO



Articolo	Ø	Lmm	€ Listino	
9111700	3/4"	750	8,00	40

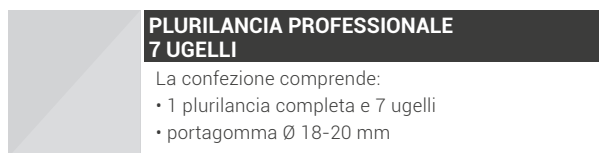

PLURILANCIA PROFESSIONALE 7 UGELLI

- La confezione comprende:
- 1 plurilancia completa e 7 ugelli
 - portagomma Ø 18-20 mm
 - portagomma Ø 21-25 mm



Articolo	Ø	€ Listino	
9205610	3/4" M/F	20,30	6

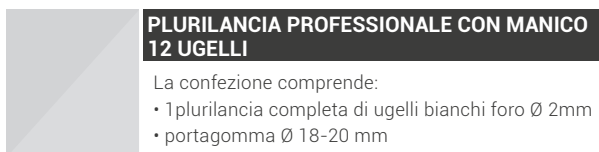

PLURILANCIA PROFESSIONALE CON MANICO 12 UGELLI

- La confezione comprende:
- 1 plurilancia completa di ugelli bianchi foro Ø 2mm
 - portagomma Ø 18-20 mm
 - portagomma Ø 21-25 mm
 - serie ugelli rossi foro Ø 3mm



Articolo	Ø	€ Listino	
9205620	3/4" M/F	36,20	3
9205622	12 Ugelli ricambio	8,40	10

PISTOLA INNAFFIO REGOLABILE PLASTICA

Articolo	€ Listino	
9111555	2,50	60



PISTOLA INNAFFIO OTTONE STANDARD

Articolo	€ Listino	
9111600	6,50	36



PISTOLA INNAFFIO OTTONE PROFESSIONALE

Articolo	€ Listino	
9111580	8,00	36



PISTOLA INNAFFIO REGOLABILE LUX

Articolo	€ Listino	
9111650	9,50	24



PISTOLA INNAFFIO PROFESSIONALE METALLO REGOLABILE

Articolo	€ Listino	
9003027	10,00	20



Per informazioni tecniche, foto e prezzi aggiornati visita il nostro sito www.cillisrl.com

**PISTOLA INNAFFIO PROFESSIONALE
METALLO 10 GETTI**



Articolo	€ Listino	
9003025	10,00	40

**IRRIGATORE 3 BRACCIA
SU BASE PLASTICA**



Articolo	€ Listino	
9150590	15,00	20

IRRIGATORE 3 BRACCIA PLASTICA



Articolo	€ Listino	
9150650	5,00	40

**IRRIGATORE BUTTERFLY
A TRE BRACCIA**



Articolo	Ø	€ Listino	
9002000	1/2"	5,00	20

**CARRELLO EUROTANK AVVOLGITUBO
RAPIDO GF**



Articolo	€ Listino	
9215064	24,68	2

CARRELLO AVVOLGITUBO RAPIDO GF



Articolo	€ Listino	
9215060	21,50	4

AVVOLGITUBO CARRELLATO



Articolo	Portata max	€ Listino	
9215718	60 mt	23,00	1

AVVOLGITUBO CARRELLATO GARDENCI IN METALLO



PRO

Articolo	Portata max	€ Listino	
9150400	100 mt	55,00	3

Fornito già semi-montato, necessità di poche viti ed è subito pronto all'uso. Prodotto professionale, si distingue dagli altri perchè cromato e non zincato. Montaggio rapido.

AVVOLGITUBO DA GIARDINO METALLO

CILLI TEK III

PRO

Articolo	Portata max	€ Listino	
9150410	150 mt	138,00	2
9150430	100 mt	132,00	2

Verniciato a fuoco per una maggiore resistenza alla ruggine. Ruote pneumatiche 260x85. Attacchi per tubi da interni da 1/2" ø 12-15-19-25-30mm.



AVVOLGITUBO AUTOMATICO A MURO TUBO 20 MT



Articolo	€ Listino	
9215705	78,60	2

AVVOLGITUBO A MURO COMPLETO TUBO 15 MT



Articolo	€ Listino	
9215723	24,00	4

Avvolgitubo a muro completo di Tubo, Lancia e raccordi.

PORTATUBO A PARETE

Articolo	€ Listino	
9110600	3,00	60



Per informazioni tecniche, foto e prezzi aggiornati visita il nostro sito www.cillisrl.com



Articolo	Rotolo	Bar	€ Listino	
0661010	12,5 mm 1/2" x 15 mt	24	8,80	24
0661020	12,5 mm 1/2" x 50 mt	24	29,30	12
0661025	12,5 mm 1/2" x 25 mt	24	14,70	12
0661028	15 mm 5/8" x 15 mt	24	9,90	24
0661030	15 mm 5/8" x 25 mt	24	17,00	12
0661040	15 mm 5/8" x 50 mt	24	35,40	6
0661050	19 mm 3/4" x 50 mt	21	53,70	6
0661060	19 mm 3/4" x 25 mt	21	26,90	6
0661080	25 mm 1" x 50 mt	21	85,40	4



Tubo in PVC a tre strati per irrigazione e giardinaggio. Anti-alga e anti UV.

Dotato di rinforzo magliato in poliestere ad alta tenacità. Flessibile e maneggevole, è particolarmente resistente allo schiacciamento.



Articolo	Rotolo	Bar	€ Listino	
0660160	15 mm 5/8" x 25 mt	27	22,70	12
0660170	15 mm 5/8" x 50 mt	27	45,30	6
0660180	19 mm 3/4" x 25 mt	24	33,30	6
0660190	19 mm 3/4" x 50 mt	24	66,60	6
0660200	25 mm 1" x 50 mt	24	109,20	6



Tubo in PVC a 5 strati per irrigazione e giardinaggio. Anti-alga e anti UV.

Dotato di rinforzo magliato Anti Torsione in poliestere ad alta tenacità. Fabbricato con materiali di prima scelta, esenti da DOP e metalli pesanti.

Tubo dagli elevati standard qualitativi, evita torsioni e strozzamenti durante l'utilizzo.

Maneggevole, flessibile e resistente allo schiacciamento.



Articolo	Rotolo	Bar	€ Listino	
0660220	30 mm x 25 mt	21	67,84	4



Articolo	Rotolo	€ Listino	
0660106	15 mm 5/8 x 15 mt	7,40	38



Articolo	Rotolo	€ Listino	
0660100	12,5 mm 1/2" x 15 mt	7,30	38
0660105	15 mm 5/8" x 15 mt	9,42	38





POMPA PRESA DI FORZA TRATTORE ML20 AUTODESCANTE PTO S/D

Articolo	Ø Raccordi	€ Listino	
6120015	30 mm + 30 mm	200,00	1
6120020	30 mm + 20 mm	179,20	1



POMPA PRESA DI FORZA TRATTORE MLI25 AUTODESCANTE PTO S/D

Articolo	Ø Raccordi	€ Listino	
6120025	30 mm + 20 mm	220,50	1



POMPA PRESA DI FORZA TRATTORE MT300 AUTODESCANTE PTO S/D

Articolo	Ø Raccordi	€ Listino	
6120030	40 mm + 40 mm	347,20	1



POMPA PRESA DI FORZA TRATTORE MT600 AUTODESCANTE PTO S/D

Articolo	Ø Raccordi	€ Listino	
6120032	60 mm + 60 mm	1224,00	1

Caratteristiche tecniche		ML 20	MLI 25	MT 300	MT 600
	Portata max	lt./1'	180	180	280
	Usgall/1'	48	48	74	158
	Bar	25	25	30	10
Pressione max	PSI	365	365	427	145
	Mt	250	250	300	100
Prevalenza max	Feet	820	820	984	328
	Mt	6	6	6	6
Profondità max di autodescamento	Feet	20	20	20	20
	Mt	9	9	9	9
Profondità max di autodescamento con valvola di fondo	Feet	30	30	30	30
Velocità max	Giri-rev.1'	700	700	700	700
		Bisenso	OrarioAl	Bisenso	Bisenso
Senso di rotazione		All directions	clockwise	All directions	All directions
Potenza assorbita max	Kw	4	4	7,5	15
Peso	Kg	10	11	21	22

Le pompe serie ML (6120015 e 6120020) serie MT (6120030 e 6120032) sono pompe autoadescanti a rulli che si applicano direttamente alla presa di forza del trattore o del motocoltivatore, senza l'utilizzo del cardano.

Sono indicate nelle operazioni di lavaggio ad alta pressione, irrorazione, diserbo, travaso di qualsiasi liquido non corrosivo a tubo libero, irrigazioni di modeste portate con o senza irrigatori, anche in presenza di terreni con alti dislivelli.

Tutti i modelli sono forniti di una catena per l'ancoraggio ad un punto fisso del trattore. Il modello "MLI 25" (6120025) è dotato di valvola di regolazione della pressione in ottone. Per l'applicazione sui motocoltivatori occorre un'apposito adattatore disponibile a richiesta.

Per informazioni tecniche, foto e prezzi aggiornati visita il nostro sito www.cillisrl.com



Articolo	€ Listino	
6120060	63,70	1

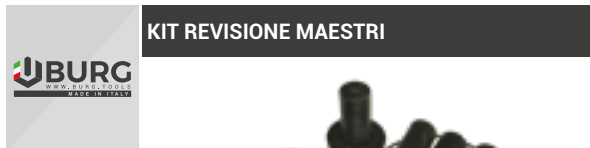

Articolo	€ Listino	
6120062	78,40	1



Articolo	€ Listino	
6120065	83,00	1



Articolo	€ Listino	
6120068	N° 8 esploso 15,60	2

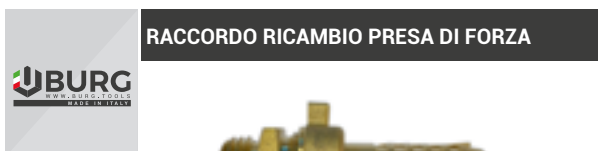

Articolo	Tipo	€ Listino	
6120074	3/4"	12,90	2
6120072	1"	18,14	2



Articolo	Tipo	€ Listino	
6120039	3/4"	4,30	2
6120038	1"	6,60	2

Ricambio per: 6120015-6120020-6120025



Articolo	€ Listino	
6120026	5,00	1



Articolo	€ Listino	
6120050	145,00	1

BURG
www.burg.tools

MOTOPOMPA AUTOADESCANTE 1,5 HP



Articolo		€ Listino	
6100685		215,00	1
RMP00005	Guarnizione	4,00	1
RMP00009	Premistoppe	8,00	1
RMP10016	Kit avviamento	22,60	1
RD00069	Carburatore	55,00	1
RD00030A	Bobina	23,60	1

CARATTERISTICHE

Motore	2 tempi
Potenza	1,5 Hp
Cilindrata	42,73 cc
Diametro ingresso	25 mm
Diametro uscita	25 mm
Portata	7m ³ /h
Prevalenza	22 mt
Aspirazione max	7 mt
Peso	9 Kg
Carburante	Miscela 4%

BURG
www.burg.tools

MOTOPOMPA AUTOADESCANTE 5,5 HP



Articolo		€ Listino	
6100700		278,00	1
6100701	Premistop + OR e ceramica	23,00	1
6100702	Coperchio flangia	14,62	1
6100703	Flangia	43,58	1
6100704	OR per flangia	1,55	1

CARATTERISTICHE

Motore	4 tempi
Potenza	5,5 Hp
Cilindrata	163 cc
Diametro ingresso	50 mm
Diametro uscita	50 mm
Portata	27m ³ /h
Prevalenza	30 mt
Aspirazione max	7 mt
Peso	30 Kg
Carburante	Benzina

BURG
www.burg.toolsPRESSION CONTROLL 1"
GIALLO - PRO-CONTROLL BURG

Articolo		€ Listino	
6100100		40,00	12

CARATTERISTICHE

Pressione max d'esercizio	10 Bar
Taratura d'accensione standard	1,5 Bar
Temperatura massima del liquido	55°C
Tensione di alimentazione	230 V - 50-60 Hz
Intensità max di corrente	10 A
Grado di protezione	IP 54

SCHEDA RICAMBIO PER PRESSION CONTROLL
GIALLO PRO-CONTROLL

Articolo		€ Listino	
6100102	Scheda elettronica	18,00	12

Ricambio per: 6100100

MEMBRANA PRESSION PER PRO-CONTROLL



Articolo		€ Listino	
6100103	Membrana	8,00	12

Ricambio per: 6100100



PRESSION CONTROLL 1" ROSSO - ROHS



PRO

Articolo	€ Listino	
6100105	44,00	12

CARATTERISTICHE

Pressione max d'esercizio	10 Bar
Taratura d'accensione standard	1,5 Bar
Temperatura massima del liquido	45°C
Tensione di alimentazione	230 V - 50 Hz
Intensità max di corrente	10 A
Grado di protezione	IP 55

SCHEDA RHOS PRESSION CONTROLL 1"

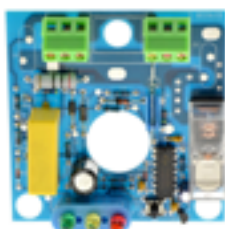

Articolo	€ Listino	
6100106 Scheda elettronica	18,70	12

Ricambio per: 6100105

MEMBRANA PRESSION CONTROLL 1"



Articolo	€ Listino	
6100107 Membrana	9,20	12

Ricambio per: 6100105

ELETTROPOMPA PERIFERICA



6100910-20



6100905

CARATTERISTICHE

Motore	Elettrico monofase
Numero giri motore (rpm)	2850
Portata massima (l/min) 0,5	36
Portata massima (l/min) 0,7	50
Portata massima (l/min) 1	60
Prevalenza massima (mt) 0,5	35
Prevalenza massima (mt) 0,7	44
Prevalenza massima (mt) 1	53
Servizio	Continuo
Protezione termica	Si
Isolamento elettrico	Classe B
Protezione	IP 44
Dimensione attacchi (pollici)	1"
Dimensioni ingombro 0,5	15 x 27,5 x 17 h cm
Dimensioni ingombro 0,7 - 1	17 x 34 x 20 h cm
Prevalenza H (m) 0,37 kW	40,33,23,14,4
Prevalenza H (m) 0,55 kW	60,52,42,35,22,12
Prevalenza H (m) 0,75 kW	70,61,51,41,31,22
Portata Lt/min	0,10,20,30,40,50,60,70

Articolo	kW	Hp	€ Listino	
6100905	0,37	0,50	66,65	6
6100910	0,55	0,70	110,00	6
6100920	0,75	1,00	120,00	6

**ELETTROPOMPA JETS -100S
1,0 HP AUTOADESCANTE**



Articolo	kW	€ Listino	
6100730	0,75	140,00	6

CARATTERISTICHE

Modello	Jets-100S
Applicazione	Acque chiare
Motore	Elettrico
Potenza kW	0,75
Potenza Watt	750
Potenza Hp	1
Tensione Volt	230
Frequenza Hz	50
Numero giri motore	2850 rpm
Attacco	1"
Prevalenza H (m)	50,45,41,37,33,30,27,25,22
Portata Lt/min	5,10,15,20,25,30,35,40,50
Altezza aspirazione	7 metri max

**ELETTROPOMPA SOMMERSA ACQUE CHIARE
HP 1.0-220V-750W**



Articolo	€ Listino	
6101750	277,00	1

CARATTERISTICHE

Applicazione	per acque chiare.
Corpo	in acciaio inossidabile.
Struttura interna motore	in acciaio inox.
Potenza	750 W
H.max	27 m-38 m-50 m
Prevalenza	25L/min-16.6L/min.-8.3L/min.
Portata	3500 lt/h
Alimentazione	220 V
1.0HP	0,75 kw 2850 r/min.
Cavo in dotazione	da 15 mt modello
Scatola comando	in dotazione

**ELETTROPOMPA SOMMERSA ACQUE CHIARE
HP 1,5-220V-1100W**



Articolo	€ Listino	
6101850	365,00	1

CARATTERISTICHE

Applicazione	per acque chiare.
Corpo	in acciaio inossidabile.
Struttura interna motore	in acciaio inox.
Potenza	1100 W
H.max	35m - 65m - 85m
Prevalenza	70L/min. - 50L/min. - 20L/min
Portata	10.000 lt/h
Alimentazione	220/240 V - 50 Hz
1.5HP	1,1 kw 2850 r/min.
Scatola comando	in dotazione

**COPNTROLLER ELETTROPOMPA
S. HP 1-220V**



Articolo	€ Listino	
6101755	42,00	1

COPNTROLLER ELETTROPOMPA S. HP 1.5



Articolo	€ Listino	
6101860	46,00	1

Per informazioni tecniche, foto e prezzi aggiornati visita il nostro sito www.cillisrl.com



**POMPA 25mm YACHT
4,2 mc/h-4ml**



CARATTERISTICHE 6102150	
Diametro	25"(1")
Volume di erogazione	70 l/min: 18,5 U.S.G./min
Prevalenza	4 mt
Temperatura dell'acqua	0°C-60°C
Potenza	DC-24V
Voltaggio	2,5A
Corrente	continua
Potenza motore	45W/5400 rpm
Peso	1,3 Kg

CARATTERISTICHE 6102100	
Diametro	25"(1")
Volume di erogazione	70 l/min: 18,5 U.S.G./min
Prevalenza	4 mt
Temperatura dell'acqua	0°C-60°C
Potenza	DC-12V
Voltaggio	5,4A
Corrente	continua
Potenza motore	45W/5400 rpm
Peso	1,3 Kg

Articolo	Volt	€ Listino	
6102150	24	40,00	10
6102100	12	40,00	10

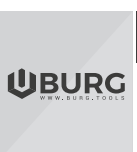
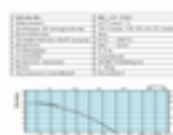

**ELETTROPOMPA SOMMERSA
ACQUE CHIARE**

Articolo	€ Listino	
6102250	60,00	4

CARATTERISTICHE

Potenza	250 W
L/h	5000
Temperatura massima del liquido	35°C
Tensione di alimentazione	230 V - 50Hz
Max profondità di immersione	6 mt

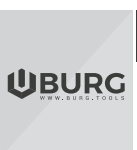

**ELETTROPOMPA SOMMERSA
ACQUE SPORCHE**

Articolo	€ Listino	
6102700	75,00	4

CARATTERISTICHE

Potenza	750 W
L/h	13'000
Temperatura massima del liquido	35°C
Tensione di alimentazione	230 V - 50Hz
Max profondità di immersione	9 mt



**ELETTROPOMPA INOX
ACQUE SPORCHE**

Articolo	€ Listino	
6102750	130,00	4

CARATTERISTICHE

Potenza	1100 W
L/h	16'500
Temperatura massima del liquido	35°C
Tensione di alimentazione	230 V - 50Hz
Max profondità di immersione	9,5 mt



PORTAGOMMA DRITTO MASCHIO GRADINATO



Articolo		€ Listino	
1906450	3/4" x 25 x 19 x 13	0,95	100
1906455	3/4" x 25 x 20 x 13	0,99	100

POMPA PER FONTANA



Articolo		€ Listino	
6101350		55,00	6

CARATTERISTICHE

Potenza	40 W
Altezza max	2,2 mt
Portata max	1800 l/h
Tensione di alimentazione	230 V - 50Hz
Cavo alimentazione	10 mt

• 5 differenti getti inclusi



KIT VASI - CAROTINE GIALLO UNIFLEX



Articolo		€ Listino	
U830116		2,30	8

Kit contenente 2 irrigatori in terracotta ed un contenitore d'acqua da 500 ml, che garantiscono un'autonomia media di 10 giorni, da appendere al bordo del vaso.

KIT VASI - CAROTIN TERRACOTTA UNIFLEX



Articolo		€ Listino	
U830226		2,30	8

Kit contenente 2 irrigatori in terracotta ed un contenitore d'acqua da 500 ml, che garantiscono un'autonomia media di 10 giorni, da appendere al bordo del vaso.

KIT VASI - CAROTINE VERDE UNIFLEX



Articolo		€ Listino	
U830206		2,30	8

Kit contenente 2 irrigatori in terracotta ed un contenitore d'acqua da 500 ml, che garantiscono un'autonomia media di 10 giorni, da appendere al bordo del vaso.

KIT VASI - CAROTINE ANTRACITE UNIFLEX



Articolo		€ Listino	
U830236		2,30	8

Kit contenente 2 irrigatori in terracotta ed un contenitore d'acqua da 500 ml, che garantiscono un'autonomia media di 10 giorni, da appendere al bordo del vaso.

Per informazioni tecniche, foto e prezzi aggiornati visita il nostro sito www.cillisrl.com

Uniflex

**DISPENDER 24 KIT - CAROTINE
4 COLORI UNIFLEX**



Articolo	€ Listino	
U629514	148,00	1

**KIT IRRIGAZIONE
2 PEZZI CON PESCAGGIO**

Contiene 2 irrigatori che irrigano le piante assorbendo l'acqua autonomamente per osmosi. Indicato per piante di appartamento e uso interno in genere, non viene collegato e basta un recipiente che contenga l'acqua.



Articolo	€ Listino	
9159005	1,00	72

**KIT IRRIGAZIONE
2 PEZZI PORTABOTTIGLIE**

Per innaffiare tutte le piante quando non ci sei! L'irrigatore universale si adatta a tutte le bottiglie in plastica, su cui si avvita. Fornisce lentamente, per caduta, tutta l'acqua contenuta nella bottiglia in plastica su cui è inserito. Indispensabile in estate, ideale tutto l'anno!



Articolo	€ Listino	
9159006	2,00	72

UBURG

KIT IRRIGAZIONE 74 PEZZI



Articolo	€ Listino	
9159000	11,40	20

Il kit può essere utilizzato negli orti, nei giardini, nei balconi



RACCOLTA OLIVE



ABBACCHIATORE B-140 CON ASTA Abbacchiatore Elettrico



- Compreso di asta telescopica
- Pettine di ricambio in dotazione



- Fusibile di protezione

Articolo	€ Listino	
9700280	300,00	1

CARATTERISTICHE TECNICHE

Fonte di alimentazione	Batteria	Potenza	140 W
Voltaggio	DC 12V	Vibrazione	9.5 m/s ²
Lunghezza asta	1,9-2,8 mt		
Lunghezza cavo alimentazione	16 mt		
Frequenza dei giri	1000 r/min		

ABBACCHIATORE ELETTRICO PROFESSIONALE "OLIX"

olix



MANINA "WAVE"
ALTA PRODUTTIVITÀ



MANINE
SFALSATE



INTERRUTTORE ON/OFF
SULLA TESTA



CAVO ELETTRICO DA 10 MT IN DOTAZIONE
DA COLLEGARE AD UNA
COMUNE BATTERIA PER AUTOMOBILE
DA 12 VOLT 50/80 AMPERE AL PIOMB
O ALLO ZAINO BATTERIA AL LITIO.



FUSIBILE DI
PROTEZIONE



UTILIZZO
CON ASTA



UTILIZZO
SENZA ASTA



CILLI **TEK** 

"OLIX WAVE" Abbacchiatore Professionale - Elettrico

CILLI TEK



olix
Naturalmente
Tecnologico

- Utilizzabile anche senza asta
- Alta produttività

Articolo	€ Listino	
9701385	348,00	1

BREVETTATO PRO

CARATTERISTICHE TECNICHE			
Potenza	100 Watt	Fusibile sicurezza	10 Ampere
Voltaggio	12 Volt	Lunghezza dente	16,5 cm
Velocità	1.200 batt./min.	Apertura	29 cm
Peso	1.330 gr	Larghezza pettini	26 cm
Lunghezza cavo	10 mt.		

ASTE FISSE E TELESCOPICHE PER ATTREZZI ELETTRICI



Le prolunge fisse e telescopiche CilliTek sono costruite con tubolari in lega di alluminio anodizzato per garantire la protezione alla corrosione. Raccordi in resina termoplastici smontabili. Leggere, resistenti disponibili in tutte le lunghezze anche a richiesta, per soddisfare tutte le esigenze di lavoro.

Presca ad aggancio rapido brevettata per un facile inserimento che permette di utilizzare il pettine sia con l'asta che senza.



ASTA FISSA ELETTRICA OLIX

PRO

Articolo	Lcm	Kg	€ Listino	
9701301	50	0,30	128,00	1
9701302	100	0,40	133,00	1
9701303	150	0,60	140,00	1
9701304	200	0,74	154,00	1
9701305	250	0,85	186,00	1



ASTA TELESCOPICA ELETTRICA OLIX



Sistema di bloccaggio rapido con leva in acciaio per una semplice ed efficace chiusura.

PRO

Articolo	Lcm	Kg	€ Listino	
9701307	120-200	1,10	166,00	1
9701308	150-250	1,30	182,00	1
9701309	180-300	1,45	219,00	1



RICAMBI OLIX

INTERRUTTORE OLIX



Articolo	€ Listino	
9701411	6,50	1

FUSIBILE OLIX



Articolo	€ Listino	
9701407	1,10	1

PORTA FUSIBILE CON COLLEGAMENTO ELETTRICO



Articolo	€ Listino	
9701346	11,00	1

MOTORE SENZA INGRANAGGI OLIX



Articolo	€ Listino	
9701100	100,00	1

RIDUTTORE COMPLETO OLIX



Articolo	€ Listino	
9701373	138,00	1

MOTORE PETTINE CON INGRANAGGI OLIX



Articolo	€ Listino	
9701377	156,00	1

BIELLA OLIX



Articolo	€ Listino	
9701359	28,00	1

CARTER OLIX CON BOCCOLE



Articolo	€ Listino	
9701358 DX	15,50	1
9701360 SX	15,50	1

RICAMBIO COMPLETO MANINA WAVE OLIX



Articolo	€ Listino	
9701386	24,00	1

CAVO ALIMENTAZIONE COMPLETO OLIX



Articolo	Lmt	€ Listino	
9883582	10 mt	94,00	1
9883583	15 mt	118,00	1

Ricambio per abbacchiatori a batteria Olix e Olix Wave.

RICAMBI ABBACCHIATORE OLIX

CILLITEK III

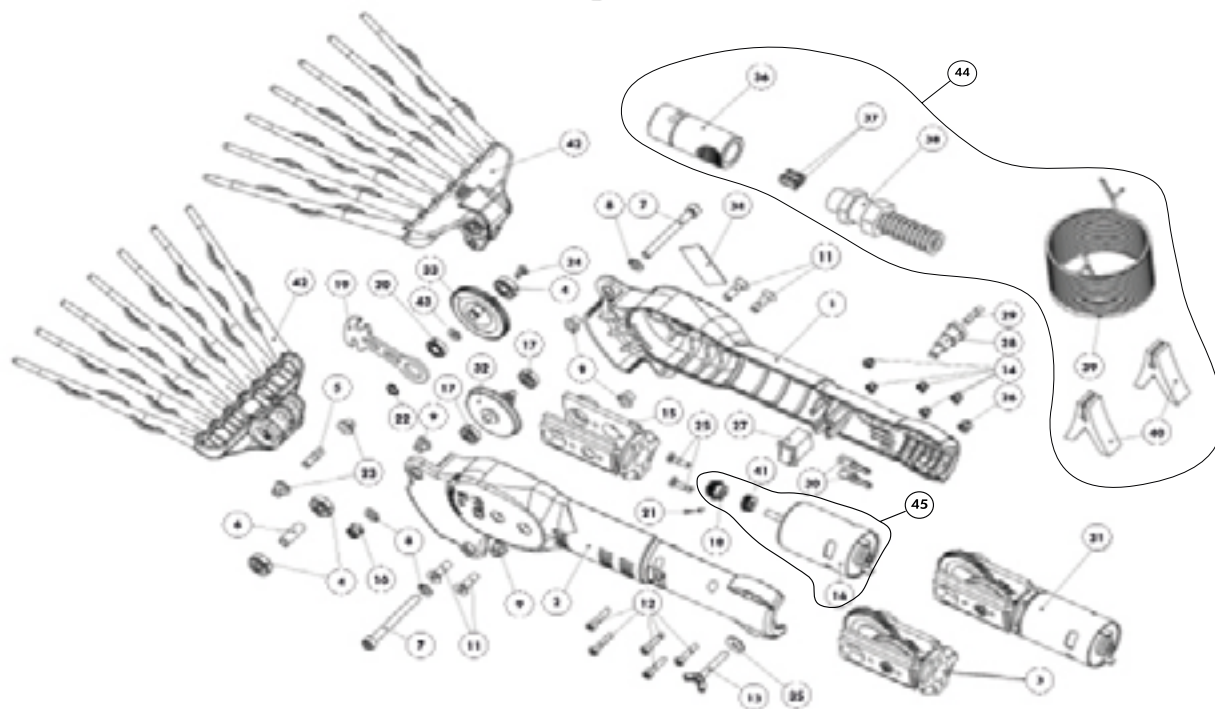

N°	CODICE	DESCRIZIONE	LISTINO	Q.tà	N°	CODICE	DESCRIZIONE	LISTINO	Q.tà
1	9701358	CARTER DX	15,50	1	23	9701368	BOCCOLA SINTETIZZATA	1,48	4
2	9701360	CARTER SX	15,50	1	24	9701443	VITE M4x10	0,20	1
3	9701373	RIDUTTORE COMPLETO OLIX	145,00	1	25	9701406	VITE M4x16	0,50	2
4	9701031	CUSCINETTO A SFERA	2,00	6	26	9701007	DADO AUTOBLOCCANTE M5	0,10	1
5	9701356	SPINOTTO RULLO D6x21	3,12	2	27	9701411	INTERRUTTORE	6,50	1
6	9701032	DISTANZIALE	2,00	2	28	9701408	PORTAFUSIBILE SENZA FILI	8,30	1
7	9701060	VITE TCEI M6x60 ZB	0,84	2	29	9701407	FUSIBILE 12°	1,10	1
8	9701033	RONDELLA FORO TONDO	0,10	4	30	9701456	SPINA MASCHIO	1,00	2
9	9701421	BOCCOLA IN ACCIAIO D12x8x6	1,10	4	31	9701377	MOTORE VL CON INGRANAGGI NEW	156,00	1
10	9701034	DADO AUTOB. M6 BASSO	0,10	2	32	9701445	CORONA DI TRASMISSIONE M1	35,00	1
11	9701420	VITE TSPEI M6x16 ZB	0,20	4	33	9701367	RUOTA DENTATA MOD.1 Z50	30,00	1
12	9701361	VITE TCEI M4x20 ZB	0,10	5	34	9701441	TARGHETTA IDENTIFICATIVA	3,00	1
13	9701362	FARFALLA M5x30 ZB	1,10	1	35	9701444	RONDELLA FORO TONDO	0,08	1
14	9701363	DADO AUTO. ALTO M4	0,18	5	36	9701364	PRESA RAPIDA FEMMINA	7,00	1
15	9701438	SUPPORTO MOTORE RIDUTTORE	60,00	1	37	9701455	SPINA FEMMINA	1,00	2
16	9701435	MOTORE NUDO SENZA PIGNONE	60,00	1	38	9701467	PRESSACAVO ANTIPIEGA	5,00	1
17	9701440	CUSCINETTO 325 ZZ 16x8x5	4,50	2	39	9701470	CAVO NEOPRENE AL MT	6,60	10
18	9701437	PIGNONE CONICO MO.1 Z14	25,00	1	40	9883581	COPPIA MORSETTI	8,00	1
19	9701359	BIELLA	28,00	1	41	9701436	CUSCINETTO REGGISPINTA	3,00	1
20	9701357	CUSCINETTO 624 ZZ 16x8x5	5,60	1	42	9701386	RICAMBIO COMPLETO MANINA	24,00	2
21	9701439	GRANO M3x4	0,10	1	43	9701049	RONDELLA SPESSORE DA 2	3,00	1
22	9701990	SEGER D8 EXT	0,08	1	44	9883582	CAVO COMPLETO 10MT	94,00	1
					45	9701100	KIT MOTORE E PIGNONE	100,00	1

ESPLOSO ASTE FISSE PER ATTREZZI ELETTRICI

CILLI TEK III

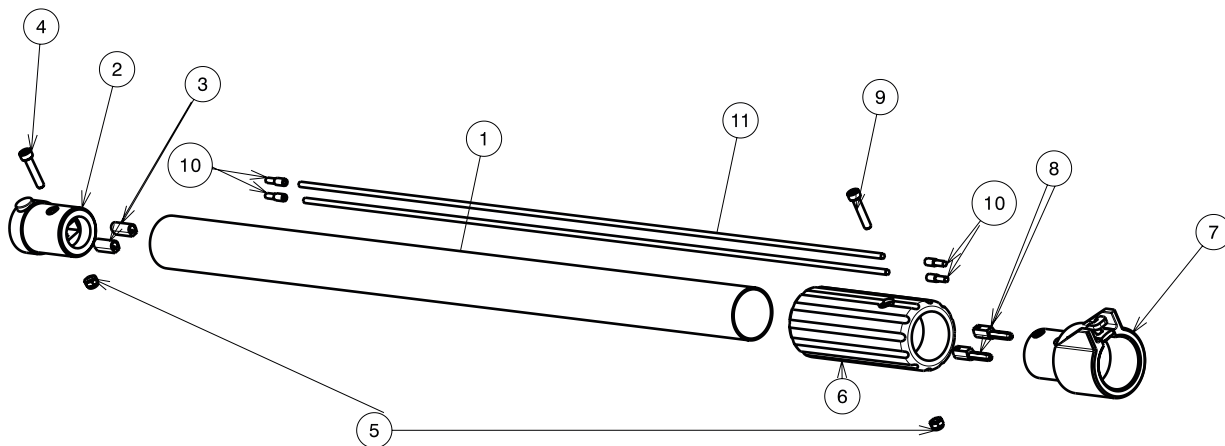

N°	CODICE	DESCRIZIONE	LISTINO	Q.tà
1	0620100	TUBO TONDO ALL.30X1 (SPECIFICARE LUNGHEZZA ASTA)	5,00	ML
2	9701225	PRESA ALIMENTAZIONE MASCHIO	9,00	1
3	9701455	CONNETTORE FEMMINA	1,00	2
4	5303982	VITE VTSEI M4X25	3,00	1
5	9701363	DADO AUTOBLOCCANTE M4	0,18	2
6	9701223	MANOPOLA ASTA D30	4,10	1

N°	CODICE	DESCRIZIONE	LISTINO	Q.tà
7	9701203	ATTACCO RAPIDO FEMMINA	9,00	1
8	9701456	CONNETTORE MASCHIO	1,00	2
9	5303983	VITE TSEI M4X30	3,00	1
10	9701464	TUBETTO PREISOLATO	0,60	4
11	9940000	FILO D2,5 (SPECIFICARE LUNGHEZZA ASTA)	1,57	1ML

ESPLOSO ASTE TELESCOPICHE PER ATTREZZI ELETTRICI

CILLI TEK III

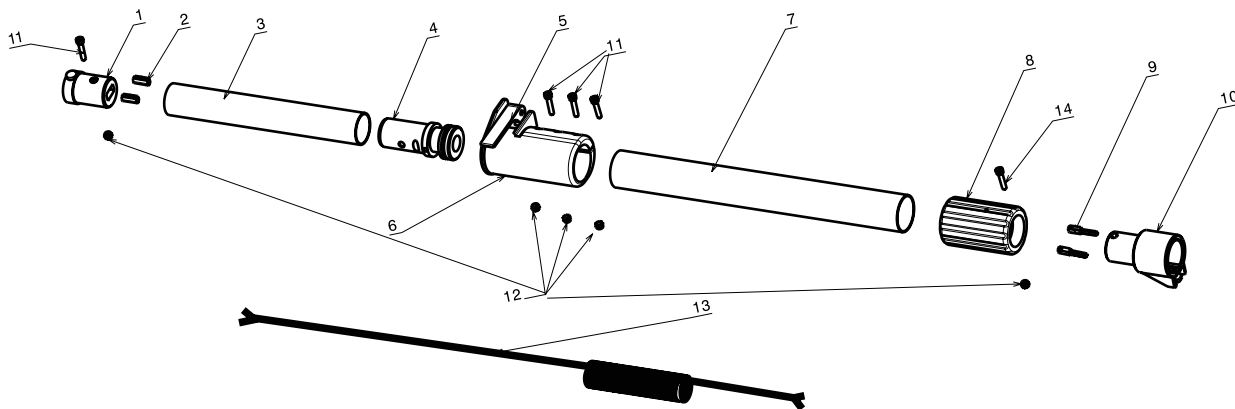

N°	CODICE	DESCRIZIONE	LISTINO	Q.tà
1	9701225	PRESA ALIMENTAZIONE	9,00	1
2	9701455	CONNETTORE FEMMINA	1,00	2
3	0620100	TUBO TONDO ALL.30X1 (SPECIFICARE LUNGHEZZA ASTA)	5,00	ML
4	9701224	PERNO ECCENTRICO PL	4,00	1
5	9701055	LEVA DI BLOCCAGGIO ALLUMINIO	6,00	1
6	9701222	SUPPORTO DI BLOCCAGGIO	6,00	1
7	0620110	TUBO TONDO ALL.35X1 (SPECIFICARE LUNGHEZZA ASTA)	5,56	ML

N°	CODICE	DESCRIZIONE	LISTINO	Q.tà
8	9701226	MANOPOLA	4,40	1
9	9701455	CONNETTORE MASCHIO	1,00	2
10	9701203	ATTACCO RAPIDO FEMMINA	9,00	1
11	5303982	BULLONI TCEI M4X25	3,00	4
12	9701363	DADO M4 AUTOBLOCCANTE	0,18	5
13	9940005	FILO SPIRALATO D2,5X2 1CM	31,60	ML
14	5303983	BULLONE TCEI M4X30	3,00	1

ZAINO Olix BATTERIA AL LITIO BACKPACK LITHIUM BATTERY

MADE IN ITALY

EXTRA LEGGERO
EXTRA LIGHT

SOLO
ONLY
2700 gr.



SCHIENALE E SPALLACCI
COMODI ED ERGONOMICI.
LO ZAINO PUO' ESSERE INDOSSATO PER
MOLTO TEMPO CON LA MASSIMA
COMODITA'

COMFORTABLE AND ERGONOMIC
BACK AND SHOULDER; THE BACKPACK
CAN BE WORN FOR A LONG TIME WITH
THE MAXIMUM COMFORT



CARICABATTERIE
IN DOTAZIONE

CHARGERS SUPPLIED
HIGHER PERFORMANCE THAN
A NORMAL LEAD BATTERY



SPINA RAPIDA
IL CAVO IN DOTAZIONE HA LA
SPINA PREDISPOSTA PER ESSERE
AGGANCIATA RAPIDAMENTE AL
PETTINE O ALL'ASTA Olix

RAPID PLUG
PREPARED TO BE RESTIVELY
FASTED ON THE COMB OR THE
"OLIX" ROD



INDICATORE DI CARICA
PERMETTE DI CONTOLLARE IN
QUALUNQUE MOMENTO LO
STATO DI CARICA

4 HOURS OF CONTINUOUS CYCLE
DURATION



PUO ESSERE UTILIZATO CON
O SENZA ASTA

IT CAN BE USED WITH OR
WITHOUT ROD



CILLITEK

dal 1984 innovazione in campo

since 1984 field innovation

ZAINO Olix LITHIUM BATTERY



Liberi di raccogliere



Il nuovo zaino Olix Battery con batteria al Litio garantisce prestazioni superiori all'abbacchiatore Olix e assicura un altissimo confort di lavoro. La batteria al litio permette ad Olix di raggiungere un numero di battute maggiori rispetto ad una normale batteria al piombo ed assicura una costanza delle prestazioni fino a fine carica. Il tutto con un eccellente confort di lavoro, grazie alla leggerezza della batteria e l'ergonomia dello zainetto, sarete liberi di raccogliere con agilità anche sui terreni più ripidi e scomodi.

Articolo	Batterie	€ Listino	
9701378	1	800,00	1
9701382	2	1500,00	1

CARATTERISTICHE TECNICHE PER SINGOLA BATTERIA

Voltaggio	12 Volt
Durata singola batteria	4 Ore
Peso	2.700 grammi
Ampere	30 Ampere

**ABBACCHIATORE E ASTA NON COMPRESI.
DA ACQUISTARE A PARTE.**



Utilizzo con asta



Utilizzo senza asta

PRO

BATTERIA + CARICABATTERIA RICAMBIO OLIX BATTERY

SOLO BATTERIA E CARICABATTERIA
RICAMBIO, SENZA ZAINO E SENZA CAVO
PER ABBACCHIATORE OLIX CILLITEK



Articolo	€ Listino	
9701376	760,00	2

CAVO RICAMBIO OLIX BATTERY

SOLO BATTERIA E CARICABATTERIA
RICAMBIO, SENZA ZAINO E SENZA CAVO
PER ABBACCHIATORE OLIX CILLITEK



Articolo	€ Listino	
9701375	34,00	2

ZAINO RICAMBIO OLIX BATTERY

SOLO ZAINO RICAMBIO SENZA BATTERIA
PER ABBACCHIATORE OLIX CILLITEK



Articolo	€ Listino	
9701374	60,00	2

ZAINO BATTERIA OLIX AGILIT



IN DOTAZIONE:



Carica batteria



Indicatore di carica



Zaino

Lo zaino AGILIT è dotato di una batteria ai polimeri di litio ad alta efficienza, che permette di alimentare gli abbacchiatori OLIX ed OLIX WAVE. Alimentando gli abbacchiatori con lo zaino AGILIT le prestazioni di OLIX ed OLIX WAVE risultano superiori, in quanto la batteria ai polimeri di litio mantiene la stessa potenza dall'inizio alla fine della carica, al contrario delle batterie normali che perdono di potenza gradualmente durante la fase di scarico.

AGILIT rende la raccolta molto confortevole offrendo la possibilità di avere la batteria di solo 3300 g. nello zaino, con tanti vantaggi:

- possibilità di usare l'abbacchiatore su terreni in pendenza;
- nessun rischio di intreccio cavi, quando si raccoglie con più macchine;
- non si deve spostare il carrello batteria quando il cavo non basta più.

CARATTERISTICHE TECNICHE

Potenza	500 Watt
Voltaggio	12 Volt
Tempo di ricarica	4h circa
Peso	3.300 gr
Vita utile	1200 CICLI minimo
Autonomia	6-7 ore
Batteria tipo	LITHIO/POLIMERI

Articolo	€ Listino	
9702012	1000,00	1

PRO

EXTRA LEGGERO
3300
grammi

Prezzo riferito solo al carrello zincato.



ESEMPI DI APPLICAZIONE



PRO ■ ■

Articolo	€ Listino	
9702000	130,00	1

Carrello in acciaio zincato multiuso, può trasportare pompe per irrorazione, elettropompe, batterie. CON RUOTE ANTIFORO.

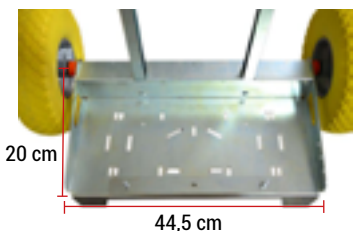

20 cm

44,5 cm

Dimensioni



Gancio portacavo



Ruote antipuntura

BATTERIA AUTO 60AH CASSETTA L2

Batteria senza manutenzione, costruita con lega Pb/Ca con griglia espansa.
Materiale box e coperchio : copolimero di polipropilene.
Colore box: Nero. Colore coperchio: Nero. Piastre imbustate, con materiale polietilenico. Peso per batteria carica approssimativo 13,900 kg. Acido solforico di peso specifico 1,28 +/- 0,01. Temperatura di riferimento per la densità e per le caratteristiche elettriche 25°. Spunto: 540EN. Dimensioni: altezza 190mm, larghezza 242mm, spessore 175mm, dente di aggancio 10,5mm



Articolo	€ Listino		PRO  
9995923	83,80	2	

BATTERIA AUTO 80AH CASSETTA L3

Batteria senza manutenzione, costruita con lega Pb/Ca con griglia espansa.
Materiale box e coperchio : copolimero di polipropilene.
Colore box: Nero. Colore coperchio: Nero. Piastre imbustate, con materiale polietilenico. Peso per batteria carica approssimativo 16,400 kg. Acido solforico di peso specifico 1,28 +/- 0,01. Temperatura di riferimento per la densità e per le caratteristiche elettriche 25°. Spunto: 640EN. Dimensioni: altezza 190mm, larghezza



Articolo	€ Listino		PRO  
9995929	119,20	2	

BATTERIA AUTO 100AH CASSETTA L5

Batteria senza manutenzione, costruita con lega Pb/Ca con griglia espansa.
Materiale box e coperchio : copolimero di polipropilene.
Colore box: Nero. Colore coperchio: Nero. Piastre imbustate, con materiale polietilenico. Peso per batteria carica approssimativo 22,3 kg. Acido solforico di peso specifico 1,28 +/- 0,01. Temperatura di riferimento per la densità e per le caratteristiche elettriche 25°. Spunto: 800EN. Dimensioni: altezza 190mm, larghezza 353mm, spessore 175mm, dente di aggancio 10,5mm



Articolo	€ Listino		PRO  
9995935	147,40	2	

CILLITEK

innovazione in campo



Abbacchiatore Professionale Pneumatico

velocità 2.000 battiti/min - peso 600 gr. - lunghezza dente 16,5 cm - apertura 30 cm
larghezza pettini 26 cm - pressione d'esercizio 6/7 atm. - consumo d'aria 160 l/min.

Grazie al suo peso di solo 600 grammi, rende la raccolta molto più leggera. Non stanca mai !

Prestazioni efficienti anche a bassa pressione.

Grazie alla forma ad onda delle manine "wave", alla loro elasticità e alla disposizione sfalzata, permette di ottenere una raccolta maggiore e staccare, il 100% delle olive,

www.cillitek.com

AIR Abbacchiatore professionale - pneumatico

CILLITEK III

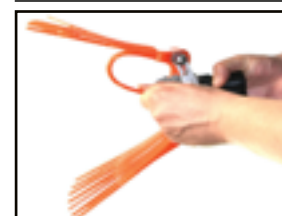

air

600 GRAMMI
DI POTENZA

Air è il nuovo abbacchiatore prodotto da CilliTek che rivoluzionerà la raccolta delle olive e nocchie, grazie alla sua leggerezza e all'incredibile velocità di raccolta.

Il suo funzionamento e la sua incredibile affidabilità renderà la vostra esperienza di raccolta, estremamente confortevole e redditizia. Il peso di solo 600 grammi è un risultato ottenuto grazie all'uso di materiali high-tech, che garantiscono allo scuotitore estrema leggerezza e maneggevolezza, oltre ad un'elevata affidabilità. Inoltre su questo scuotitore è montata la nuova manina "wave" che grazie alla forma ad onda dei suoi denti e la loro elasticità permette di staccare il 100% delle olive indipendentemente dal grado di maturazione e di non arrecare danni ai frutti. Air può essere dotato di aste fisse e telescopiche in lega leggera di alluminio anodizzato da 50 a 400 cm.

Articolo	€ Listino	
0000600	310,00	1

BREVETTATO PRO

CARATTERISTICHE TECNICHE			
Velocità	2.000 batt./min.	Larghezza pettini	26 cm
Peso	600 gr	Pressione d'esercizio	6/7 atm
Lunghezza dente	16,5 cm	Consumo d'aria	160 l/min.
Apertura	30 cm		

RICAMBI ABBACCHIATORE "AIR"

CILLITEK III

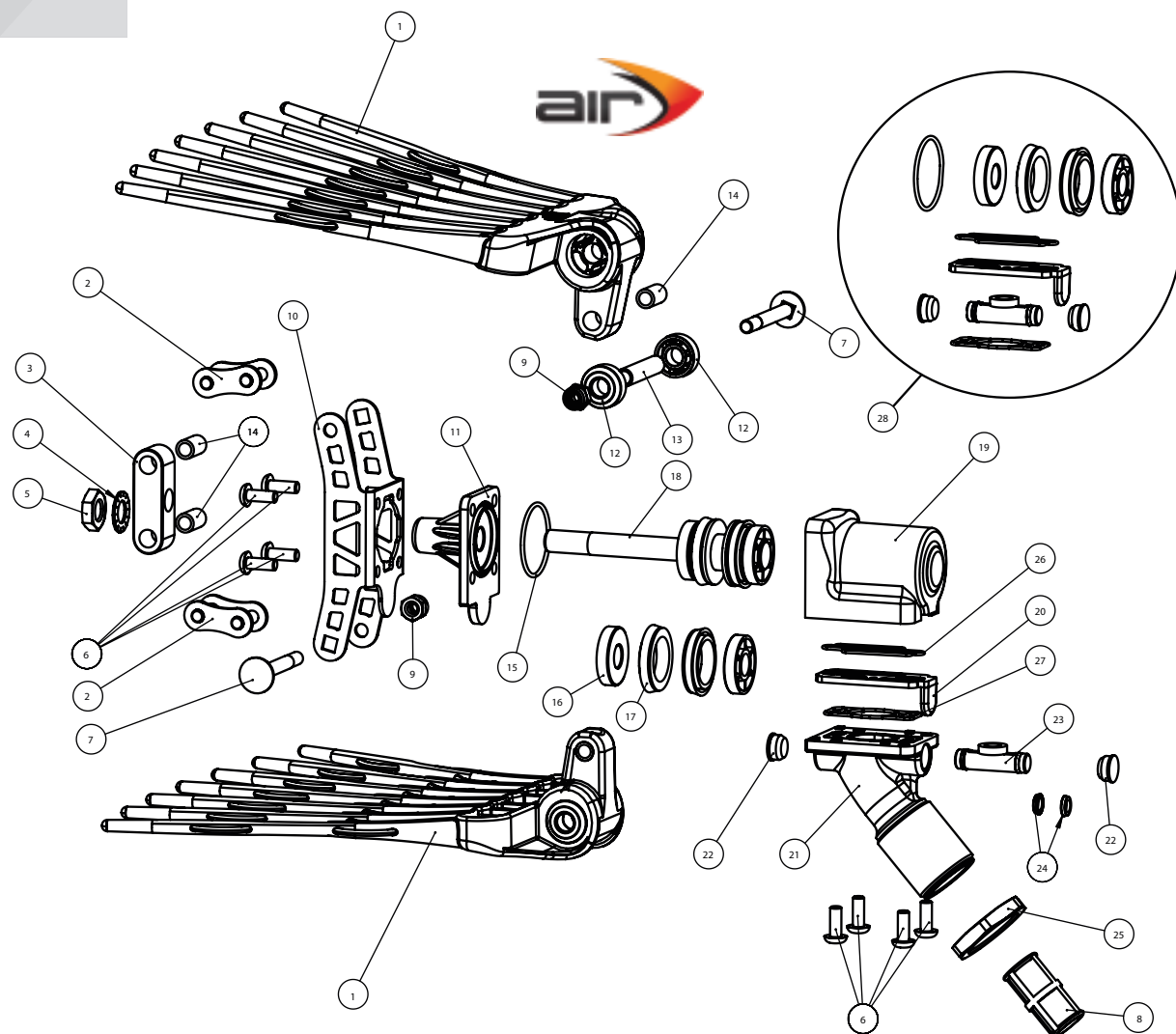

N°	CODICE	DESCRIZIONE	LISTINO	Q.tà	N°	CODICE	DESCRIZIONE	LISTINO	Q.tà
1	9701078	MANINA COMPLETA MAGLIA GIUNZIONE	24,00	2	15	0144100	O-RING COPERCHIO	1,00	1
2	9701026	MAGLIA GIUNZIONE 3/4	2,00	2	16	9701009	PARACOLPI PISTONE	2,00	2
3	9701025	KIT STAFFA GIUNZ. CON BOCCOLA	11,10	1	17	9701010	GUARNIZIONE A LABBRO	2,80	2
4	9701030	RONDELLA ZIGRINATA M10	0,09	1	18	9701028	KIT PISTONE ALBERO COMPLETO	25,00	1
5	9701024	DADO BASSO M19	0,36	1	19	9701995	CORPO CILINDRO	50,00	1
6	9701082	VITI FUNGO/FL. M5x16 ZINC. NERA	0,15	8	20	9701075	PIASTRINA SCAMBIATORE	2,50	1
7	9701029	VITE TESTA TONDA 6x50	4,00	2	21	9701998	CORPO DISTRIBUTORE	40,00	1
8	9701040	FILTRO	2,00	1	22	9701027	GOMMINO AMMORTIZZATORE	1,00	2
9	9701091	DADO AUTOB. M6 ALTO	0,40	2	23	9701045	KIT PIST. SCAMBIATORE COMP.	7,29	1
10	9701067	FORCELLA PETTINE INOX	25,00	1	24	9701048	O-RING	0,55	2
11	9701006	COPERCHIO ANTERIORE	20,00	1	25	9701240	GHIERA DI BLOCCAGGIO	3,00	1
12	9701031	CUSCINETTO A SFERA 626 2Z	2,00	4	26	9701416	O-RING BASE CILINDRO	2,50	1
13	9701032	DISTANZIALE CUSCINETTO 6x8x22	2,00	2	27	9701087	O-RING BASE SCAMBIATORE	2,50	1
14	9701431	BOCCOLA STAFFA GIUNZIONE 3/4	0,80	4	28	9701089	KIT GUARNIZIONI	25,00	1

Q.PRO Abbacchiatore professionale - pneumatico

CILLITEK III



Q.PRO il pettine ad aria CilliTek dall'incredibile affidabilità, grazie alla forma dei suoi denti a "Y" garantisce il distacco di tutti i tipi di frutti, anche i meno maturi e più difficili da far cadere.

Q.PRO consuma poca aria (170/190 l/min.) e mantiene un'elevata velocità anche a bassa pressione.

Q.PRO può essere dotato di aste fisse e telescopiche in lega leggera di alluminio anodizzato da 50 a 400 cm.

Articolo	€ Listino	
9701000	260,00	1

BREVETTATO

PRO



CARATTERISTICHE TECNICHE

Velocità	1.700 batt./min.	Larghezza pettini	26 cm
Peso	1.150 gr	Pressione d'esercizio	6/8 atm
Lunghezza dente	15,5 cm	Consumo d'aria	170/190 l/min.
Apertura	30 cm		

RICAMBI ABBACCHIATORE "Q.PRO, ERNESTO, ERNESTO PLUS"

CILLI TEK III

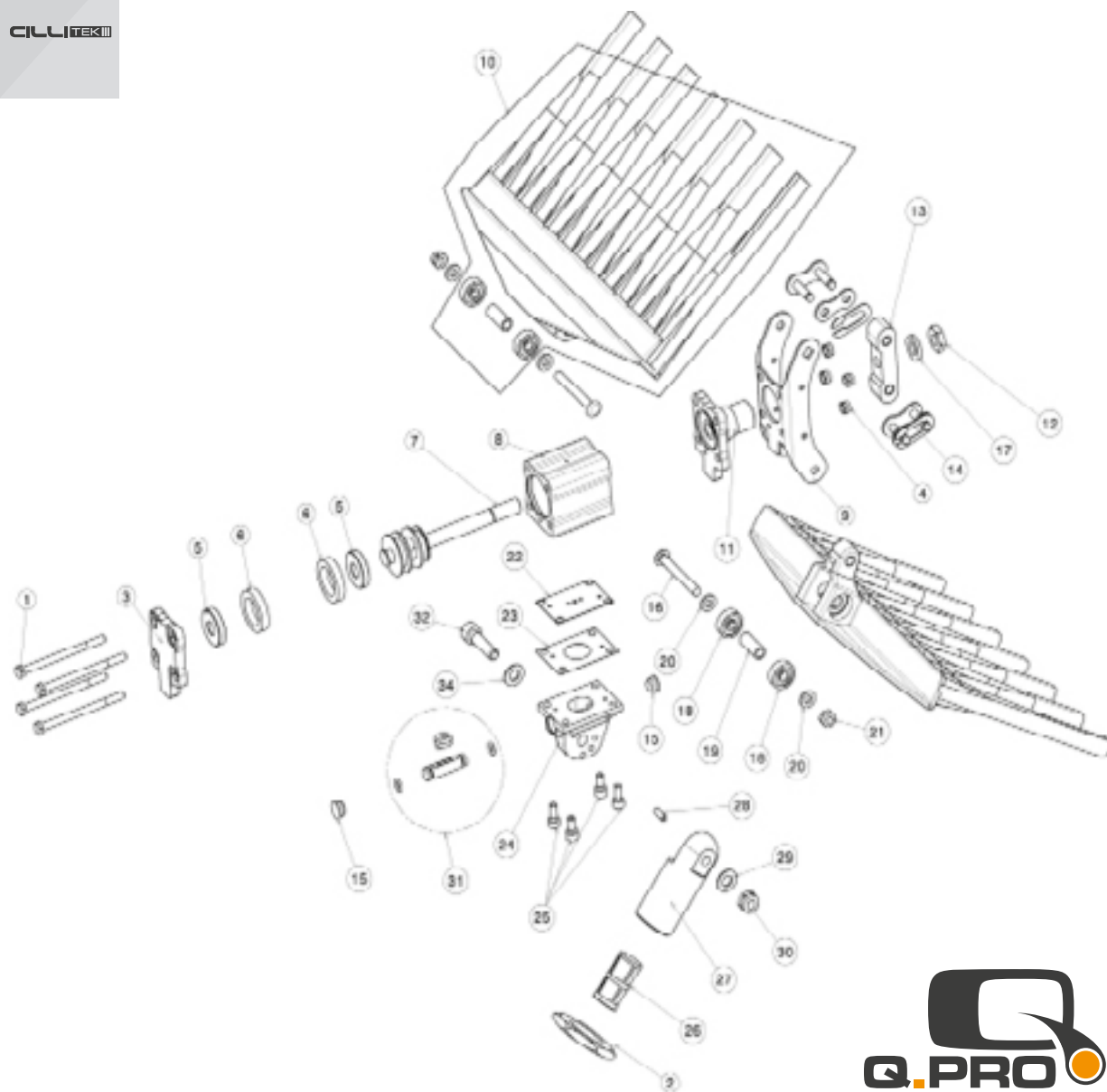

N°	CODICE	DESCRIZIONE	LISTINO	Q.tà	N°	CODICE	DESCRIZIONE	LISTINO	Q.tà
1	9701002	VITE TCEI 5931 ZINC.M5X70	0,43	4	17	9701030	RONDELLA SPACCATA	0,09	1
2	9701215	GHIERA BLOCCAGGIO	3,00	1	18	9701031	CUSCINETTO A SFERA	2,00	4
3	9701004	COPERCHIO POSTERIORE	20,00	1	19	9701032	DISTANZIALE CUSCINETTO	2,00	2
4	9701007	DADO AUTOBLOCCANTE ALTO M5	0,10	4	20	9701033	RONDELLA FORO TONDO	0,10	4
5	9701009	PARACOLPI PISTONE	2,00	2	21	9701034	DADO AUTOBLOCCANTE	0,10	2
6	9701010	GUARNIZIONE A LABBRO	2,80	2	22	9701035	PIASTRINA SCORRIMENTO PAST.	7,00	1
7	9701097	KIT PISTONE ALBERO COMPLETO	25,00	1	23	9701036	GUARNIZIONE DISTRIBUTORE	1,20	1
8	9701013	CORPO CILINDRO	65,00	1	24	9701037	BASE DISTRIBUTORE	46,70	1
9	9701014	FORCELLA PETTINE Q.PRO	26,00	1	25	9701039	VITE TCEI ZINC. M5X12	0,12	4
10	9701001	PETTINE COMPLETO	20,00	2	26	9701040	FILTRO	2,00	1
11	9701023	COPERCHIO ANTERIORE	20,00	1	27	9701041	ATTACCO DISTRIBUTORE	23,80	1
12	9701024	DADO BASSO M10	0,36	1	28	9701042	SPINA CILINDRICA 4X12	2,00	1
13	9701025	STAFFA GIUNZIONE	11,10	1	29	9701043	RONDELLA PIANA D.8	0,20	2
14	9701026	MAGLIA GIUNZIONE	2,00	2	30	9701044	DADO AUTOBLOCCANTE BASSO M8	0,70	1
15	9701027	GOMMINO AMMORTIZZANTE	1,00	2	31	9701045	PISTONCINO SCAMBIO COMPLETO	7,29	1
16	9701029	VITE TESTA TONDA 6X50	4,00	2	32	9701046	VITE 8X40	0,34	1

RICAMBI PNEUMATICO

KIT GUARNIZIONI AIR E BIOCARBON



Articolo	€ Listino	
9701089	25,00	1

KIT GUARNIZIONI Q.PRO ERNESTO, ERNESTO PLUS



Articolo	€ Listino	
9701058	25,00	1

KIT GUARNIZIONI ERNESTO 2000



Articolo	€ Listino	
9701095	25,00	1

RICAMBIO COMPLETO MANINA PNEUMATICA WAVE



Articolo	€ Listino	
9701078	24,00	1

Ricambio adatto ad abbacchiatori pneumatici:
Q.Pro, Ernesto, Ernesto plus, Ernesto - Completo di cuscinetti

KIT RICAMBIO COMPLETO MANINA PNEUMATICA BIGPRO



Articolo	€ Listino	
9701001	20,00	1

Ricambio adatto ad abbacchiatori pneumatici:
Q.Pro, Ernesto, Ernesto plus, Ernesto - Completo di cuscinetti

ASTE FISSE E TELESCOPICHE PER ATTREZZI PNEUMATICI

CILLI TEK III

Le prolunghe fisse e telescopiche CilliTek sono costruite con tubolari in lega di alluminio anodizzato di alta qualità per garantire la protezione alla corrosione.

Raccordi in resina termoplastici smontabili. Leggeri e resistenti per soddisfare tutte le esigenze di lavoro.

Collegabili a tutti gli attrezzi pneumatici che abbiano un filetto maschio e femmina 30x1,5 mm.

Le aste vengono fornite senza impugnatura.

ASTA FISSA PNEUMATICA

CILLI TEK III

PRO 

Articolo	Lcm	Kg	€ Listino	
9700993	50	0,34	53,00	1
9700994	100	0,48	55,00	1
9700995	150	0,64	57,00	1
9700996	200	0,80	63,00	1
9700997	250	0,96	86,00	1



ASTA TELESCOPICA PNEUMATICA

CILLI TEK III



Sistema di bloccaggio rapido con leva in acciaio per una semplice ed efficace chiusura.

PRO 

Articolo	Lcm	Kg	€ Listino	
9700939	70-120	0,90	82,00	1
9700940	100-160	1,00	88,00	1
9700944	120-200	1,20	98,00	1
9700946	140-250	1,40	103,00	1
9700947	170-320	1,60	113,00	1
9700952	200-400	2,00	140,00	1



Per informazioni tecniche, foto e prezzi aggiornati visita il nostro sito www.cillisrl.com



IMPUGNATURA PER ASTA PNEUMATICA

Articolo	€ Listino	
9701200	46,00	1

Impugnatura per asta pneumatica / manico / per raccolta olive, potatura, compatibile con tutti gli utensili ad aria compressa con attacco 30 x 1,5



IMPUGNATURA PER ASTA PNEUMATICA PRO

Articolo	€ Listino	
9701202	58,48	1



**ATTACCO FILETTATO MASCHIO D.30
ASTA FISSA**

Articolo	€ Listino	
9701219	5,30	1

Ricambio per aste: 9700993-9700994-9700995-9700996-9700997-9700998



**MANICOTTO FILETTATO FEM. D.14 ASTA
TELESCOPICA**

Articolo	€ Listino	
9701229	14,80	1

Ricambio per aste telescopiche: 9700939-9700940-9700944-9700946-9700947-9700952



**MANICOTTO FILETTATO FEMMINA D.10
ASTA FISSA**

Articolo	€ Listino	
9701220	14,80	1

Ricambio per aste: 9700993-9700994-9700995-9700996-9700997-9700998



**ATTACCO FILETTATO MASCHIO D.35 ASTA
TELESCOPICA**

Articolo	€ Listino	
9701218	5,50	1

Ricambio per aste telescopiche: 9700939-9700940-9700944-9700946-9700947-9700952



**BLOCCAGGIO ASTA PL ASTA
TELESCOPICA**

Articolo	€ Listino	
9701222	6,00	1

Ricambio per aste telescopiche: 9700939-9700940-9700944-9700946-9700947-9700952



LEVA BLOCCAGGIO ASTA TELESCOPICA

Articolo	€ Listino	
9701055	6,00	1

Ricambio per aste telescopiche: 9700939-9700940-9700944-9700946-9700947-9700952

ASTE FISSE PER ATTREZZI PNEUMATICI

CILLI TEK III

Le prolunghe fisse e telescopiche CilliTek sono costruite con tubolari in lega di alluminio anodizzato per garantire la protezione alla corrosione.

Collegabili a tutti gli attrezzi pneumatici che abbiano un filetto maschio e femmina 30x1,5 mm.



CILLI TEK III

ASTA FISSA PNEUMATICA CON RUBINETTO

PRO

Articolo	Lcm	Kg	€ Listino	
9701233	100	550	63,10	1
9701234	150	750	67,50	1
9701235	200	950	73,90	1
9701236	250	1150	89,80	1



CILLI TEK III

ASTA PNEUMATICA CON RACCORDI FILETTATI

PRO

Articolo	Lcm	Kg	€ Listino	
9701241	100	550	57,00	1
9701242	150	750	59,00	1
9701243	200	950	66,00	1
9701244	250	1150	80,00	1



RICAMBIO ATTACCO RUBINETTO

Articolo	€ Listino	
9701217	21,40	10



RICAMBIO ATTACCO IMPUGNATURA ASTA

Articolo	€ Listino	
9701214	22,00	10



VALVOLA A CORSOIO M-F 1/4"

Articolo	Lcm	€ Listino	
9701209	1/4"	8,00	12



ESEMPI DI APPLICAZIONE ACCESSORI

Accessori da acquistare separatamente

INNESTO RUBINETTO PER ASTA

Articolo	€ Listino	
9701210	21,00	10



MANICOTTO ASTA PER RUBINETTO

Articolo	€ Listino	
9701211	12,70	10

Senza guarnizione



GUARNIZIONI PER ASTA E IMPUGNATURA

Articolo	€ Listino	
9701206	0,72	50

Ø Interno: 20 Spessore: 7 Ø Internal: 20 Thickness: 7
Ø Esterno: 28 NBR: 70 shore Ø Outer: 28 NBR: 70 shore



AVVOLGITUBO ARIA COMPRESSA CON FRENO AUTOMATICO COMPLETO DI RACCORDO DA Ø10

CILLITEK III

Dotato di freno autobloccante a bilanciere brevettato.
Lo svolgimento della bobina avviene mediante una leggera trazione sul tubo.
Al rilascio del tubo si aziona il freno, impedendo lo srotolamento involontario del tubo.
Tamburo e struttura in metallo.

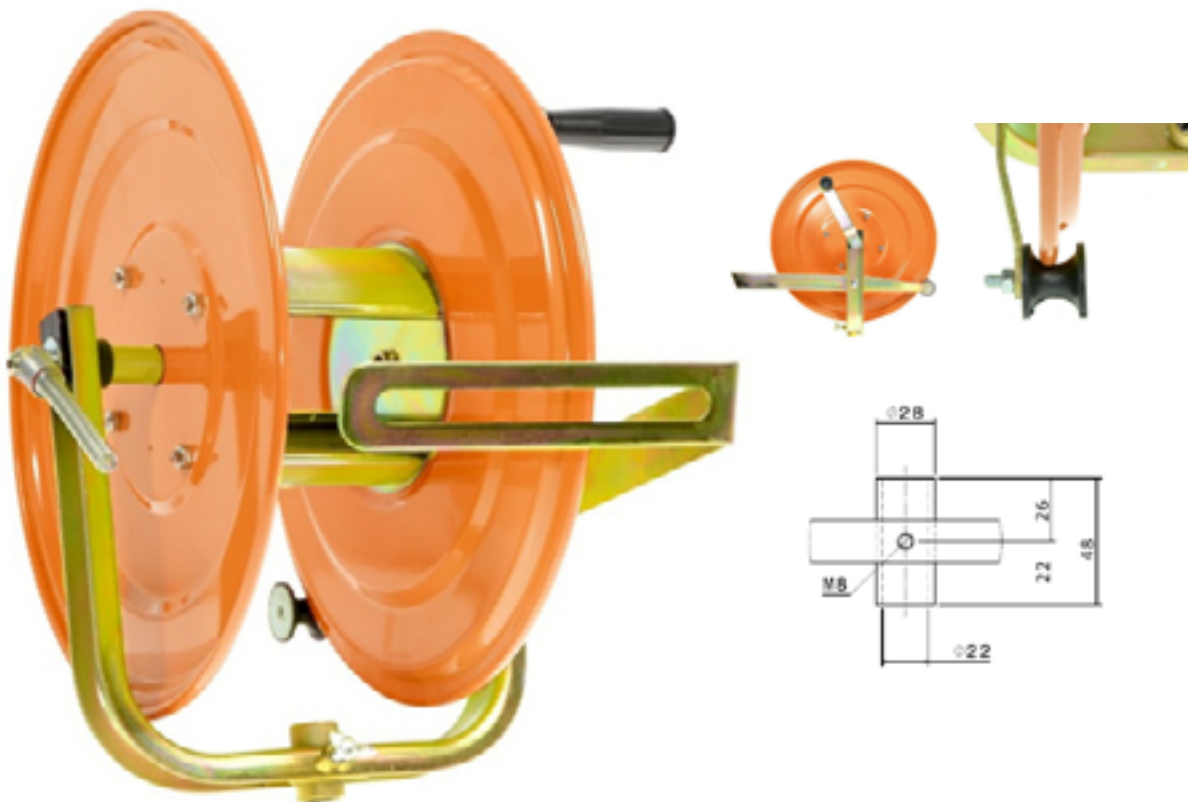

BREVETTATO PRO

Articolo	Lmt	€ Listino	
9710281	100	96,00	5
9710431	200	99,40	5

KIT SMONTATO AVVOLGITUBO ARIA COMPRESSA CON FRENO AUTOMATICO COMPLETO DI RACCORDO DA Ø10

CILLITEK III

Dotato di freno autobloccante a bilanciere brevettato.
Lo svolgimento della bobina avviene mediante una leggera trazione su tubo.
Al rilascio del tubo si aziona il freno, impedendo lo srotolamento involontario del tubo. Tamburo e struttura in metallo.

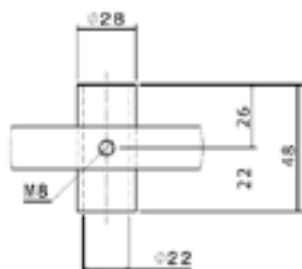

BREVETTATO PRO

Articolo	Lmt	€ Listino	CFM
9710280	100	90,00	4

PERNO PER AVVOLGITUBO



Articolo	€ Listino	
9700955	6,00	12

MANOPOLA RICAMBIO AVVOLGITUBO



Articolo	€ Listino	
0501850	4,00	12

Ricambio per: 0500350 - 0500400 - 0500460 - 9710281 - 9710431

**CILINDRO ANTERIORE SGOLATO
30 X 20 MF M8X18**



Articolo	€ Listino	
9722114	7,00	12

Ricambio per avvolgitubo

**ROTOLO TUBO ELASTOFLES PRO
IN POLIURETANO**



PRO

Articolo	Ø	Lmt	€ Listino	
9729430	8x10	100	124,00	1

**ROTOLO TUBO ELASTOFLES
IN POLIURETANO**



Articolo	Ø	Lmt	€ Listino	
9729431	7,5x10	25	30,00	2
9729434	7,5x10	50	50,00	2
9729438	7,5x10	100	110,00	1

BOBINA TUBO PRO 100 MT



PRO

Articolo	€ Listino		
9729427	6x8	102,00	1

**ROTOLO TUBO ELASTOFLES
IN POLIURETANO**



Articolo	Ø	Lmt	€ Listino	
9729425	5,5x8,0	100	82,00	1

MOTOCOMPRESSORI CILLITEK



Pedana
Antivibrante

INCLUSI:
Prese Multiple
Acceleratore
Automatico
Staffa
Avvolgitubo



Testata
Professionale
con collettore
raffreddamento
ABAC

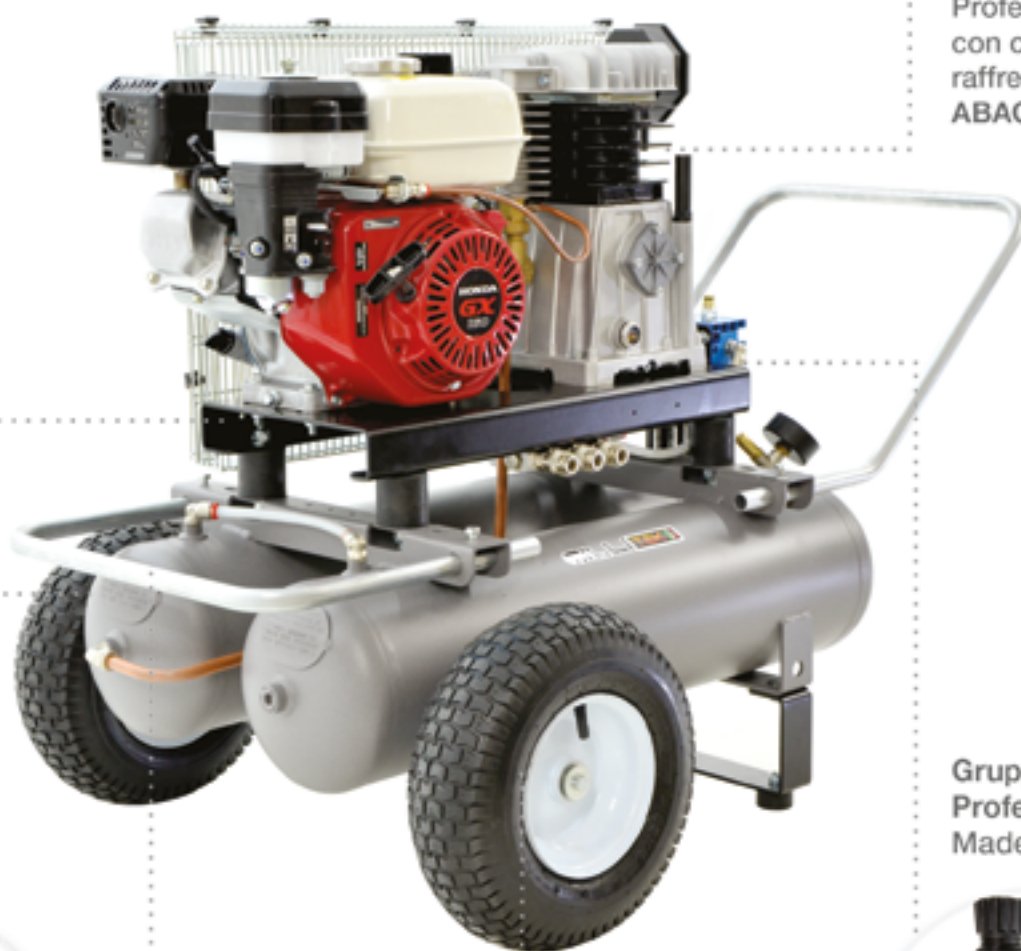

Bombole
Extra
22+22 Litri

Impugnatura
Protezione
anche posteriore

Ruote
Maggiorate
con cerchio
in metallo

Gruppo FRL
Professionale
Made in Italy



CILLITEK 

MOTOCOMPRESSORE PROFESSIONALE 22+22 lt

CILLI TEK III

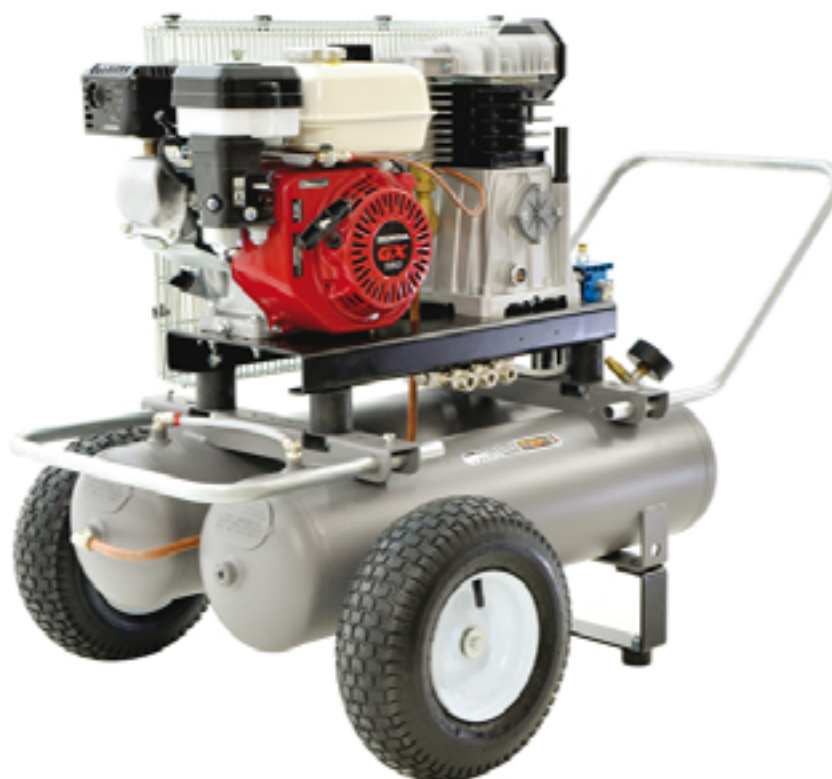

- MOTORE HONDA GX 160 
- TESTATA ABAC PROFESSIONALE 
- PEDANA ANTIVIBRANTE PER MOTORE E TESTATA
- ACCELERATORE AUTOMATICO
- STAFFA AVVOLGITUBO
- RUOTE MAGGIORATE CON CERCHIO METALLO
- BOMBOLE EXTRA 22+22 LITRI

BREVETTATO

PRO



Articolo	Motore	€ Listino	
9722029	DIESEL HP 4,7 AVV.A STRAPPO	2.080,00	1
9722027	DIESEL HP 6,7 AVV.ELETTRICO	2.600,00	1
9722023	HONDA GX160 BENZINA HP 5,5 AVV.A STRAPPO	1.720,00	1

	BENZINA HP5,5 AVV.A STRAPPO
Codice	9722023
Capacità serbatoio	22+22
Gruppo pompaggio	C470
Cilindri	2/1
Aria aspirata	476 l/min
Pressione max lavoro	10 bar
Giri al minuto	1400
Gruppo FRL italiano	3/8
Dimensioni	Lunghezza: 85cm-Altezza: 85 cm-Larghezza: 70cm
Forbici alimentate	6
Pettini alimentati	2
Seghetti alimentati	1



OPTIONAL 3 Punti trattore 9.722.028

MOTOCOMPRESSORE 10 lt.

CILLI TEK III



Carrello a sgancio rapido; base antivibrante per motore e testata.

Acceleratore automatico incluso

Staffa avvolgitubo

Testata Abac professionale

BREVETTATO PRO

Articolo	Motore	€ Listino	
9722006	HONDA Gx160 BENZINA HP 5,5	1.700,00	1
9722019	KAMA BENZINA HP 3,0	1.400,00	1

	BENZINA HP5,5 AVV.A STRAPPO
Capacità del serbatoio	10 litri
Pressione sonora	70
Potenza sonora	99 db
Gruppo di pompaggio	C470
Cilindri	2
Aria aspirata	476l/min
Pressione massima di lavoro	10 Bar
Giri al minuto	1250
Peso Lordo	67 Kg
Cubatura della macchina	0,130 senza ruote
Gruppo FRL italiano	1/4
Dimensioni	Larghezza 30+30cm Altezza 63/95cm(con carrello) Lunghezza 66cm
Forbici alimentate	5
Pettini alimentati	2

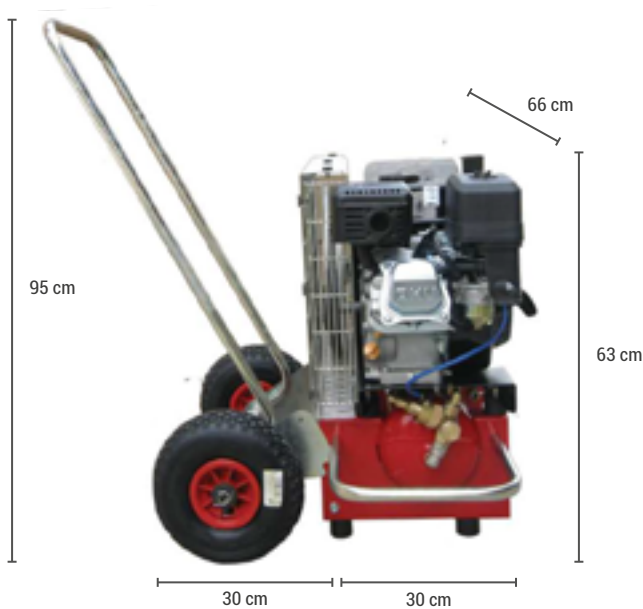



MOTORE HONDA GX 160 4 TEMPI 5,5 BENZINA



PRO

Articolo	Modello	€ Listino	
9722062	GX160	462,40	1
9700721	Interruttore di ricambio	10,869	1

KIT AVVIAMENTO PER GX160

Articolo	€ Listino	
9600952	56,00	1

CARATTERISTICHE

Motore monocilindrico	4 tempi a benzina.
Albero cilindrico diametro	19.05
Tipo di cilindro	in ghisa
Alesaggio x Corsa	68 x 45 mm
Cilindrata	163 cm ³
Rapporto di compressione	9.0 : 1
Potenza netta	3.6 kW (4.8 HP) / 3600 giri/min
Potenza nominale continua	2.5 kW (3.4 HP) / 3000 giri/min 2.9 kW (3.9 HP) / 3600 giri/min
Coppia massima	10.3 Nm/1.05 kgfm 2500 giri/min
Capacita' serbatoio	3.1 Litri
Consumo di combustibile alla potenza continuativa	1.4 L/O - 3600giri/min
Capacita' coppa olio	0.6 Litri
Dimensioni	312x362x346 mm
Peso a secco	15.1 kg



MOTORE BENZINA 6,5 HP



Articolo	€ Listino	
9722064	270,00	1

CARATTERISTICHE

Motore monocilindro	4 tempi raffreddamento forzato OHV
Cilindrata	196 cc
Alesaggio x Corsa	68 millimetri x 54mm (2.7 "x 2.1")
Potenza	4,1 Kw/3600 rpm
Coppia	12.4Nm (9.1 lbf.ft) / 2500rpm
Regime del minimo	1850 ± 150r/min
Rapporto di compressione	8.5:1
Rotazione della presa di forza	Antiorario (dal lato PTO)
Rumorosità' (7 m)	70 dB (A)
Sistema di accensione	Transistorizzato accensione a magnete
Sistema di avviamento	Avviamento autoavvolgente/elettrico-start
Carburatore	Farfalla
Sistema di lubrificazione	A caduta
Sistema	A massa centrifuga
Filtro aria	Semi-secco, a doppio elemento
Capacità olio	0.6L (0.16gal)
Capacità serbatoio carburante	3.6L (0.95gal)
Peso netto	16 kg
Dimensioni	312 x 376 x 335 mm

GRUPPO COMPRESSORE TRASMISSIONE A CINGHIA MONOSTADIO CON COLLETTORE PROFESSIONALE



- Teste in alluminio pressofuso con ampie alettature per un migliore raffreddamento.
- Carter dell'olio sovradimensionato per una migliore lubrificazione.
- Piastre-valvole speciali con elevatissima resistenza all'usura.



PRO

Articolo	€ Listino	
9721411	240,00	1

ARTICOLO	MOTORE	CILINDRI	STADI	ARIA ASPIRATA	N°GIRI	VOLANO	PRESSIONE MAX
9721411	3kW (4HP)	2	1	486 l/min	1300 RPM	390mm x 1A	10 Bar (145psi)

GRUPPO COMPRESSORE TRASMISSIONE A CINGHIA BISTADIO PROFESSIONALE



- Potenti, silenziosi e sicuri.
- Adatti ad impieghi gravosi.
- Progettati per durate molto elevate.
- Basso consumo di energia.
- Gruppi bistadio con raffreddamento intermedio fra le due fasi di compressione.



PRO

Articolo	Modello	€ Listino	
9722047	B6000	678,00	1

ARTICOLO	MOTORE	CILINDRI	STADI	ARIA ASPIRATA	N°GIRI	VOLANO	PRESSIONE MAX
9722047	5,5kW(7,5HP)	2	2	827 l/min (28,2 CFM)	1400 RPM	423mm x 2A	11 Bar

KIT GUARNIZIONI PER TESTATA 9721411



Kit guarnizioni per Gruppi Pompanti Abac PAT 38 B Adatto esclusivamente per gruppi pompanti PAT 38 B - Abac



Articolo	€ Listino	
9721433	53,00	4

OLIO PRO PER GRUPPI POMPANTI



Miscela di oli minerali altamente raffinati e additivi per testate. L'olio minerale altamente raffinato contiene <3% (p/p) di estratto inDMSO, secondo IP346.



Articolo	Tipo	€ Listino	
9799913	1000 ml	14,40	15

ATTACCO A "L" M-F GIREVOLE



PRO

Articolo	Ø X Ø	€ Listino	
9729289	1/4"x1/4"	4,92	20

RACCORDO A "L" MASCHIO AUTOMATICO



PRO

Articolo	Ø X Ø	€ Listino	
9729294	1/8 x 6	1,62	50
9729298	1/4 x 6	2,00	50
9729308	1/4 x 8	2,56	50
9729307	1/4 x 10	2,84	50
9729306	3/8 x 10	2,98	50

RACCORDO A "L" GIREVOLE MASCHIO AUTOMATICO



PRO

Articolo	Ø X Ø	€ Listino	
9729295	1/4" x 6	4,07	50
9729301	1/4" x 8	4,60	50
9729302	1/4" x 10	5,00	100

RACCORDO DRITTO MASCHIO AUTOMATICO



PRO

Articolo	Ø X Ø	€ Listino	
9729315	1/4 x 6	1,49	50
9729317	1/8 x 6	1,49	50
9729320	1/4 x 8	1,56	50
9729324	3/8 x 10	1,98	50
9729325	1/4 x10	2,34	50

ATTACCO A GIUNZIONE AUTOMATICO



PRO

Articolo	Ø X Ø	€ Listino	
9729285	6	2,42	50
9729290	8	2,60	50
9729291	10	3,10	50

ATTACCO MASCHIO GIREVOLE CON MOLLA



PRO

Articolo	Ø X Ø	€ Listino	
9729200	4x6	2,68	25
9729205	6x8	2,68	25
9729210	8x10	2,88	100

Raccordo maschio per tubo aria, tipo girevole. Filetto 1/4"

ATTACCO MASCHIO FISSO CON MOLLA



PRO

Articolo	Ø X Ø	€ Listino	
9729220	4x6	1,83	25
9729225	6x8	1,83	25
9729230	8x10	2,88	100

Raccordo maschio per tubo aria, tipo fisso. Filetto 1/4"

ATTACCO A BAIONETTA CON MOLLA GIREVOLE



PRO

Articolo	Ø X Ø	€ Listino	
9729165	6x8	1,91	100
9729170	8x10	2,18	50

Attacco rapido con molla a spirale

INNESTO PER RUBINETTO RAPIDO CON MOLLA



PRO

Articolo	Ø X Ø	€ Listino	
9729240	4x6	1,60	25
9729245	6x8	2,00	50
9729250	8x10	2,60	50

Attacco per rubinetto rapido con molla a spirale

RUBINETTO RAPIDO CON MOLLA



PRO

Articolo	Ø X Ø	€ Listino	
9729265	6x8	4,90	50
9729270	8x10 UNI	5,10	50
9729271	8x10 ITA	4,90	50

Rubinetto rapido per tubo aria, con molla

RUBINETTO RAPIDO PER ARIA MASCHIO



PRO

Articolo	Filetto	€ Listino	
9729355	1/4"	4,70	50
9729360	3/8"	4,90	50
9729365	1/2"	5,00	50

INNESTO PER RUBINETTO MASCHIO

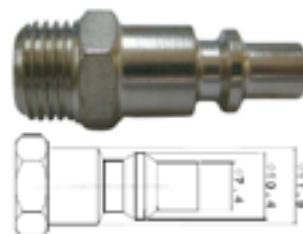

PRO

Articolo	Filetto	€ Listino	
9729310	1/4"	1,12	100
9729312	3/8"	1,26	100

NIPPLO FILETTATO M-M



PRO

Articolo	Filetto	€ Listino	
9729382	1/8"	0,65	100
9729383	1/4"	0,73	100
9729384	3/8"	1,20	100
9729386	1/2"	1,74	50

MANICOTTO FILETTATO F-F



PRO

Articolo	Filetto	€ Listino	
9729390	1/4"	1,00	100
9729388	1/2"	2,00	50
9729389	3/8"	1,20	50

RACCORDO A "Y" F-F-F



PRO

Articolo	Tipo	€ Listino	
9729385	1/4"	2,18	25

RACCORDO A "Y" M-F-F



PRO

Articolo	Tipo	€ Listino	
9729380	1/4"	2,20	50
9729381	3/8"	3,38	50



Per informazioni tecniche, foto e prezzi aggiornati visita il nostro sito www.cillisrl.com

RACCORDO A "L" M-F



PRO

Articolo	Tipo	€ Listino	
9729392	3/8	1,87	50
9729394	1/8	1,06	25
9729395	1/4	2,16	25

RUBINETTO A SFERA M-F



PRO

Articolo	Tipo	€ Listino	
9729366	1/4	4,89	20
9729367	3/8	4,96	20

RUBINETTO A SFERA F-F 3/8



PRO

Articolo	Tipo	€ Listino	
9729368	3/8	5,81	20

RUBINETTO A SFERA M-F 1/4 MIGNON



PRO

Articolo	Tipo	€ Listino	
0114820	1/4	6,00	20

TEE FEMMINA 1/4



PRO

Articolo	Tipo	€ Listino	
9729364	1/4	2,16	100

TEE F-F-M



PRO

Articolo	Tipo	€ Listino	
9729362	1/2	4,51	100
9729369	3/8	2,63	100

RIDUZIONE CILINDRICA



PRO

Articolo	Tipo	€ Listino	
9729407	3/8x1/4	1,00	100
9729408	3/8x1/2	1,20	100
9729411	1/2x1/4	1,36	100

PROLUNGA CILINDRICA



PRO

Articolo	Tipo	€ Listino	
9729404	1/4x1/4x51	1,74	100

TAPPO CILINDRICO MASCHIO

CILLI|TEK



PRO

Articolo	Tipo	€ Listino	
9729153	3/8	0,96	100
9729155	1/2	1,46	100

RIPARTITORE ALLUMINIO

CILLI|TEK



PRO

Articolo	Tipo	€ Listino	
9729375	3/8x1/4-4vie	12,80	50
9729376	3/8x1/4-3vie	11,04	50

VALVOLA SICUREZZA 1/4



PRO

Articolo	Tipo	€ Listino	
9729397	8 ATM	10,88	100
9729313	12 ATM	12,60	100

VALVOLA SICUREZZA 1/4 - TARATA 12 BAR



PRO

Articolo	Tipo	€ Listino	
9729398	12 ATM	4,00	50

RIDUTTORE DI PRESSIONE CON MANOMETRO



Articolo	€ Listino	
9740048	31,28	2

MANOMETRO A SECCO 0-12 BAR



Articolo	Ø	Filetto	€ Listino	
9729399	50	1/8	5,40	20
9729405	63	1/4	5,50	20
9729415	40	1/8	5,00	20

MANOMETRO A SECCO 0-120 BAR



Articolo	Ø	Filetto	€ Listino	
1500005	50	1/4	5,00	20

VALVOLA PILOTA AUTOMATICO CON PREDISPOSIZIONE ACCELERATORE



PRO

Articolo	Filetto	€ Listino	
9721439	3/8	74,00	3
9721440	1/2	85,00	3
9721443	3/4	108,00	3

VALVOLA PILOTA AUTOMATICO CON PREDISPOSIZIONE ACCELERATORE



a

c

PRO

Articolo	€ Listino	
9721441 a) mod. H	29,50	3
9721447 b) A20 C20	13,10	3

OLIO LUBRIFICANTE PER ATTREZZI PNEUMATICI

CILLI TEK III



Articolo	Tipo	€ Listino	
9700930	1000 ml	8,30	20
9700935	125 ml	2,40	40

Biodegradabile, altamente raffinato, atossico, idoneo per la lubrificazione di abbacchiatori, scuotitori, gevolatori, nastri trasportatori per alimenti, ove accidentalmente dovesse avvenire contatto con alimenti

FILTRO RIDUTTORE LUBRIFICATORE

CILLI TEK III

Articolo	Filetto	€ Listino	
9729400	1/4"	64,00	3

Portata: 1800N/L min 6 Bar

Articolo	Filetto	€ Listino	
9729401	3/8"	85,70	3

Portata: 5000N/L min 6 Bar



N°	Codice	FILTRO REGOLATORE MOD.AT-FRM 1/4"	LISTINO
1-8	9728071	CAMPANA COMPLETA X FR/FRM 1/4	15,40
9		TAPPO VALVOLA	
11		VALVOLA	
12		MOLLA	
13		OR	
15		GRANO	
16		CORPO	
17	9729415	MANOMETRO 1/8 D40 X FR 1/4	5,00
19-23		CONVOGLIATORE	
24	9728070	TAZZA METALLICA X FRM 1/4	15,04

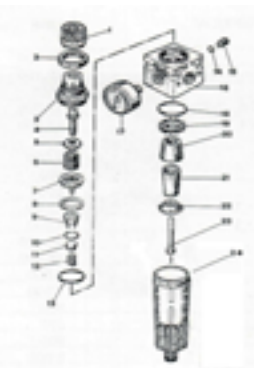

N°	Codice	FILTRO REGOLATORE MOD.AT-FRM 3/8"	LISTINO
1-8	9728075	CAMPANA COMPLETA X FR/FRM 3/8	26,00
9		OR	
10	9729399	MANOMETRO D50 1/8 X FR 3/8	5,40
11		GRANO 3/8	
12		OR	
13		PERNO VALVOLA 3/8	
14		CORPO 3/8	
15		VALVOLA 3/8	
16		OR	
17		MOLLA	
18		PORTA VALVOLA 3/8	
19-23		CONVOGLIATORE 3/8	
24	9728081	OR X 3/8	0,45
25	9728074	TAZZA METALLICA X FRM 3/8	21,80

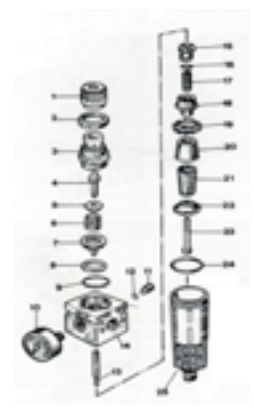

N°	Codice	FILTRO REGOLATORE MOD.AT-FRM 1/4	LISTINO
1-3	9728078	CUPOLINA COMPLETA+OR 1/4-3/8	6,00
4		OR	
5		CORPO 1/4	
5 A		CORPO 3/8	
6		MEMBRANA	
7		UGELLO	
8	9728077	OR X 1/4	0,45
8 A	9728081	OR X 3/8	0,45
9		TAPPO	
10	9728079	OR X 1/4-3/8	0,33
11	9728086	ATTACCO TUBO X 1/4-3/8	1,62
12	9728087	TUBO X 1/4	0,76
12 A	9728084	TUBO X 3/8	0,76
13	9728088	FILTRO BRONZO X 1/4-3/8	0,70
14	9728072	TAZZA METALLICA 1/4	14,83
14 A	9728076	TAZZA METALLICA 3/8	19,20

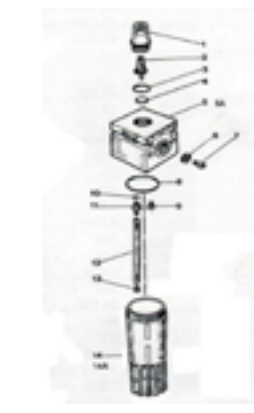

DEFOGLIATORE PNEUMATICO

Si tratta di un attrezzo utile per rimuovere foglie e piccole particelle anche da piccoli frutti e granaglie quali: nocchie, mandorle, mais e legumi quali fagioli, ceci, fave, ecc.

Il defogliatore è alimentato ad aria compressa, avendo incorporato il gruppo lubrificatore, può essere collegato ad un qualsiasi compressore. Costruito in metallo molto robusto, rifinito artigianalmente motivo per il quale vi si possono trovare delle imperfezioni estetiche che non ne precludono il corretto funzionamento. Compatto e facilmente spostabile grazie alle ruote anteriori.

PRO 

Articolo	€ Listino	
9701323	518,00	1



CARATTERISTICHE TECNICHE

Modello	Pneumatico	Pressione sonora	91,5 db
Alimentazione	Aria compressa	Produzione oraria	25 quintali
Pressione d'esercizio	6,2 bar	Dimensioni totali	60x96x102h
Giri min.	2700	Ventola	19 cm
Consumo d'aria	180 lt/min		

DEFOGLIATORE ELETTRICO CON REGOLATORE DI POTENZA

Defogliatore elettrico zincato a ventilazione forzata. Elimina perfettamente foglie, rametti e le varie impurità che si depositano sulle olive assicurando così un ottimo olio extravergine di qualità. La macchina è fornita con cavo di alimentazione da mt. 1, scatola in materiale isolante con interruttore elettrico con regolatore di velocità, motore elettrico, ventola con griglia di protezione. Si tratta di un attrezzo utile per rimuovere foglie e piccole particelle anche da piccoli frutti e granaglie quali: nocchie, mandorle, mais e legumi quali fagioli, ceci, fave, ecc.

PRO 

Articolo	€ Listino	
9701328	544,00	1



CARATTERISTICHE TECNICHE

Modello	Elettrico	Produzione media Kg/ora	3000
Potenza motore	350 W	Lunghezza cm	90
Tensione alimentazione	220-50/60 Hz	Altezza	105
Giri min.	2900	Larghezza cm	61
Peso in scatola	31 kg		

DEFOGLIATORE ELETTRICO SENZA GRIGLIA

Defogliatore elettrico zincato a ventilazione forzata. Elimina perfettamente foglie, rametti e le varie impurità che si depositano sulle olive grazie ad una griglia di primo passaggio assicurando così un ottimo olio extravergine di qualità. E' dotato di griglia di protezione per la ventola e convogliatore aria. Motore elettrico dotato di regolatore di velocità della ventola. N. 2 maniglie per una presa comoda e sicura ed è facilmente trasportabile grazie alle 2 ruote posizionate sul davanti. Si tratta di un attrezzo utile per rimuovere foglie e piccole particelle anche da piccoli frutti e granaglie quali: nocciole, mandorle, mais e legumi quali fagioli, ceci, fave, ecc.



PRO  

Articolo	€ Listino	
9701325	503,20	1

CARATTERISTICHE TECNICHE

Modello	Elettrico		
Dimensioni	60x115x106h		
Dimensioni interne vasca	64x59x34h		
Dimensione rampa regolabile	37x41 cm		

DEFOGLIATORE ELETTRICO CON GRIGLIA

Defogliatore elettrico zincato a ventilazione forzata. Elimina perfettamente foglie, rametti e le varie impurità che si depositano sulle olive grazie ad una griglia di primo passaggio assicurando così un ottimo olio extravergine di qualità. E' dotato di griglia di protezione per la ventola e convogliatore aria. Motore elettrico dotato di regolatore di velocità della ventola. N. 2 maniglie per una presa comoda e sicura ed è facilmente trasportabile grazie alle 2 ruote posizionate sul davanti. Si tratta di un attrezzo utile per rimuovere foglie e piccole particelle anche da piccoli frutti e granaglie quali: nocciole, mandorle, mais e legumi quali fagioli, ceci, fave, ecc.



PRO  

Articolo	€ Listino	
9701322	598,40	1

CARATTERISTICHE TECNICHE

Modello	Elettrico		
Dimensioni	60x115x106h		
Dimensioni interne vasca	64x59x34h		
Dimensione rampa regolabile	37x41 cm		

DEFOGLIATORE A SCOPPIO CON GRIGLIA

Defogliatore a scoppio zincato a ventilazione forzata. Elimina perfettamente foglie, rametti e le varie impurità che si depositano sulle olive grazie ad una griglia di primo passaggio assicurando così un ottimo olio extravergine di qualità. E' dotato di griglia di protezione per la ventola e convogliatore aria. N. 2 maniglie per una presa comoda e sicura ed è facilmente trasportabile grazie alle 2 ruote posizionate sul davanti. Si tratta di un attrezzo utile per rimuovere foglie e piccole particelle anche da piccoli frutti e granaglie quali: nocchie, mandorle, mais e legumi quali fagioli, ceci, fave, ecc..



PRO ■ ■

Articolo	€ Listino	
9701330	723,52	1

CARATTERISTICHE TECNICHE

Modello	A scoppio	Profondità vasca dalla griglia al bordo	10 cm
Potenza	2,5 Hp	Tipo motore	4 tempi
Cilindrata	97 cc	Alimentazione	Benzina
Giri min.	3600	Capacità serbatoio	1,6 lt
Dimensioni	60x115x106h		

DEFOGLIATORE A SCOPPIO SENZA GRIGLIA

Defogliatore a scoppio zincato a ventilazione forzata. Elimina perfettamente foglie, rametti e le varie impurità che si depositano sulle olive assicurando così un ottimo olio extravergine di qualità. E' dotato di griglia di protezione per la ventola e convogliatore aria. N. 2 maniglie per una presa comoda e sicura ed è facilmente trasportabile grazie alle 2 ruote posizionate sul davanti. Si tratta di un attrezzo utile per rimuovere foglie e piccole particelle anche da piccoli frutti e granaglie quali: nocchie, mandorle, mais e legumi quali fagioli, ceci, fave, ecc.



PRO ■ ■

Articolo	€ Listino	
9701333	625,60	1

CARATTERISTICHE TECNICHE

Modello	A scoppio	Tipo motore	4 tempi
Potenza	2,5 Hp	Alimentazione	Benzina
Cilindrata	97 cc	Capacità serbatoio	1,6 lt
Giri min.	3600		
Dimensioni	60x115x95h		

DEFOGLIATORE MANUALE PIEGHEVOLE 190 X 80CM

CILLI TEK III

Si tratta di un attrezzo utile per rimuovere foglie e piccole particelle anche da piccoli frutti e granaglie quali: nocchie, mandorle, mais e legumi quali fagioli, ceci, fave, ecc. Il defogliatore è richiudibile a portafogli in modo da essere poco ingombrante e facilmente trasportabile. Costruito in acciaio zincato molto robusto, rifinito artigianalmente motivo per il quale vi si possono trovare delle imperfezioni estetiche che non ne precludono il corretto funzionamento.

PRO  



Articolo	€ Listino	
9701321	228,00	1

CARATTERISTICHE TECNICHE

Lunghezza totale aperto	190 cm	Larghezza interna	56 cm
Altezza posteriore	90 cm	Altezza interna	8,5 cm
Altezza anteriore	60 cm	Dimensioni bocca anteriore	25 x 8,5 cm
Larghezza	60 cm	Distanza tra le barre	Variabile da 0,7 a 1 cm
Ingombro totale con piedi a terra	223 x 60 cm	Dimensioni chiuso	98 x 60 x 27 cm

SET 100 SACCHI RACCOLTA AGRICOLI



Articolo	Misura	Capienza Kg	€ Listino	
5506300	45X85	25 Bianco	39,20	5
5506304	60X100	50 Bianco	50,40	5
5506308	70X120	100 Blu	70,00	3

SACCO DI JUTA USATO E RICONDIZIONATO



Articolo	Capienza Kg	€ Listino	
5506310	50	1,54	40
5506312	100	1,82	40

Attenzione, i seguenti sacchi sono usati, ma sono stati ricondizionati e sterilizzati.

PINZA RACCOLTA ULIVO BREVETTATA



Articolo	€ Listino	
5505500	14,00	12

CILLI TEK III

RASTRELO PER OLIVE



Articolo	Denti	€ Listino	
5505007	7 ARANCIO	0,50	500
5505010	9 GIALLO	0,60	500

Manico bucato con possibilità di applicarci manico rastrello o scopa.
Codice manico compatibile: 9686158.

CILLI TEK III

SCOPA PER FOGLIE E OLIVE



Rossa con rinforzo

Gialla senza rinforzo

Articolo	Colore	€ Listino	
9140130	ROSSO	2,33	100
9140140	GIALLO	2,33	100

CILLI TEK III

SCOPA PRO PER FOGLIE E OLIVE NYLON



Articolo	Denti	€ Listino	
9140170	21	6,16	100

CILLI TEK III

LATTINA OLIO CON TAPPO



Articolo	Lt	€ Listino	1 box	3 box	5 box	
5240002	2	2,27				60
5240005	5	2,88				60
5240010	10	5,50				30



Per informazioni tecniche, foto e prezzi aggiornati visita www.minox.it

MINOX

CONTENITORE INOX

Il contenitore fondo piano saldato fa parte di contenitori e recipienti per olio e altri liquidi alimentari, realizzati in acciaio inox e saldati. Questo contenitore è ideale per il trasporto e il trattamento di qualunque liquido alimentare, in grandi quantità. Il prezzo include il coperchio e pomello.

INOX

Articolo	Lt	€ Listino	
5250100	100	124,00	1
5250200	200	191,49	1
5250300	300	228,00	1
5250500	500	314,00	1



MINOX

DAMIGIANA INOX EXTRA

Il fusto graffiato per olio fa parte dei contenitori e recipienti per olio e altri liquidi, in acciaio inox e con chiusura ermetica. Questo recipiente ripropone il design dei tradizionali contenitori italiani e garantisce una perfetta conservazione del liquido contenuto. È ideale anche per lo stoccaggio di succhi di frutta, tè, acqua, aceto etc.

INOX

Articolo	Lt	€ Listino	
5240030	30	61,20	3
5240050	50	74,80	3
5240100	100	125,12	1



MINOX

GELLEGGIANTE INOX OLIO



INOX

Articolo	Lt	€ Listino	
5263390	100	39,30	1
5263490	200	51,34	1
5263700	500	73,50	1
5263720	1000	135,14	1

CLLITEK III

KIT SOSTEGNO UNISUPER REGOLABILE



BREVETTATO

Articolo	kg	∅	€ Listino	
5060510	200 max	380-500 mm	34,00	6
5060515	500 max	500-700 mm	47,00	6
5060520	800 max	700-980 mm	73,00	6

Un unico sostegno adattabile a più misure di fusti. Completo di dadi e bulloni per il montaggio. Altezza 350 mm

RETI PER OLIVE ANTISPINA

CILLI TEK III

- Tipo pesante
- Maglia antispina
- Occhiellato
- Bordatura perimetrale di rinforzo
- Stabilizzato contro i raggi UV
- In polietilene alta densità

Bordatura perimetrale di rinforzo



Maglia antispina



Occhielli agli angoli

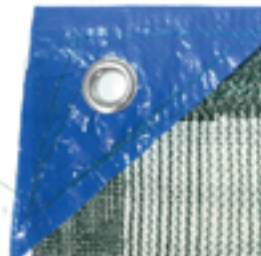

Tagliando di garanzia



ROTOLO RETE OLIVE ANTISPINA

CILLI TEK III

Articolo	Lmt	€ Listino	
5506106	6x50	215,56	1
5506270	7x50	251,22	1
5506104	8x50	287,26	1



RETE OLIVE ANTISPINA

CILLI TEK III

Articolo	Lmt	€ Listino	
5506140	4X6	18,72	15
5506150	4X8	24,96	10
5506160	5X10	39,00	8
5506170	6X10	46,80	6
5506180	6X12	56,16	5
5506210	6X8	37,44	8
5506225	8X10	62,40	5
5506230	8X12	74,88	4
5506260	10X12	93,60	3



RETE OLIVE ANTISPINA CON SPACCO CENTRALE

CILLI TEK III

Articolo	Lmt	€ Listino	
5506200	6X6	28,08	10
5506220	8X8	49,92	6
5506240	10X10	78,00	4
5506250	12X12	112,32	3





ENOLOGIA



FILTRO INOX 20 CON POMPA OTTONE PROFESSIONALE GIRANTE IN OTTONE

CILLI TEK III

• La pompa filtro INOX, ha un sistema filtrante liquido a strati pressati. Questo particolare tipo di filtraggio permette di ottenere ottimi livelli di purificazione dei liquidi. E' particolarmente apprezzato per filtraggi domestici, ma anche nel settore professionale e nel giardinaggio.



Articolo	Filtri	€ Listino	
6040020	20	412,00	1

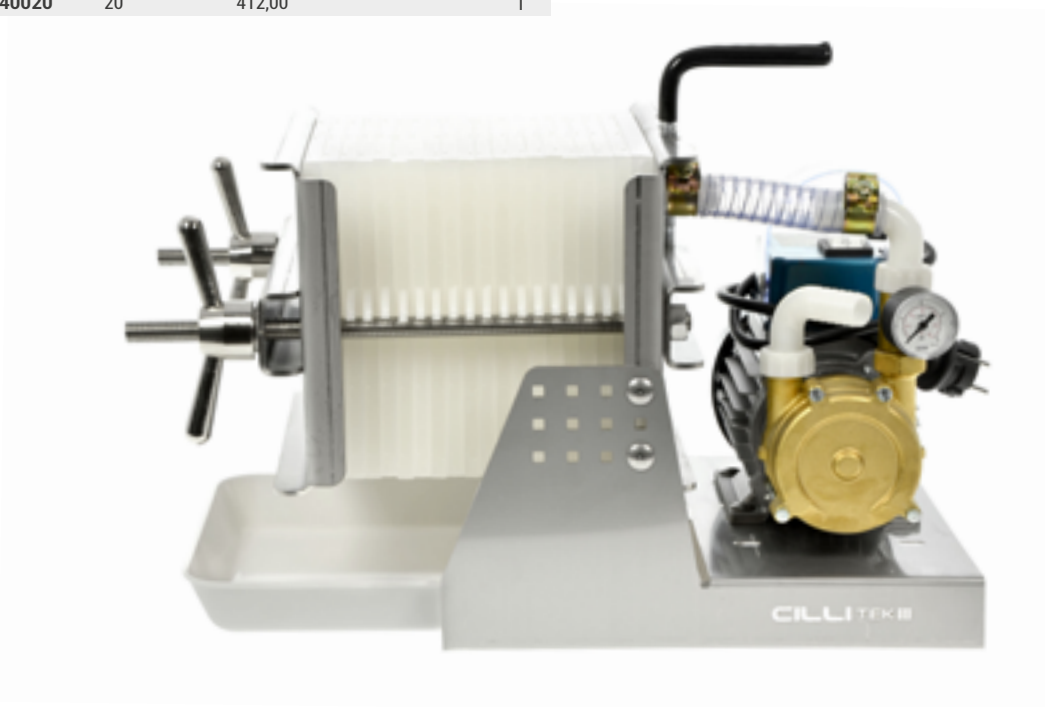

IL FILTRO MONTA L'ELETTROPOMPA 6000520

Utilizza cartoni filtranti 20x20 con 2 fori (6030000 - 6030030 - 6030002 - 6030004 - 6030008 - 6030016 - 6030020 - 6030024)

Non richiede particolare manutenzione, ma solo un'accurata pulizia dopo l'utilizzo.

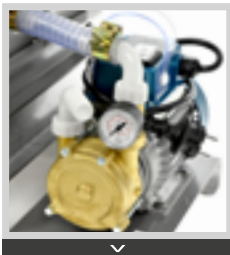

Elettropompa professionale



Pompa bisenso



Solida struttura



Girante in ottone



20 Filtri in omaggio cod. 6030004

Per informazioni tecniche, foto e prezzi aggiornati visita il nostro sito www.cillisrl.com

CILLI TEK III

FILTRO INOX 20 CON POMPA INOX PROFESSIONALE GIRANTE IN ACCIAIO

• La pompa filtro INOX, ha un sistema filtrante liquido a strati pressati.

Questo particolare tipo di filtraggio permette di ottenere ottimi livelli di purificazione delle

bevande senza alterare le caratteristiche fondamentali del liquido travasato; per questo è particolarmente apprezzato per filtri domestici, ma anche nel settore professionale, come per esempio cantine enologiche, fabbriche farmaceutiche, laboratori, fabbriche di birra.

Perfetto per la purificazione dei liquidi:

succhi di frutta, mosti d'uva, vino, olio, liquori, acqua, aceto, spumanti, profumi, cosmetici, ecc..



Articolo	Filtri	€ Listino	
6040030	20	614,00	1

IL FILTRO MONTA L'ELETTROPOMPA 6000425

Utilizza cartoni filtranti 20x20 con 2 fori (6030000 - 6030030 - 6030002 - 6030004 - 6030008 - 6030016 - 6030020 - 6030024) Non richiede particolare manutenzione, ma solo un'accurata pulizia dopo l'utilizzo.



Girante in acciaio
Inox AISI

20 Filtri in omaggio
cod. 6030004

CILLI TEK III

FILTRO INOX CARRELLATO GRANDE ALE 25

• La pompa filtro INOX, ha un sistema filtrante liquido a strati pressati.

Questo particolare tipo di filtraggio permette di ottenere ottimi livelli di purificazione delle

bevande senza alterare le caratteristiche fondamentali del liquido travasato; per questo è particolarmente apprezzato per filtri domestici, ma anche nel settore professionale, come per esempio cantine enologiche, fabbriche farmaceutiche, laboratori, fabbriche di birra;

Perfetto per la purificazione dei liquidi:

succhi di frutta, mosti d'uva, vino, olio, liquori, acqua, aceto, spumanti, profumi, cosmetici, ecc..



Articolo	Filtri	€ Listino	
6040010	20	880,00	1

IL FILTRO MONTA L'ELETTROPOMPA 6000425

Utilizza cartoni filtranti 20x20 con 2 fori (6030000 - 6030030 - 6030002 - 6030004 - 6030008 - 6030016 - 6030020 - 6030024) Non richiede particolare manutenzione, ma solo un'accurata pulizia dopo l'utilizzo.



Struttura pesante in
acciaio inox



Girante in acciaio
Inox AISI



20 Filtri in omaggio
cod. 6030004

FILTRO 20 INOX SENZA POMPA

CILLITEK III



Articolo	€ Listino	
6040050	360,00	1

• Utilizza cartoni filtranti 20x20 2 fori (art. 6.030..)
STRUTTURA IN ACCIAIO INOX

PIASTRA INTERMEDIA PER DEPURA S

CILLITEK III

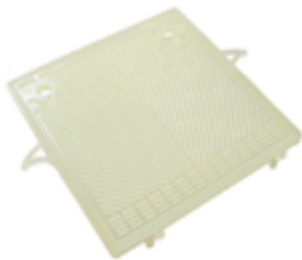

Articolo	Lcm	€ Listino	
6030225	20x20	6,00	10

PIASTRA FINALE PER DEPURA S

CILLITEK III

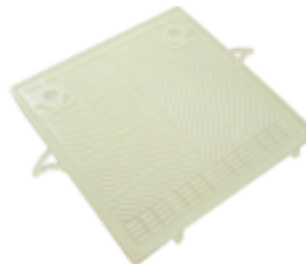

Articolo	Lcm	€ Listino	
6030226	20x20	6,00	10

PIASTRA CON PORTAGOMMA PER DEPURA S

CILLITEK III



Articolo	Lcm	€ Listino	
6030228	20x20	10,00	10



C00 codici 6030000 / 6010052

Grammatura 680-900gr/mq Spessore 3.60 mm
Esempi di applicazione: filtrazione dell'olio.
Ritenzione nominale - 45 micron.

C0 codici 6030030 / 6010090

Grammatura 680-900gr/mq Spessore 3.60 mm
Esempi di applicazione: filtrazione di succhi di frutta, mosti di uva, sgrassanti, eliminazione di grosse particelle, soluzione di sali metallici, industrie chimiche ecc.
Ritenzione nominale - 25 micron.

C4 codici 6030002 / 6010062

Grammatura 930-1150gr/mq Spessore 3.75 mm
Esempi di applicazione: filtrazione di succhi di frutta, mosti di uva, sgrassanti, eliminazione di grosse particelle, soluzione di sali metallici, industrie chimiche ecc.
Ritenzione nominale - 10 micron.



C8 codici 6030004 / 6010060

Grammatura 940-1060gr/mq Spessore 3.75 mm
Esempi di applicazione: filtrazione di succhi di frutta, mosti di uva, sgrassanti, eliminazione di grosse particelle, soluzione di sali metallici, industrie chimiche ecc.
Ritenzione nominale - 3 micron.

C12 codici 6030008 / 6010068

Grammatura 1020-1260 gr/mq Spessore 3.75 mm
Esempi di applicazione: filtrazione di vini giovani, primi vini, mosti di uva, vini mucosi, estratti viscosi e concentrati a base di vino, liquori, spirito oli vegetali, sidro, prefiltrazione dell'aceto, oli minerali industriali, solventi caricati, cere, lacche.
Ritenzione nominale - 1,5 micron.



C16 codici 6030016 / 6010076

Grammatura 1135-1395 gr/mq Spessore 3.75 mm
Esempi di applicazione: vini rossi da imbottigliare, vini vecchi depositati, vini dolci, chiarificazione di vini rosè e bianchi prima della filtrazione sterilizzante, spumante, filtrazione finale di sidro e aceto, imbottigliamento a caldo, estratti alcolici, cognac, whisky, acqua carica di ossido metallico, chiarificazione di estratti, eliminazione di tracce metallico ed elementi di carbone attivo, acqua di condensa.
Ritenzione nominale - 0,9 micron.

C20 codici 6030020 / 6010080

Grammatura 1190-1460 gr/mq Spessore 3.75 mm
Esempi di applicazione: imbottigliamento di vini rossi, vini rosè prefiltrati, vini di qualità che richiedono brillantante, aperitivi, spumanti, champagne, sidro, alcool bianco e colorato, cognac rhum, grappa, liquidi medicali prima della sterilizzazione, tutte le prefiltrazioni precedenti la sterilizzazione, eaux de toilette, profumi, cosmetici, estratti vegetali, alcolici ed acquosi molto fluidi, acque di condensa, carboni attivi, fitofarmaci, prefiltrazione di vaccini, prefiltrazione di plasma.
Ritenzione nominale - 0.7 micron.

C28 codici 6030024 / 6010084

Grammatura 1300-1500 gr/mq Spessore 3.80 mm
Esempi di applicazione: filtrazione sterilizzante a freddo, consente una presterilizzazione prima del passaggio sulla membrana da 0.22 micron, filtrazione finale di vino bianco ricco di zucchero residuo, spumanti, antibiotici, battericidi, antisettici, cicatrizzanti, prodotti di sintesi.
Ritenzione nominale - 0,3 micron.

**CARTONE FILTRANTE PURATECH
20X20 2 FORI**



PREZZO RIFERITO AL SINGOLO CARTONE
Cartoni filtranti adatti alle pompe filtro CilliTek

- 6010020
- 6010050
- 6010018
- 6040000
- 6040020
- 6040010
- 6040030
- 6040050

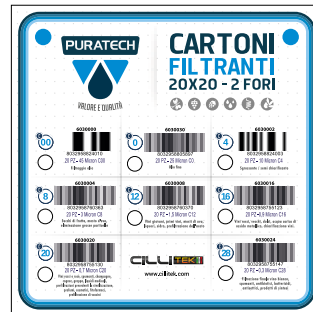

Articolo	Tipo	€ Listino	CFM
6030000	C00	0,79	20
6030030	C0	0,78	20
6030002	C4	0,78	20
6030004	C8	0,70	20
6030008	C12	0,70	20
6030016	C16	0,70	20
6030020	C20	0,72	20
6030024	C28	0,82	25

**CARTONE FILTRANTE PURATECH
20X20 UNIVERSALE**



PREZZO RIFERITO AL SINGOLO CARTONE



Articolo	Tipo	€ Listino	CFM
6010052	CU00	0,82	20
6010090	CU0	0,80	20
6010062	CU4	0,80	20
6010060	CU8	0,72	25
6010068	CU12	0,72	25
6010076	CU16	0,72	20
6010080	CU20	0,74	20
6010084	CU28	0,80	25

CARATTERISTICHE

C/CU00	45 Micron	Olio
C/CU0	25 Micron	Olio fine
C/CU4	10 Micron	Sgrossante
C/CU8	3 Micron	Sgrossante fine
C/CU12	1,5 Micron	Medio brillantante
C/CU16	0,9 Micron	Brillantante
C/CU20	0,7 Micron	Super sterilizzante
C/CU28	0,3 Micron	Super brillantante

Per informazioni tecniche, foto e prezzi aggiornati visita il nostro sito www.cillisrl.com

FILTRI CARTA PIEGATI 100 PEZZI



Articolo	Ø	€ Listino	
0033000	40 cm	49,80	3
0033002	50 cm	75,00	3

**FILTRO CONICO IN TELA
DI COTONE LAVABILE E RIUTILIZZABILE**



Articolo	Lt	Lcm	€ Listino	
0034010	10	22x46	7,00	10
0034020	20	26x56	8,00	10
0034030	30	34x68	9,70	10
0034040	40	40x78	12,00	10

FILTRO ENOLOGICO A SACCO IN TELA



Articolo	Lcm	€ Listino	
0036150	8x104	11,70	5
0036200	10x108	13,88	5
0036250	14x106	17,01	5
0036300	80x300	22,86	5

**RETE PER FILTRO ENOLOGICO
A SACCO IN TELA**



Articolo	Lcm	€ Listino	
0036100	14x83	6,93	10

**CAMPANA OTTONE
PER FILTRO A SACCO 13CM**

Articolo	Ø	€ Listino	
1924060	5x6,4 cm	22,60	12



ELETTROPOMPA TRAVASO ACCIAIO ALE



Girante in acciaio



Articolo	Ø	Hp	€ Listino	
6000425	25	0,5	258,40	1
6000430	30	1,0	299,20	1
6000440	40	1,2	340,00	1

• Elettropompa a bassi giri, ideale per il travaso dell'olio.

CARATTERISTICHE 6000425

Volt	220
Altezza max	5 m
Prevalenza max	23 l/min
r.p.m.	1400

CARATTERISTICHE 6000430

Volt	220
Altezza max	10 m
Prevalenza max	31 l/min
r.p.m.	1400

CARATTERISTICHE 6000440

Volt	220
Altezza max	10 m
Prevalenza max	53 l/min
r.p.m.	1400

ELETTROPOMPA BISENSO OTTONE



Girante in ottone



Articolo	Ø	Hp	€ Listino	
6000520	20	0,5	78,80	3

CARATTERISTICHE

Volt	220
Altezza max	27 m
Prevalenza max	1700 l/ora
r.p.m.	2800

- Elettropompa travaso liquidi bisenso
- Girante in ottone
- Albero in acciaio INOX AISI 304

ELETTROPOMPA BISENSO OTTONE



Girante in ottone



Articolo	Ø	Hp	€ Listino	
6000527	25	0,6	104,20	2

CARATTERISTICHE

Volt	220
Altezza max	27 m
Prevalenza max	2600 l/ora
r.p.m.	2800

- Elettropompa travaso liquidi bisenso
- Girante in ottone
- Albero in acciaio INOX AISI 304

Per informazioni tecniche, foto e prezzi aggiornati visita il nostro sito www.cillisrl.com

GIRANTE ELETTROPOMPA IN ACCIAIO

Articolo		€ Listino	
6000425G	ALE 25	35,00	1
6000430G	ALE30	35,00	1
6000440G	ALE40	35,00	1

GIRANTE ELETTROPOMPA IN OTTONE

Articolo		€ Listino	
6000520G		35,00	1
6000527G		35,00	1

SERIE GUARNIZIONI 20



Articolo		€ Listino	
6000513		15,10	1

• Ricambio per elettropompe: 6000520-6000527

RACCORDI DIAMETRO 20 x 1/2"



Articolo		€ Listino	
6000519		14,00	1

• Ricambio per elettropompa da 20 travaso (6000520).

ELETTROPOMPA AUTOADESCANTE BISENSO

Articolo	Ø	Hp	€ Listino	
6000540	40	1,2	169,00	1

CARATTERISTICHE

Potenza	900 W
Altezza max	16 m
Prevalenza max	75 l/ora



ELETTROPOMPA TRAVASO BISENSO ACCIAIO AISI 304 CON RACCORDI USO ALIMENTARE



Girante in acciaio
Inox AISI



Articolo	Ø	Hp	€ Listino	
6000523	20	0,5	160,00	1

GIRANTE PER S20 INOX AISI



Articolo	€ Listino	
6000563	43,20	1

• Ricambio per elettropompa da 20 travaso 6000523

COMPENSATORE UF 450V



Articolo	€ Listino	
6000567	10,80	1

• Ricambio per elettropompa da 20 travaso 6000523

COPRIVENTOLA 4 FORI



Articolo	€ Listino	
6000564	6,48	1

• Ricambio per elettropompa da 20 travaso 6000523

CARATTERISTICHE

Volt	230
Prevalenza max	33 l/min
Attacchi filettati	G 3/4"
Attacchi portagomma	15 mm
Raccordi diametro	20

• Non adatta al latte

BASE FMA FILETTATA

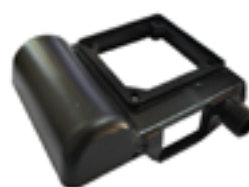

Articolo	€ Listino	
6000565	3,96	1

• Ricambio per elettropompa da 20 travaso 6000523

COPERCHIO E4



Articolo	€ Listino	
6000566	4,68	1

• Ricambio per elettropompa da 20 travaso 6000523

OR 81X2 NBR



Articolo	€ Listino	
6000562	2,88	1

• Ricambio per elettropompa da 20 travaso 6000523

Per informazioni tecniche, foto e prezzi aggiornati visita il nostro sito www.cillisrl.com

**CARRELLO MULTIUSO UNIVERSALE
ACCIAIO ZINCO**



Gancio portacavo



Articolo	Lcm	€ Listino	
9702000	36x20xh98	130,00	1

•Carrello in acciaio zincato, può trasportare pompe per irrorazione, elettropompe, batterie. CON RUOTE ANTIFORO. PREZZO RIFERITO AL SOLO CARRELLO

Esempi di applicazione:

PISTOLA



Articolo	Ø	€ Listino	
6002180	19	15,20	6

**TRAVASATORE A SOFFIO
RUBINETTO A FARFALLA**

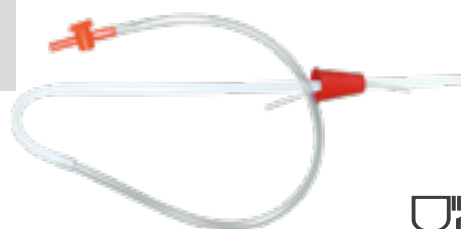

Articolo	€ Listino	
0023500	5,40	10

**TRAVASATORE A POLMONE
RUBINETTO A FARFALLA**



Articolo	€ Listino	
0024500	6,86	10



**TRAVASATORE EASY
BIG 56CM**



Articolo	€ Listino	
0024514	16,20	10

**TRAVASATORE EASY
MAXI 62CM**



Articolo	€ Listino	
0024516	19,20	10

**TUBO RIGIDO
PER TRAVASATORE EASY**



Articolo	Lcm	€ Listino	
0024520	44	2,98	20

• Accessorio ideale per l'imbottigliamento. Grazie alla valvola con apertura a pressione rende l'imbottigliamento molto veloce. Ideale per la birra..

LEVAOLIO POLITENE



Articolo	€ Listino	
0049500	3,30	12

CARAFFE GRADUATE PER OLIO



Articolo	Lt	€ Listino	
0045600	2	9,40	12
0045650	5	12,50	12

CARAFFE GRADUATE



Articolo	Lt	€ Listino	
0046030	3	4,06	10
0046050	5	4,70	8

ALZAVINO POLIETILENE



Articolo	€ Listino	
0051110 Standard	6,39	12

• Per prelievo liquido.

PROVETTE E CILINDRI



Articolo	Tipo	€ Listino	
0044500	100 cc	5,13	12
0045000	250 cc	5,67	6
0045500	500 cc	6,84	6

DOSATORI GRADUATI



Articolo	Lt	€ Listino	
0045510	0,1	0,33	500
0045520	0,25	0,39	500
0045525	0,25 extra	0,54	500
0045530	0,5	0,81	500
0045540	1	1,02	160
0045545	2	2,25	160

SESSOLA ATOSSICA



Articolo	Lcm	€ Listino	
0046105	19	1,06	12
0046108	24	1,24	12
0046110	29	1,58	12
0046120	34	1,93	12
0046130	38	2,28	12
0046140	42	2,63	12

Per informazioni tecniche, foto e prezzi aggiornati visita il nostro sito www.cillisrl.com

SESSOLA PIANA



Articolo	Lcm	€ Listino	
0046100	22	3,00	12

COLALATTE



Articolo	Lcm	€ Listino	
0037300	25	11,16	24
0043000	Filtro ricambio Ø 10,5	2,50	72
0043200	Filtro Inoxricambio Ø 12,5	4,50	72

IMBUTI A GAMBO ESAGONALE CON FILTRO



Articolo	Ø	€ Listino	
0040515	15	2,28	72
0040521	21	3,10	72
0040525	25	5,44	72
0040530	30	6,80	36

FILTRI IMBUTI



Articolo	Ø	€ Listino	
0042500	7,5	1,92	72
0043200	12,5	4,50	36

IMBUTI A VORTICE



Articolo	€ Listino	
0032500	6,00	12

IMBUTO CON CURVA FLESSIBILE CON FILTRO



Articolo	Ø	€ Listino	
9914115	25	7,70	12

IMBUTO AUTOREGOLATORE



Articolo	€ Listino	
0031500	2,80	48

SET 4 PEZZI IMBUTI



Articolo	Ø	€ Listino	
9884024	5-7,5-10-12,5	1,70	72

TEE A 90° PLASTICA ALIMENTARE



Articolo		€ Listino	
1905170	3/4"	2,82	6

RACCORDO 3 PEZZI NYLON



Articolo		€ Listino	
6120076	1" 1/2 x 40	10,88	4

RACCORDO DRITTO NYLON



Articolo	Ø	Filetto Gas	€ Listino	
1905150	20	3/4"	0,95	100

RACCORDO PORTAGOMMA NYLON



Articolo	Ø	Filetto Gas	€ Listino	
1905105	20	3/4"	0,56	100
1905108	20	1"	0,62	100
1905110	25	1"	0,66	100
1905115	30	1"	0,78	50
1905118	30	1.¼"	0,99	50
1905120	35	1.¼"	1,05	50
1905125	40	1.½"	1,40	50
1905130	50	2"	1,86	50
1905135	60	2"	2,40	20

RACCORDO CURVO NYLON



Articolo	Ø	Filetto Gas	€ Listino	
1905160	20	3/4"	1,47	100

GIUNTO 3 PEZZI NYLON



Articolo	Ø	Ø	€ Listino	
1908120	20	20	1,59	100
1908125	25	25	1,70	100
1908130	30	30	2,08	50
1908135	35	35	2,49	50
1908140	40	40	2,70	50
1908150	50	50	4,58	50
1908160	60	60	5,85	50

RACCORDI 3 PEZZI CURVO NYLON



Articolo	Ø	Filetto Gas	€ Listino	
1902103	20	3/4"	1,88	100
1902105	20	1"	1,90	100
1902110	25	1"	2,26	50
1902115	30	1"	2,80	50
1902120	35	1.¼"	3,34	50
1902122	40	1.¼"	4,06	50
1902125	40	1.½"	4,06	50
1902128	50	1.½"	5,70	30
1902135	50	2"	6,08	30

Per informazioni tecniche, foto e prezzi aggiornati visita il nostro sito www.cillisrl.com

RACCORDI 3 PEZZI DRITTO NYLON



Articolo	Ø	Filetto Gas	€ Listino	
1901103	20	3/4"	1,62	100
1901105	20	1"	1,68	100
1901110	25	1"	1,77	100
1901115	30	1"	2,04	50
1901118	30	1.¼"	2,41	50
1901120	35	1.¼"	2,72	50
1901122	40	1.¼"	2,93	50
1901125	40	1.½"	2,93	50
1901128	50	1.½"	4,32	50
1901135	50	2"	4,51	30
1901138	60	2"	5,54	30

CESTINO DI FONDO

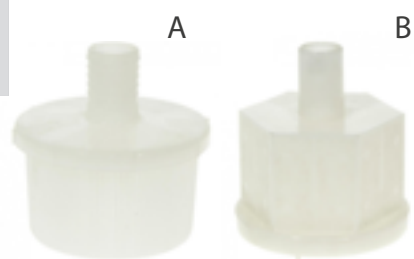

Articolo	Ø mm	€ Listino	
0180015	15 A	2,40	25
0180020	20 A	2,52	25
0180025	25 A	2,60	25
0180026	25 B	3,42	25
0180030	30 B	3,48	12
0180035	35 B	6,00	12
0180040	40 B	6,60	12

RUBINETTO A SFERA CON BECCUCCIO



PRO

Articolo	Ø	€ Listino	
1922010	3/8"	5,06	100
1922020	1/2"	5,50	100
1922030	3/4"	8,28	100

• Rubinetto a sfera in ottone cromato, maniglia a leva in metallo.

RUBINETTO CURVO ACCIAIO INOX



INOX PRO

Articolo	Ø	€ Listino	
1922220	3/8"	17,16	12
1922210	1/2"	17,20	12
1922205	3/4"	23,00	6
1922203	1"	27,30	6

• Rubinetto a sfera riempibottiglie in acciaio inox con maniglia a leva in acciaio inox.

RUBINETTO INOX 3/8" MINI



INOX PRO

Articolo	Ø	€ Listino	
1922300	3/8"	13,00	12
1922350	1/2"	18,00	12

GHIERA PER RUBINETTO A SFERA



PRO

Articolo	Ø	€ Listino	
1922015	3/8"	1,60	50
1922025	1/2"	1,80	50
1922035	3/4"	2,20	50
1922045	1"	2,46	50

GUARNIZIONE ATOSSICA PER RUBINETTO A SFERA



Articolo	Ø	€ Listino	
1922018	3/8"	0,324	100
1922028	1/2"	0,30	100
1922038	3/4"	0,40	100
1922048	1"	0,44	100

RUBINETTO A SFERA ENOLOGICO CON PORTALUCCHETTO



Articolo	N°	Ø	Lmm	€ Listino	
1925010	12	A 20 - B 23	C 43	17,18	8
1925020	14	A 21 - B 24	C 43	17,18	8
1925030	16	A 22 - B 27	C 50	18,50	8
1925040	18	A 23 - B 30	C 52	20,00	8

RUBINETTO CONICO PER BOTTE CON PORTALUCCHETTO



Articolo	N°	Ø	Lmm	€ Listino	
1925050	3	A 16 - B 21	C 43	16,80	8
1925060	4	A 23 - B 27	C 46	19,40	6
1925070	5	A 23 - B 26	C 47	21,00	8
1925080	6	A 23 - B 30	C 52	26,00	6
1925090	7	A 28 - B 33	C 65	28,00	5
1925100	8	A 28 - B 33	C 65	33,00	2

RUBINETTO CONICO PER BOTTE LEGNO



Articolo	N°	Ø	Lmm	€ Listino	
1925110	8	A 13 - B 16	C 38	8,14	12
1925120	10	A 15 - B 18	C 41	11,80	12

RUBINETTO ASSAGGIAVINO PER BOTTE



Articolo	€ Listino	
1925130	8,20	15

VALVOLA A SFERA PN25 1" COMPLETO DI CURVA DI PLASTICA + GIRELLO DN30



Articolo	€ Listino	
1922040	29,00	12

VALVOLA NYLON ENOLOGIA ALIMENTARE



Articolo	Attacco	€ Listino	
1924025	1" passo lungo	9,22	10
1924030	3/4"	7,70	10
1924040	1/2"	6,82	10

VALVOLA NYLON

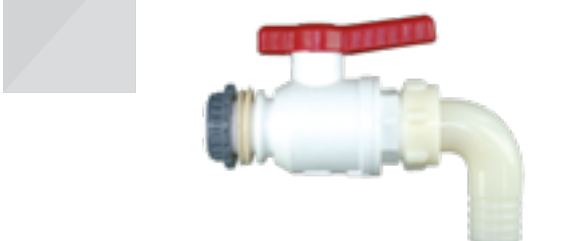

Articolo	Attacco	Tube	€ Listino	
1924010	1"	Ø 30	6,60	10
1924008	3/4"	Ø 25	6,05	10

Per informazioni tecniche, foto e prezzi aggiornati visita il nostro sito www.cillisrl.com

RUBINETTO 1/2"



Articolo	€ Listino	
5403050	2,46	50

RUBINETTO 3/4" VINO E BIRRA CON ANTISEDIMENTO



Articolo	€ Listino	
5403052	2,80	50

FILTRO PER VALVOLA 1"



Articolo	€ Listino	
1924050	6,27	60

TAPPO IDRAULICO CLASSICO



Articolo	Lt	€ Listino	
0049000	35	1,16	72
0048500	54	1,20	72

• Per fermentazione e stoccaggio del vino in damigiana

TAPPO IDRAULICO CON PARAPOLVERE



Articolo	Lt	€ Listino	
0048600	54	1,46	72

• Per fermentazione e stoccaggio del vino in damigiana, con parapolvere

COLMATORI PER BOTTI



Articolo	Tipo	€ Listino	
0050500	Grande	8,98	12
0050510	Piccolo	8,98	12

MINI FERMENTATORE CON CALOTTA E GOMMINO AIR LOCK A SPIRALE TIPO S



Articolo	Lt	€ Listino	
0049200	35	2,28	72
0048700	54	2,38	72

• Per fermentazione e stoccaggio del vino in damigiana

TERMOMETRO CON GABBIA PVC



Articolo	Lmm	€ Listino	
5190210	340	10,00	12

• Termometro con gabbia di protezione e occhiello superiore per gancio.
Scala da -10°C a 120°C
Lunghezza 34 cm.

**TERMOMETRO
BASE LEGNO**



Articolo	Lmm	€ Listino	
5190250	350	10,00	12

• Scala da -10°C a 120°C

**TERMOMETRO CASA BASE PLASTICA
-30° + 50°**



Articolo	Lcm	€ Listino	
9824261	22	1,20	12

TERMOMETRO CASA BASE FAGGIO -15° + 60°



Articolo	Lcm	€ Listino	
5190350	24	5,05	12

**MOSTIMETRO BABO
MISURATORE ZUCCHERO**

• Questo strumento serve a determinare il contenuto di zucchero nelle uve. Da questo valore si può determinare il futuro valore di grado alcolico del vino.



Articolo	Tipo	€ Listino	
5190010	Tascabile	5,00	10
5190011	Tascabile blister	6,00	10
5190030	Con termometro	10,40	10
5190031	Con termometro blister	12,00	10

**GLEUCOMETRO GUYOT A 3 SCALE
MISURATORE ZUCCHERO, ALCOOL, BAUME'**



Articolo	Tipo	€ Listino	
5190060	Da banco con termometro	8,00	10
5190080	Tascabile	4,00	10
5190081	Tascabile blister	4,50	10

Questo strumento consente di determinare con sufficiente precisione la densità, la quantità di zucchero e il grado alcolico del vino che si otterrà dal mosto in esame.

**ALCOLOMETRO DA BANCO
CON TERMOMETRO**



Articolo	Tipo	€ Listino	
5190100		12,00	10
5190101	Blister	12,50	10

• L'alcolometro è uno strumento che serve a misurare la quantità percentuale di alcol etilico presente nei distillati.

**VINOMETRO TIPO BERNADOT
MISURA LA GRADAZIONE DEL VINO**



Articolo	€ Listino	
5190120	3,00	12

• Questo strumento serve a determinare il grado alcolico del vino. Funziona al principio della diversa forza capillare del vino a seconda del suo contenuto alcolico. E' costituito da un tubo capillare ed imbuto che serve da piedistallo durante il funzionamento

TERMOMETRO PER VINO



Articolo	€ Listino	
5190155	3,00	12

• Scala da 0°C a 40°C

SET 100 PEZZI TAPPI SUGHERO



Articolo	Lmm	€ Listino	
5600100	26x40	9,00	20
5600350	30x40	11,40	20

Per informazioni tecniche, foto e prezzi aggiornati visita il nostro sito www.cillisrl.com

SET 100 TAPPI EXTRA AGGLOMERATO DI SUGHERO



Articolo	Lmm	€ Listino	
5600055	23x38	11,00	25

SET 100 TAPPI SINTETICI VINO IN BUSTA



Articolo	Lmm	€ Listino	
0007000	23x38	10,53	35

SET 50 TAPPI SUGHERO CONICO



Articolo	€ Listino	
5600410	4,60	60

CONFEZIONE 50 TAPPI SINTETICO CONO LISCIO COLORI ASSORTITI



Articolo	Lmm	€ Listino	
0007510	35x20x17	8,14	12

BLISTER 6 PZ TAPPOTUTTO ONDA



Articolo	Lmm	€ Listino	
0007505	35x23x17	3,77	25

SET 100 TAPPI GRAPPA



Articolo	Lmm	€ Listino	
5600500	19	11,40	10

SET 100 TAPPI ORO GRAPPA



Articolo	Lmm	€ Listino	
5600503	19	34,50	20

BONDE SUGHERO PER DAMIGIANA



Articolo	Lt	€ Listino	
5600445	35	0,69	25
5600455	54	0,76	25

SET 100 CAPSULE TERMORETRAIBILI



Articolo	Lmm	Colore	€ Listino	
0007020	31x55	Verde	6,12	60
0007023	31x55	Rosso	6,12	60
0007025	31x55	Oro	6,12	60

SET 100 TAPPI ALETTATI BIANCHI



Articolo	€ Listino	
0007010	5,04	40

SET 100 GABBETTE 4 FILI PER TAPPI



Articolo	€ Listino	
0007015	5,04	40

GIRAGABBETTE

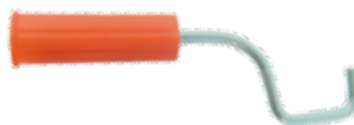

Articolo	€ Listino	
0009000	3,72	12

TAPPO VERSATORE PER BOTTIGLIE



Articolo	€ Listino	
5600430	1,22	50

• Prezzo riferito ad un solo tappo. Colori assortiti non a scelta.

SET 100 TAPPI CORONA



Articolo	Ø	Colore	€ Listino	
5601555	26	Gold	1,40	10
5601557	26	Rosso	1,56	10

• Tappo corona con guarnizione in plastisol idoneo alla bollitura.

SET 100 CAPSULE PER BARATTOLI



Articolo	Ø	€ Listino	
5601562	53	6,58	18
5601565	63	7,82	13
5601568	70	9,82	10
5601571	82	10,72	7

SET 10 CAPSULE PER BARATTOLI



Articolo	Ø	€ Listino	
5601574	110	3,04	25

Per informazioni tecniche, foto e prezzi aggiornati visita il nostro sito www.cillisrl.com

TAPPATRICE A COLONNA REGINA A 3 LEVE

• Tappatrice per tappi corona con regolazione di altezza rapida e leva singola. Utile per tappare bottiglie di birra, passata di pomodoro, ecc.



Articolo	€ Listino	
0016504	35,12	6



TAPPATRICE A COLONNA 1 LEVA CORONA



Articolo	€ Listino	
0016502	21,84	6

• Tappatrice per tappi corona con regolazione di altezza manuale. Chiude tappi fino a 3cm.

ADATTATORE PER TAPPI CORONA 2 LT



Articolo	Ø	€ Listino	
0015511	30	3,90	12

• Accessori per la tappatrice 0016502

TAPPATRICE TAPPI CORONA A 2 LEVE



Articolo	€ Listino	
0015505	13,12	6

TAPPATRICE A 2 LEVE PER SUGHERO



Articolo	€ Listino	
0015510	17,60	6

• Tappatrice a due leve per tappi in sughero Ø 2,4 cm; altezza 3,3 cm; Ø 2,4 cm; altezza 3,8 cm. (Non è possibile utilizzare tappi di Ø superiore a 2,6 cm).

TAPPATRICE SUGHERO ALTA PROFESSIONALE



Articolo	€ Listino	
0015500	104,00	3

• Ganasce in nylon ad alta resistenza per uso alimentare



CAPSULATORE ORIZZONTALE 220V PER CAPSULE TERMORETRAIBILI



Articolo	€ Listino	
0003020	174,63	1

CAPSULATORE VERTICALE 220V PER CAPSULE TERMORETRAIBILI



Articolo	€ Listino	
0003025	356,19	1

SPAZZOLINO LAVABOTTIGLIE



Articolo	Lcm	€ Listino	
0005055	47	1,10	30

SCOVOLO MANICO LEGNO



Articolo	Lcm	€ Listino	
0005050	43	1,00	24

• Lunghezza solo spazzola: 25cm

LAVATUTTO LAVA FACILE 35 CM



Articolo	€ Listino	
0005005	63,00	1

LAVATUTTO LAVA FACILE 60 CM



Articolo	€ Listino	
0005008	64,50	1

LAVA DAMIGIANE

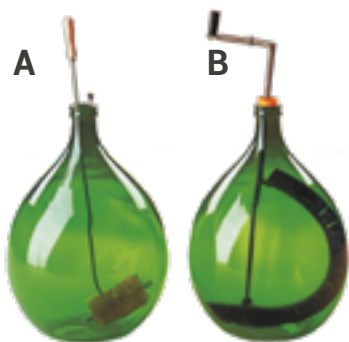

Articolo	Tipo	€ Listino	
0011000	A	26,00	10
0009500	B	63,04	6

SET 2 SCOLABOTTIGLIE EASY DRAINER 50/32 SENZA BACINELLA

- Scola velocemente
 - Sovrapponibile fino a 7 piani
 - Stoccaggio salvaspazio
 - Riciclabile 100%
 - Plastica alimentare
 - 2 ripiani portabottiglie da 16/25 posti
- (32 bottiglie da vino oppure 50 da birra da 0,33 Cl)

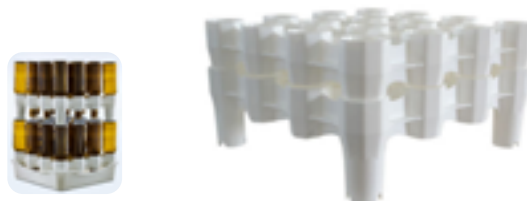

Articolo	€ Listino	
0004006	23,16	6

SCOLABOTTIGLIE EASY DRAINER 50/32 CON BACINELLA



Articolo	€ Listino	
0004003	29,71	6

- Scola velocemente
- Sovrapponibile fino a 7 piani
- Stoccaggio salvaspazio
- Riciclabile 100%
- Plastica alimentare

SCOLA BOTTIGLIE 80 POSTI

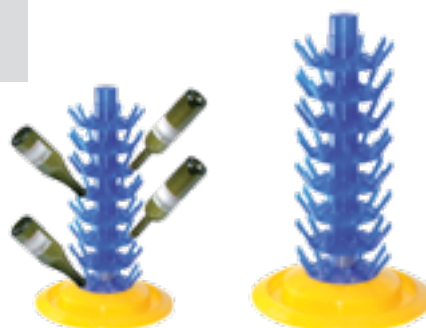

Articolo	Tipo	€ Listino	
0004000	80 posti	15,16	12

- Completamente smontabile in confezione singola, solida e funzionale

CILLI TEK III

**OLIO ENOSET EXTRA FU15 VASELINA
ALTISSIMA QUALITA'**

• Olio di vasellina ad altissima raffinazione, incolore, inodore e insapore. Rispondente alle norme di purezza previste dalle farmacopee di vari paesi. Soddisfa i più severi requisiti di purezza richiesti per contatti alimentari, impiego farmaceutico e cosmetico.



Articolo	Lt	€ Listino	CFM
5180005	1	7,80	20



CILLI TEK III

**OLIO ENOLOGICO EXTRA FU VASELINA
ALTISSIMA QUALITA'**



Articolo	Lt	€ Listino	CFM
5180008	1	7,00	20

• Olio di vasellina ad altissima raffinazione, incolore, inodore e insapore. Rispondente alle norme di purezza previste dalle farmacopee di vari paesi. Soddisfa i più severi requisiti di purezza richiesti per contatti alimentari, impiego farmaceutico e cosmetico.

**ENOBISOLFITO REGOLATORE
SPECIFICO DELLE FERMENTAZIONE**



Articolo	Kg	€ Listino	CFM
5180705	0,250	2,25	100

• L'anidride solforosa aggiunta con ENOBISOLFITO permette un'azione antiossidante sul mosto e soprattutto inibisce i lieviti selvaggi, in particolare quelli dalle caratteristiche enologiche meno valide, favorendo una fermentazione in purezza. Ideale perciò risulta l'inoculo del mosto con lieviti selezionati a buona attitudine enologica.

LIEVITO EZFERM GR 50



Articolo	€ Listino	CFM
5181505	4,40	30

• Lievito selezionato per vinificazione per un rapido avvio e completamento della fermentazione alcolica. Produzione di vini bianchi e rossi ad alto contenuto zuccherino. Cura e prevenzione degli arresti di fermentazione.

LAVA BOTTIGLIE IDRAULICO



Articolo	Tipo	€ Listino	CFM
0005000	Lavabottiglie	70,00	4
0005010	Scovolo ricambio	18,78	10

**LIEVITO CEREVISIAE
LIEVITO SELEZIONATO PER VINIFICAZIONE**



Articolo	Kg	€ Listino	CFM
5180800	0,075	7,26	120

• Lievito secco senza aggiunta di sostanze estranee. Coltura selezionata di Saccaromy cerevisiae

ATTIVANTE DI FERMENTAZIONE



Articolo	Kg	€ Listino	CFM
5180900	0,100	1,68	120

• Sali minerali e vitamine per la fermentazione alcolica di uve bianche e rosse.
Ammonio solfato 40,4% ; Fibra di cellulosa 24,2% ; Ammonio fosfato bibasico 20,1% ; Bentonite 15,2% ; Tiamina cloridrato (vitamina B) 0,1%

Per informazioni tecniche, foto e prezzi aggiornati visita il nostro sito www.cillisrl.com

BENTONITE PLUXBENTON PER MOSTO E VINO



Articolo	Kg	€ Listino	
5180325	1,000	6,20	25

Composizione: Bentonite pura

Applicazione:

PLUXBENTON possono essere impiegate su mosto, durante la fermentazione e su vino.

Su mosto: riducono il contenuto delle proteine responsabili dell'instabilità chimico-fisica del vino; consentono una adeguata pulizia, condizione indispensabile per l'ottenimento di vini di qualità;

- inattivano gli enzimi ossidasici, quali tirosinasi e laccasi, che possono compromettere la qualità del vino. L'impiego di PLUXBENTON N risulta perciò particolarmente importante nel caso di mosti provenienti da uve bottrizzate.

In fermentazione: favoriscono un processo fermentativo regolare e completo e l'ottenimento a fine fermentazione di un vino limpido con fecce compatte. Su vino: assicurano la stabilizzazione proteica a dosaggi contenuti e contribuiscono alla chiarificazione del vino.

REPLICAR BIANCHI CHIARIFICANTE PER USO ENOLOGICO



Articolo	Kg	€ Listino	
5181100	0,100	2,25	150

Composizione:

Bentonite 50%; Caseinato di potassio 30%; Silice colloidale 10%; Polivinilpirrolidone 2%

ENOCONSERVATORE PREPARATO PER MANTENERE SANI I VINI

Composizione:

Bicarbonato di potassio 37%; Potassio metabisolfito 25%; Caseinato di potassio 10%; Acido L-ascorbico (vitamina C) 10%; Silice colloidale 10%; Bentonite 5%; Acido metatartarico 3%

Articolo	Kg	€ Listino	
5181200	0,100	3,60	30



RIDUCENT ANTISSIDANTE



Articolo	Kg	€ Listino	
5181300	0,100	4,42	100

Composizione:

Potassio metabisolfito 35,7%; Acido citrico anidro 35,7%; Acido L-ascorbico (Vitamina C) 25%; Acido metatartarico 3,6%

Aspetto: polvere bianco- beige con debole odore di anidride solforosa.

Prodotto particolarmente indicato per il trattamento dei vini ossidati e per un'efficace prevenzione ossidativa. Consente di recuperare i vini affetti da casse, favorendo l'eliminazione di odori anomali ridando freschezza ai vini. Esplica undoppio effetto antiossidante ed anticasse, dovuto alla inibizione degli enzimi ossidasici presenti, ad opera dell'acido ascorbico e dell'anidride solforosa. Esplica inoltre un effetto stabilizzante, grazie alla caseina e all'anidride solforosa, nei confronti delle sostanze coloranti.

MODALITA' D'USO

Sciogliere il prodotto in acqua al 10% ed aggiungere al vino sotto agitazione. A seconda del vino da trattare, può essere utile eseguire il trattamento in associazione con bentonite, da impiegare dopo il RIDUCENT. Filtrare a chiarificazione ultimata ed evitare successivi arieggiamenti al vino.

DISACIDANTE

Preparato per correggere l'eccesso di acidità
 Composizione:
 Potassio bicarbonato 70% ; Calcio carbonato 22% ;
 Potassio tartrato neutro 5% ; Bentonite 3%



Articolo	Kg	€ Listino	
5181400	0,100	1,45	120

METABISOLFITO DI POTASSIO

Inibente selettivo di fermenti indesiderati

APPLICAZIONI

Solfitazione di mosti e vini

Composizione: Potassio metabisolfito (E224) 100%

CARATTERISTICHE GENERALI E QUALITATIVE

Aspetto: polvere cristallina bianca, con odore caratteristico di anidride solforosa.

Additivo indispensabile in enologia per le sue molteplici funzioni.

E' in grado di esplicare una funzione solubizzante di polifenoli, antimicrobica verso la microflora indesiderata, acidificante, antiossidasica verso gli enzimi ossidasici, antiossidante.



Articolo	Kg	€ Listino	
5181490	0,100	1,04	100
5181500	0,250	2,70	80
5181510	1,000	5,98	20

CARATTERISTICHE

Titolo	%S02 > 56
Titolo	%K2S2O5 > 97.2
Solfati	%K2SO4 Complemento a 100%
Tiosolfati	%K2S2O5 < 0.04
Ferro	% come Fe < 0.001
Metalli pesanti	% come Pb < 0.001
Selenio	% come Se < 0.0005
Arsenico	% come As < 0.0003
Piombo	% come Pb < 0.0005
Mercurio	% come Hg < 0.0001

CARATTERISTICHE CHIMICO-FISICHE

Formula	K2S2O5
Peso molecolare	222.33
Sinonimi	Potassio bisolfito anidro, potassio bisolfito, potassio disolfito.
Densità apparente	1.0-1.3 Kg/dm3 ca

Per informazioni tecniche, foto e prezzi aggiornati visita il nostro sito www.cillisrl.com

ACIDO CITRICO CONSERVATIVO ANTIOSSIDANTE



Articolo	Kg	€ Listino	
5181600	0,100	1,00	50
5181610	1,000	6,50	25

APPLICAZIONI

L'ACIDO CITRICO è un valido complessante del ferro, con il quale forma complessi solubili, prevenendo così intorbidamenti e precipitazioni causati da questo metallo (casse ferrica, etc.) Questa proprietà permette anche di svolgere un'azione sinergizzante nella protezione dalle ossidazioni.

Nel vino e nei mosti l'apporto di ACIDO CITRICO innalza l'acidità fissa insufficiente. un adeguato tenore di acidità è molto importante per la conservabilità del vino e per prevenirne le malattie.

Composizione: Acido citrico

CARATTERISTICHE GENERALI

Aspetto: polvere cristallina bianca o incolore, inodore.

CARATTERISTICHE CHIMICO-FISICHE

Formula C6H8O7	C6H8O7H2O
Ceneri solfatate	% <0.05 <0.05
Titolo	% sul secco <99.5 <99.5
Metalli pesanti	(mg/kg Pb) < 1 < 1
Piombo	(mg/kg Pb) < 1 < 1
Arsenico	(mg/kg As) < 1 < 1
Mercurio	(mg/kg Hg) < 1 < 1

Prodotto conforme alle caratteristiche richieste da:

DM 26/04/69 (sostanze per uso enologico)

DIR 96/77/CE /Additivi alimentari)

Prodotto per uso enologico, secondo quanto previsto da:

Regolamento CE 1493/99

ACIDO TARTARICO SALE PURISSIMO

Composizione: E 334 Acido L(+) tartarico puro di origine agricola.

Applicazione:

Per la correzione dell'acidità di mosti e vini.

Articolo	Kg	€ Listino	
5180315	1,000	32,70	10



TREFOSOLFINA

APPLICAZIONI:

Svolge nel mosto un'azione antiossidante, favorisce la selezione di lieviti indigeni a metabolismo anaerobico e la predominanza dei lieviti selezionati.

Contemporaneamente, esplica un'azione chiarificante che consente di ottenere, a fine fermentazione, vini più limpidi e stabili.

Composizione: E224 metabisolfito di potassio 70% ; Bentonite polvere 25% ; Ammonio fosfato bibasico 5%

Articolo	Kg	€ Listino	
5181705	0,200	3.08	100



DETERGENTE DETERBEN FLACONE



Articolo	Kg	€ Listino	
5180070	1,000	4,12	20

Detergente a bassa schiuma, non profumato.
Composizione:

Benzalconio cloruro 4% ; Alcool grasso policondensato ; Carbonato di sodio ; Non contiene fosfati ; Biodegradabilità 90% minimo.

DETERGENTE NEOSAN



Articolo	Kg	€ Listino	
5180075	1,000	4,50	25

NEOSAN è un detersivo alcalino a largo spettro che viene impiegato per il lavaggio manuale o con macero delle bottiglie, per la pulizia nell'industria alimentare ed enologica (vasche, botti, ecc..)

ENOPLASTICO PER SIGILLARE FUSTI E VASCHE



Articolo	Kg	€ Listino	
5180100	0,500	4,06	40

Pasta semisolida di colore bianco crema, inodore e impermeabile. Composto a base di sostanze grasse di elevata purezza e di polveri adesive. Non non irrancidisce nè ammuflisce.

TANNISOL TUBETTO DA 10 PASTIGLIE

1 Pezzo equivale ad un tubetto.
Composizione:Potassio metabisolfito (E224) 95%
TANNISOL previene e cures le malattie delle casse, del girato e del filante; preserva il vino dalle alterazioni ossidative, mantenendo inalterati e brillanti i vini chiarificati e filtrati.

Articolo	Kg	€ Listino	
5180500	0,100	3,18	100

DETERGENTE SEPTOSAN



Articolo	Kg	€ Listino	
5180085	1,000	4,92	20

Detergente cloro sanificante SEPTOSAN lava e sanifica in una sola operazione, perchè è un energetico detergente con elevata azione DECOLRANTE, DEODORANTE e SATIFICANTE, data dall'alta percentuale in cloro attivo (650 p.p.m in soluzione all'1%). DOSI: 0.5-4% diluito in acqua. Usando acqua tiepida, l'azione è intensificata. Sciacquare dopo l'uso.

DETERGENTE SODA CAUSTICA A SCAGLIE



Articolo	Kg	€ Listino	
5180080	1,000	4,22	25

Composizione:
Racc CEE 89/542 Inferiore a 5% poliacbossilati ; Superiore a 30% idrossido di sodio. Non contiene fosforo (P). Non contiene tensioattivi. Non soggetto alla L.26/04/83 n°136 sulla biodegradabilità

ZOLFO DISCHI



Articolo	Kg	€ Listino	
5180200	1,000	21,40	5

Dischi antigocciolanti per la disinfezione dei fusti.
Modalità d'uso: infilare gli zolfini su un ferro piegato a uncino. Dare fuoco e introdurre nella parte superiore del fusto o della vasca.



Per informazioni tecniche, foto e prezzi aggiornati visita il nostro sito www.cillisrl.com

ANTIFLOR PASTIGLIE GALLEGGIANTI ANTIFLORETTA.

Le pastiglie Steryl sono galleggianti a fior di liquido ed emanano lentamente il principio attivo che rende sterile l'aria sovrastante. Grazie all'azione dell'isosolfocianato d'allile il vino è protetto da altre alterazioni batteriche ed enzimatiche a carattere ossidativo che si manifestano sulla superficie dei vini. Steryl sostituisce l'impiego dei tappi colmatori e la pratica oggi vietata dell'olio di vasellina.



Articolo	gr	Pz	Tipo	€ Listino	
5180300	1	480	Damigiane	62,00	1
5180305	7	80	Fusti	78,00	1

DAMIGIANA INOX EXTRA

Il fusto graffiato per olio fa parte dei contenitori e recipienti per olio e altri liquidi, in acciaio inox e con chiusura ermetica. Questo recipiente ripropone il design dei tradizionali contenitori italiani e garantisce una perfetta conservazione del liquido contenuto. È ideale anche per lo stoccaggio di succhi di frutta, tè, acqua, aceto etc.

INOX

Articolo	Lt	€ Listino	
5240050	50	74,80	3
5240100	100	125,12	1



KIT SOSTEGNO UNISUPER REGOLABILE

CILLITEK III



BREVETTATO

Articolo	Kg	Ø	€ Listino	
5060510	200 max	380-500 mm	34,00	6
5060515	500 max	500-700 mm	47,00	6
5060520	800 max	700-980 mm	73,00	6

Un unico sostegno adattabile a più misure di fusti.
Completo di dadi e bulloni per il montaggio.
Altezza 350 mm

GREMBIULE PVC ANTISTRAPPO



Articolo	Lmm	Colore	€ Listino	
3141785	75x110	Verde	4,30	20
3141790	90x120	Verde	4,70	20
3141810	90x120	Bianco	4,70	20

UBURG **FORBICE DA POTATURA INOX**



INOX

Articolo	Lmm	€ Listino	
9700604	170	7,30	24

UBURG **FORBICI POTATURA IN ALLUMINIO A BATTUTA**



Articolo	Lmm	€ Listino	
9170018	210	22,00	10

UBURG **FORBICE DA POTATURA INOX**



INOX

Articolo	Lmm	€ Listino	
9700605	200	8,00	24

UBURG **FORBICE UNIVERSALE INOX**



INOX

Articolo	Lmm	€ Listino	
9700602	200	7,00	30

UBURG **FORBICI POTATURA IN ALLUMINIO A BATTUTA**



Articolo	Lmm	€ Listino	
9170020	210	23,00	10

UBURG **FORBICI POTATURA**



Articolo	Lmm	€ Listino	
9170022	180	8,00	20

UBURG **FORBICI POTATURA IN ACCIAIO INOX**



INOX

Articolo	Lmm	€ Listino	
9170024	180	10,00	10

Per informazioni tecniche, foto e prezzi aggiornati visita il nostro sito www.cillisrl.com



FORBICI POTATURA LAMA FLOTTANTE



Articolo	Lmm	€ Listino	
9170026	225	14,00	10
9170026A	Coppia gommini	0,80	1
9170026B	Molla ricambio	0,50	1



RICAMBI:



9170026A



9170026B



FORBICI POTATURA 21 CM



Articolo	Lmm	€ Listino	6 box
9170028	210	14,50	10



FORBICE COGLIFRUTTA



Articolo	Lmm	€ Listino	
9170027	180	7,00	20



FORBICI COGLIUVA



Articolo	Lmm	€ Listino	
9170029	190	7,00	20





FORBICE A PUNTA DRITTA INOX



INOX

Articolo	Lmm	€ Listino	
9161380	190	4,00	100
9161655	Molla ricambio	0,50	100



FORBICE A PUNTA DRITTA



Articolo	Lmm	€ Listino	
9161385	190	3,33	100
9161655	Molla ricambio	0,50	100



FORBICE A PUNTA CURVA INOX



INOX

Articolo	Lmm	€ Listino	
9161390	190	4,00	120
9179060	Molla ricambio	0,50	100



FORBICE AGRUMI A PUNTA CURVA



Articolo	Lmm	€ Listino	
9161560	160	3,50	120



FORBICE INOX CON CINTURINO

INOX

Articolo	Lmm	Tipo	€ Listino	
9161610	165	Busta	2,50	120
9161620	165	Doppio blister	2,70	120



FORBICE INOX CON CINTURINO

INOX

Articolo	Lmm	Tipo	€ Listino	
9161505	190	Doppio blister	3,80	120



FORBICE COGLIUVA INOX CON FERMO PUNTA STRETTA

INOX

Articolo	Lmm	Tipo	€ Listino	
9161520	190	Sfuso	4,00	120
9161525	190	Blister	4,30	120



Per informazioni tecniche, foto e prezzi aggiornati visita il nostro sito www.cillisrl.com



**FORBICE INOX
CON FERMO CON CINTURINO**



Articolo	Lmm	Tipo	€ Listino	
9161530	190	Busta	3,60	120



**FORBICE INOX
UNIVERSALE COGLIFIORE**



Articolo	Lmm	Tipo	€ Listino	
9161550	190	Busta	5,90	120

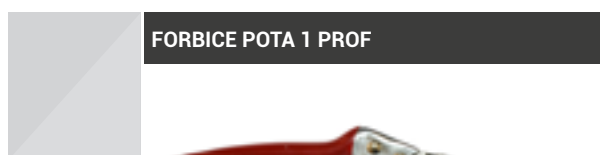

FORBICE POTA 1 PROF



Articolo	Tipo	€ Listino	
9180051	Doppio blister	7,40	72
9179070	Molla ricambio	0,50	100
9180055	Kit lama+bullone+molla	2,20	24



FORBICE POTA 3



Articolo	Tipo	€ Listino	
9180060	Busta	5,90	96
9180061	Doppio blister	6,00	72
9179080	Molla ricambio	0,50	100

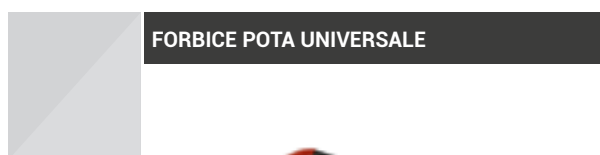

FORBICE POTA UNIVERSALE



Articolo	€ Listino	
9174810	6,50	12



FORBICE POTA 12 ANATOMICA



Articolo	€ Listino	
9180120	6,55	60



FORBICE POTA 5 INOX



Articolo	Lmm	€ Listino	
9170290	570x220x270	3,50	12



**FORBICE MANICO METALLO RIVESTIMENTO IN
PLASTICA FORGIATA CLASSICA**



Articolo	Lmm	€ Listino	
9174019	210	2,00	36

**FORBICE VIGNA PUTIGNANO
POTA PLASTIFICATA**



Articolo	Lmm	€ Listino	
9690119	190	6,70	36
9690121	210	7,00	36
9690123	230	9,00	12
9690125	250	7,00	12

**FORBICE POTA PUGLIA
PLASTIFICATA**



Articolo	Lmm	€ Listino	
9690018	180	5,50	60
9690023	230	6,00	60

FORBICE UNIVERSALE



Articolo	Lmm	€ Listino	
9175080	200	6,96	12

FORBICE VIGNA IN ALLUMINIO TOP



Articolo	Lmm	Tipo	€ Listino	
9174500	210	Laser	6,00	36



Per informazioni tecniche, foto e prezzi aggiornati visita il nostro sito www.cillisrl.com

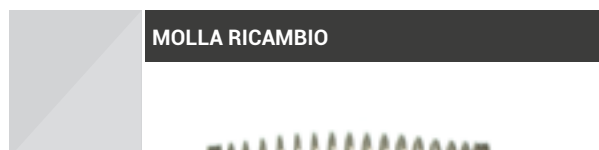

MOLLA RICAMBIO



Articolo	Ricambio per	Ø	Lmm	€ Listino	
9161655	9161380	6	56	0,50	50
	9161385				

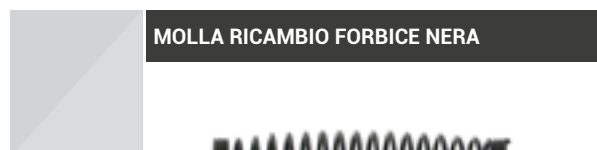

MOLLA RICAMBIO FORBICE NERA



Articolo	Ø	Lmm	€ Listino	
9161670	6	56	0,50	100

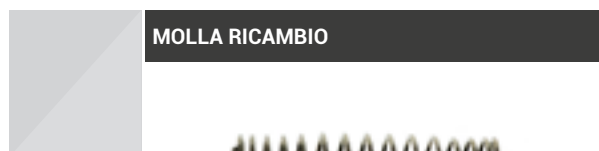

MOLLA RICAMBIO



Articolo	Ricambio per	Ø	Lmm	€ Listino	
9179060	9161380	6	50	0,50	50
	9161385				
	9161390				

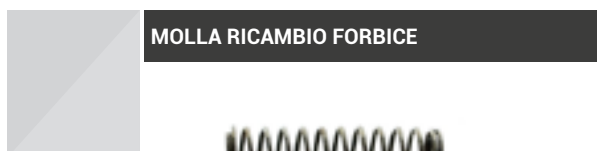

MOLLA RICAMBIO FORBICE



Articolo	Ø	Lmm	€ Listino	
9161650	6	32	0,12	100



MOLLA RICAMBIO



Articolo	Ricambio per	Ø	Lmm	€ Listino	
9179070	9180050	10	65	0,50	100
9179080	9180060	8	50	0,50	100
9179100	9170200	11	40	0,50	100



SET 200 PZ MOLLA RICAMBIO



Articolo	Ø	Lmm	€ Listino	
9161615	6	25	24,00	1



MOLLA POTA 1



Articolo	Ø	Lmm	€ Listino	
9180053	10	70	0,22	100



SET 200 PZ MOLLA RICAMBIO



Articolo	Ø	Lmm	€ Listino	
9179110	7	26	25,00	1

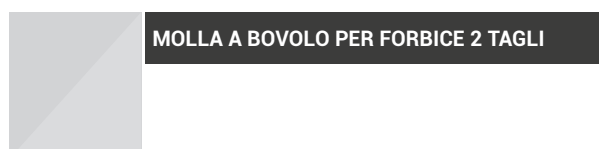

MOLLA A BOVOLO PER FORBICE 2 TAGLI



Articolo	Ricambio per	Ø	Lmm	€ Listino	
9700625	9161380	6	6X50	0,94	100



**FORBICE POTATURA BELLOTA
MANICO IN ALLUMINIO**



Articolo	Lmm	€ Listino	
9660330	210 mm	29,24	3



**FORBICE COGLIULIVA 170 MM
BELLOTA**



In omaggio un espositore in cartone ogni 24 pezzi acquistati.

Articolo	Lmm	€ Listino	
9660320	170 mm	8,72	24



**FORBICE COGLIULIVA 190 MM
BELLOTA**



In omaggio un espositore in cartone ogni 24 pezzi acquistati.

Articolo	Lmm	€ Listino	
9660315	190 mm	8,72	24



**FORBICE AGRUMI PUNTRA CORTA
BELLOTA**



In omaggio un espositore in cartone ogni 24 pezzi acquistati.

Articolo	Lmm	€ Listino	
9660300	160 mm	8,72	24



FORBICE COGLIULIVA PRO BELLOTA



In omaggio un espositore in cartone ogni 24 pezzi acquistati.

Articolo	Lmm	€ Listino	
9660305	210 mm	8,72	24



**FORBICE RACCOLTA FRUTTA BEL-
LOTA**



In omaggio un espositore in cartone ogni 24 pezzi acquistati.

Articolo	Lmm	€ Listino	
9660310	186 mm	8,72	24



**FORBICE RACCOLTA BELLOTA
PUNTA CURVA**



In omaggio un espositore in cartone ogni 24 pezzi acquistati.

Articolo	Lmm	€ Listino	
9660325	185 mm	8,72	24



**SET 12 MOLLE PER
FORBICI BELLOTA**



Articolo	€ Listino	
9660340	7,98	1





ZOOTECNICA





**INCUBATRICE DIGITALE BOROTTO
AUTOMATICA LUMIA 8+SIRIO**



PRO

Articolo	€ Listino	
8000090	326,40	1

L'incubatrice è idonea per uova di gallina, fagiano, faraona, quaglia, starna, pernice, anatra, germano, oca, tacchino, pavone, coturnice, piccione, colino, uccelli esotici e rapaci.

CARATTERISTICHE	
Modello incubatrice	Lumia 8
Capienza uova	0-8 oppure 32 piccole
Tensione nominale	12 V DC
Potenza massima	50 W
Consumo medio giornaliero	20 W
Display	Controllo digitale temperatura
Range	Temperatura modificabile da 30°C a 40°C
Termostato	Elettronico precisione +/- 0,1°C
Motore della Turbina	Asincrono Silenziato
Ventilazione	Assiale 12 VDC silenziato
Riscaldatore	Resistenza in cavo siliconato FLEX da 50 W
Misure - Peso	39x20x22 cm - 1,66 Kg



**INCUBATRICE DIGITALE BOROTTO
AUTOMATICA REAL 24+SIRIO**



PRO

Articolo	€ Listino	
8000080	340,00	1

L'incubatrice è idonea per uova di gallina, fagiano, faraona, quaglia, starna, pernice, anatra, germano, oca, tacchino, pavone, coturnice, piccione, colino, uccelli esotici e rapaci.

CARATTERISTICHE	
Modello incubatrice	Real 24 Automatica Prof.
Capienza uova	0-24 oppure 96 piccole
Tensione nominale	Monofase 230 Volt CE
Potenza massima	100 W
Consumo medio giornaliero	Max. 1 kW/24 ore
Display	Controllo digitale temperatura
Range	Temperatura modificabile da 30°C a 40°C
Termostato	Elettronico precisione +/- 0,1°C
Motore della Turbina	Asincrono Silenziato
Ventilazione	A turbina, diametro 100 mm
Riscaldatore	Resistenza in acciaio corazzato (AISI-304) di elevata qualità
Misure - Peso	50x38x26 cm - 3,85 Kg



INCUBATRICE DIGITALE BOROTTO AUTOMATICA REAL 49+SIRIO



PRO

Articolo	€ Listino	
8000070	408,00	1

L'incubatrice è idonea per uova di gallina, fagiano, faraona, quaglia, starna, pernice, anatra, germano, oca, tacchino, pavone, coturnice, piccione, colino, uccelli esotici e rapaci.

CARATTERISTICHE	
Modello incubatrice	Real 49 Automatica Prof.
Capienza uova	0-49 oppure 196 piccole
Tensione nominale	Monofase 230 Volt CE
Potenza massima	150 W
Consumo medio giornaliero	Max. 2 kW/24 ore
Display	Controllo digitale temperatura
Range	Temperatura modificabile da 30°C a 40°C
Termostato	Elettronico precisione +/- 0,1°C
Motore della Turbina	Asincrono Silenziato 2500rpm
Ventilazione	A turbina, diametro 100 mm
Riscaldatore	Resistenza in acciaio corazzato (AISI-304) di elevata qualità
Misure - Peso	58x57x25 cm - 5,5 Kg



INCUBATRICE DIGITALE BOROTTO AUTOMATICA REAL 49 + SIRIO CON BIOMASTER



PRO

Articolo	€ Listino	
8000060	462,40	1

L'incubatrice è idonea per uova di gallina, fagiano, faraona, quaglia, starna, pernice, anatra, germano, oca, tacchino, pavone, coturnice, piccione, colino, uccelli esotici e rapaci.

CARATTERISTICHE	
Modello incubatrice	Real 49 Automatica Prof.
Capienza uova	0-49 oppure 196 piccole
Tensione nominale	Monofase 230 Volt CE
Potenza massima	150 W
Consumo medio giornaliero	Max. 2 kW/24 ore
Display	Controllo digitale temperatura
Range	Temperatura modificabile da 30°C a 40°C
Termostato	Elettronico precisione +/- 0,1°C
Motore della Turbina	Asincrono Silenziato 2500rpm
Ventilazione	A turbina, diametro 100 mm
Riscaldatore	Resistenza in acciaio corazzato (AISI-304) di elevata qualità
Misure - Peso	58x57x25 cm - 5,5 Kg

**INCUBATRICE DIGITALE BOROTTO
AUTOMATICA LUMIA 8**

Articolo	€ Listino	
8000118	210,00	1

L'incubatrice è idonea per uova di gallina, fagiano, faraona, quaglia, starna, pernice, anatra, germano, oca, tacchino, pavone, coturnice, piccione, colino, uccelli esotici e rapaci.

**INCUBATRICE DIGITALE BOROTTO
SEMI AUTOMATICA REAL 24**

Articolo	€ Listino	
8000102	163,20	1

L'incubatrice è idonea per uova di gallina, fagiano, faraona, quaglia, starna, pernice, anatra, germano, oca, tacchino, pavone, coturnice, piccione, colino, uccelli esotici e rapaci.

**INCUBATRICE DIGITALE BOROTTO
AUTOMATICA REAL 24**

Articolo	€ Listino	
8000108	244,80	1

L'incubatrice è idonea per uova di gallina, fagiano, faraona, quaglia, starna, pernice, anatra, germano, oca, tacchino, pavone, coturnice, piccione, colino, uccelli esotici e rapaci.

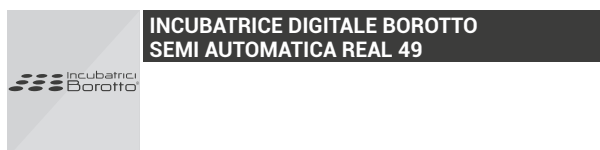
**INCUBATRICE DIGITALE BOROTTO
SEMI AUTOMATICA REAL 49**

Articolo	€ Listino	
8000104	244,80	1

L'incubatrice è idonea per uova di gallina, fagiano, faraona, quaglia, starna, pernice, anatra, germano, oca, tacchino, pavone, coturnice, piccione, colino, uccelli esotici e rapaci.

CARATTERISTICHE

Modello incubatrice	Lumia 8
Capienza uova	0-8 oppure 32 piccole
Tensione nominale	12 V DC
Potenza massima	50 W
Consumo medio giornaliero	20 W
Display	Controllo digitale temperatura
Range	Temperatura modificabile da 30°C a 40°C
Termostato	Elettronico precisione +/- 0,1°C
Motore della Turbina	Asincrono Silenziato
Ventilazione	Assiale 12 VDC silenziato
Riscaldatore	Resistenza in cavo siliconato FLEX da 50 W
Misure - Peso	39x20x22 cm - 1,66 Kg

CARATTERISTICHE

Modello incubatrice	Real 24
Capienza uova	0-24 oppure 96 piccole
Tensione nominale	Monofase 230 Volt CE
Potenza massima	100 W
Consumo medio giornaliero	Max. 1 kW/24 ore
Display	Controllo digitale temperatura
Range	Temperatura modificabile da 30°C a 40°C
Termostato	Elettronico precisione +/- 0,1°C
Motore della Turbina	Asincrono Silenziato
Ventilazione	A turbina, diametro 100 mm
Riscaldatore	Resistenza in acciaio corazzato (AISI-304) di elevata qualità
Misure - Peso	50x38x26 cm - 3,85 Kg

CARATTERISTICHE

Modello incubatrice	Real 24 Automatica Prof.
Capienza uova	0-24 oppure 96 piccole
Tensione nominale	Monofase 230 Volt CE
Potenza massima	100 W
Consumo medio giornaliero	Max. 1 kW/24 ore
Display	Controllo digitale temperatura
Range	Temperatura modificabile da 30°C a 40°C
Termostato	Elettronico precisione +/- 0,1°C
Motore della Turbina	Asincrono Silenziato
Ventilazione	A turbina, diametro 100 mm
Riscaldatore	Resistenza in acciaio corazzato (AISI-304) di elevata qualità
Misure - Peso	50x38x26 cm - 3,85 Kg



Per informazioni tecniche, foto e prezzi aggiornati visita il nostro sito www.cillisrl.com



INCUBATRICE DIGITALE BOROTTO AUTOMATICA REAL 49



Articolo	€ Listino	
8000110	326,40	1

L'incubatrice è idonea per uova di gallina, fagiano, faraona, quaglia, starna, pernice, anatra, germano, oca, tacchino, pavone, coturnice, piccione, colino, uccelli esotici e rapaci.

CARATTERISTICHE	
Modello incubatrice	Real 49 Automatica Prof.
Capienza uova	0-49 oppure 196 piccole
Tensione nominale	Monofase 230 Volt CE
Potenza massima	150 W
Consumo medio giornaliero	Max. 2 kW/24 ore
Display	Controllo digitale temperatura
Range	Temperatura modificabile da 30°C a 40°C
Termostato	Elettronico precisione +/- 0,1°C
Motore della Turbina	Asincrono Silenziato 2500rpm
Ventilazione	A turbina, diametro 100 mm
Riscaldatore	Resistenza in acciaio corazzato (AISI-304) di elevata qualità
Misure - Peso	58x57x25 cm - 5,5 Kg



INCUBATRICE REAL49 PLUS AUTOMATICA DIGITALE PROFESSIONALE



Articolo	€ Listino	
8000114	378,00	1

- Materiale ABS termoisolante.
- Additivo antibatterico biomaster.
- Artificial Intelligence control.

L'incubatrice è idonea per uova di gallina, fagiano, faraona, quaglia, starna, pernice, anatra, germano, oca, tacchino, pavone, coturnice, piccione, colino, uccelli esotici e rapaci.

CARATTERISTICHE	
Modello incubatrice	Real49 Plus automatica prof.
Capienza uova	0-49 oppure 196 piccole
Tensione nominale	Monofase 230 Volt CE
Potenza massima	150 W
Consumo medio giornaliero	70 W
Display	Controllo digitale temperatura
Range	Temperatura modificabile da 30°C a 40°C
Termostato	Elettronico precisione +/- 0,1°C
Motore girauova	Inclinazione completa una ogni ora
Ventilazione	A turbina, diametro 100 mm
Riscaldatore	Resistenza in acciaio corazzato AISI 304 di elevata qualità
Misure - Peso	59x58x26 cm - 6,8 Kg



SIRIO UMIDIFICATORE UNIVERSALE AUTOMATICO PER INCUBATRICI



Articolo	€ Listino	
8000170	158,00	1

INCUBATRICE NON IN DOTAZIONE

Questo dispositivo, progettato per le macchine BOROTTO, ma adattabile all'uso su incubatrici di qualunque marca, permette di raggiungere e mantenere l'adeguato livello di umidità durante l'incubazione e la schiusa a prescindere dalle variazioni dell'umidità ambientale, permettendo di ottimizzare la percentuale di schiusa delle uova incubate. SIRIO è costituito da una pompa peristaltica a doppio condotto, comandata da un microcomputer, che grazie a un algoritmo PID modificato, esegue in continuo il controllo d'erogazione dell'acqua. Un collegato sensore elettronico di ultima generazione (Sensirion di tecnologia svizzera), misura con estrema precisione l'umidità all'interno della macchina durante l'intero ciclo d'incubazione con assoluta stabilità, garantita per oltre 10 anni.

CARATTERISTICHE	
Peso	440 gr
Consumo medio giornaliero	1 W
Display	Per il controllo digitale dei parametri di umidità
Range	Umidità modificabile da un Min. del 40% a un Max. del 75%
Dimensioni	10,6 x 8,8 x 12,8 cm
Tensione di alimentazione	12 Vdc (alimentatore incluso)
Scheda elettronica	Microprocessore con algoritmo PID modificato

**GIRAUOVA BOROTTO AUTOMATICO
PER REAL 12/24/49 SEMIAUTO**



Articolo	€ Listino	
8000116	68,40	1

**MOTORE TURBINA PER
INCUBATRICE REAL**



Articolo		€ Listino	
8000300	12	56,00	1
8000303	24	56,00	1
8000306	49	56,00	1

TERMOSTATO PER INCUBATRICE REAL



Articolo	Real	€ Listino	
8000173	12	79,00	1
8000176	24	79,00	1
8000179	49	79,00	1

RESISTENZA PER INCUBATRICE REAL 12



Articolo	€ Listino	
8000182	26,10	1

RESISTENZA PER INCUBATRICE REAL 24



Articolo	€ Listino	
8000185	37,70	1

RESISTENZA PER INCUBATRICE REAL 49



Articolo	€ Listino	
8000188	43,50	1

PORTAUOVO FILA PER INCUBATRICE REAL



Articolo		€ Listino	
8000191	12	12,00	1
8000194	24	15,00	1
8000197	49	18,00	1

Per informazioni tecniche, foto e prezzi aggiornati visita il nostro sito www.cillisrl.com



Articolo	€ Listino	
8000120	56,40	3

eco-contributo raee € 0,21+IVA



Articolo	€ Listino	
8000128	56,00	1

eco-contributo raee € 0,42+IVA



Articolo	€ Listino	
8000130	85,54	3

eco-contributo raee € 0,42+IVA



Articolo	€ Listino	
8000132	134,16	2

eco-contributo raee € 0,42+IVA



Articolo	€ Listino	
8000200	165,10	2

eco-contributo raee € 0,42+IVA



Articolo	€ Listino	
8000250	202,98	2

eco-contributo raee € 0,42+IVA

• Girauova automatico applicabile, da acquistare a parte



Articolo	€ Listino	
8000160	235,00	1

eco-contributo raee € 0,42+IVA

• Girauova automatico applicabile, da acquistare a parte



Articolo	€ Listino	
8000165	285,56	1

eco-contributo raee € 0,42+IVA

• Girauova automatico applicabile, da acquistare a parte



**INCUBATRICE COVATUTTO 108
ANALOGIA MANUALE**



Articolo	€ Listino	
8000508	335,40	1

eco-contributo raee € 0,42+IVA

• Girauova automatico applicabile, da acquistare a parte



**INCUBATRICE COVATUTTO 108
DIGITALE MANUALE**



Articolo	€ Listino	
8000509	417,90	1

eco-contributo raee € 0,42+IVA

• Girauova automatico applicabile, da acquistare a parte



**INCUBATRICE COVATUTTO 162
ANALOGICA MANUALE**



Articolo	€ Listino	
8000500	459,40	1

eco-contributo raee € 0,42+IVA

• Girauova automatico applicabile, da acquistare a parte



**INCUBATRICE COVATUTTO 162
DIGITALE MANUALE**



Articolo	€ Listino	
8000502	492,92	1

eco-contributo raee € 0,42+IVA

• Girauova automatico applicabile, da acquistare a parte



**GIRAUOVA AUTOMATICO
PER COVATUTTO NOVITAL**



Articolo		€ Listino	
8000210	Covatutto 20/24 Eco24-54	67,56	3
8000220	Covatutto 40/120/108/162	67,56	3

eco-contributo raee € 0,21+IVA



TERMOMETRO INCUBATRICE COVA



Articolo		€ Listino	
8000790	Cova 7 + custodia	41,46	1
8000770	16-24E-24-54-40 120E4V	41,46	1
	162/108 24 ECO E 54		



**LAMPADINA OPACA E14
PER COVATUTTO NOVITAL**



Articolo	Cova	Watt	€ Listino	
8000133	7/12	40	5,00	1
8000135	16	60	5,00	1
8000137	16L	25	4,20	1



Per informazioni tecniche, foto e prezzi aggiornati visita il nostro sito www.cillisrl.com



RESISTENZA PER INCUBATRICE COVATUTTO



Articolo	Cova	Watt	€ Listino	
8000413	24eco-54	140	15,32	1
8000415	20	14	7,00	3
8000420	40/120	100	7,00	3



PORTA RESISTENZA PER INCUBATRICE COVATUTTO



Articolo	Cova	€ Listino	
8000416	24	6,80	1



SCHEDA ELETTRONICA COVA

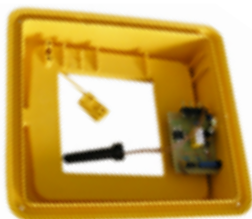

Articolo	Cova	€ Listino	
8000162	Cova 24E/24/54	84,60	1



SCHEDA ELETTRONICA PIU' SCATOLA - 120



Articolo	€ Listino	
8000405	238,00	1



TELAIO CASSETTO PER COVATUTTO 40-120



Articolo	€ Listino	
8000504	21,60	1



FONDO PER CASSETTO PORTA UOVA 40-120



Articolo	€ Listino	
8000506	17,50	1



LAMPADA SPERAUOVA



eco-contributo raee € 0,12+IVA

Articolo	€ Listino	
8000750	19,36	6

• Serve per seguire lo sviluppo degli embrioni contenuti nelle uova durante l'incubazione.

**LAMPADA INFRAROSSI
ROSSA 150W E27**



PRO

Articolo	Watt	€ Listino	
8021030	150	7,70	12
8021033	250	8,90	12

• Lampada ad infrarossi. Vetro temperato. Serve a riscaldare pulcini suini ed altri cuccioli di animali.

**RIFLETTORE RISCALDAMENTO
RAGGI INFRAROSSI E27**



PRO

Articolo	€ Listino	
8021010	28,90	6

• Riflettore a campana, porta lampada ad infrarossi. Completa di gancio per appendere. Con presa schuko. Circonferenza: 26,5 cm; Altezza: 33 cm; Lunghezza cavo: 1,70 mt Lampadina E27 non inclusa

RIFLETTORE RISCALDAMENTO E27 NEW



Articolo	€ Listino	
8021012	25,00	6

**RIFLETTORE REFLECT
CIP 100 A NORME E27**



eco-contributo raee € 0,08+IVA

Articolo	€ Listino	
8021000	21,24	6

• Circonferenza: 27 cm ; Altezza: 40 cm ; Lampadina E27 non inclusa

**RIFLETTORE ALADINO 250
A NORME E27**



eco-contributo raee € 0,08+IVA

Articolo	€ Listino	
8021003	29,00	4

• Circonferenza: 23cm; Altezza: 49 cm; Lampadina E27 non inclusa

**RIFLETTORE ALADINO 250 CON VARIATORE
A NORME E27**



eco-contributo raee € 0,08+IVA

Articolo	€ Listino	
8021005	36,48	4

• Circonferenza: 23 cm; Altezza: 49 cm; Lampadina E27 non inclusa

MOLINO A MANO PLASTICA



Articolo	Lcm		€ Listino	
8010204	19X19X31,5	2,788	126,90	1

SGRANATOIO PROF MANUALE



Articolo		€ Listino	
8012100	1,87	46,96	6

• Dotato di apposito sistema per il fissaggio ad un qualsiasi supporto; è realizzato per sgranare le pannocchie di mais separando automaticamente il tutolo.



MOLINO DAVIDE 4V

eco-contributo raee € 0,67+IVA

Articolo	Lcm	€ Listino	
8010050	67x90	255,68	2

CARATTERISTICHE

Motore a spazzole	580W
Hp	0,75
Alimentazione	230V
Produzione oraria	80-250Kg/h
Griglie in dotazione	2,5-4-6-8



MOLINO GOLIA 4V

eco-contributo raee € 0,67+IVA

Articolo	Lcm	€ Listino	
8010060	67x98	292,56	2

CARATTERISTICHE

Motore a spazzole	750W
Hp	1
Alimentazione	230V
Produzione oraria	130-260Kg/h
Griglie in dotazione	2,5-4-6-8





MOLINO MACINAPANE MAGNUM 4V

eco-contributo raee € 0,67+IVA

Articolo	Lcm	€ Listino	
8010100	67x98	341,40	1

CARATTERISTICHE

Motore a spazzole	750W
Hp	1
Alimentazione	230V
Produzione oraria	90-250Kg/h
Griglie in dotazione	2,5-4-6-8



MOLINO ERCOLINO 220V

eco-contributo raee € 0,67+IVA

Articolo	Lcm	€ Listino	
8010300	62x102	663,78	1

CARATTERISTICHE

Motore	1500W
Hp	2
Alimentazione	220V
Produzione oraria	60-360Kg/h
Griglie in dotazione	2,5-4-6-8





MOLINO + SGRANATOIO NUOVO UNI BLOC

eco-contributo raee € 0,67+IVA

Articolo	Lcm	€ Listino	
8010150	59x111	800,00	1

CARATTERISTICHE

Motore	1500W
Hp	2
Alimentazione	220V
Produzione oraria	10-230Kg/h
Griglie in dotazione	2,5-4-6-8



SGRANATOIO NUOVO RAMBO

eco-contributo raee € 0,67+IVA

Articolo	Lcm	€ Listino	
8012110	72x118	387,00	1

CARATTERISTICHE

Motore	180W
Hp	0,25
Alimentazione	220V
Produzione oraria	120-160Kg/h



**CRIVELLO RICAMBI
MOLINO DAVIDE, GOLIA, BRAVO E MAGNUM**



Articolo	Ø	€ Listino	
8031121	1 mm	13,50	1
8031122	1,5 mm	13,50	1
8031124	4 mm	13,50	1
8031125	6 mm	13,50	1

**BLOCCO LAME D RICAMBI
MOLINO NUOVO DAVIDE 4V**



Articolo	€ Listino	
8032030	19,80	1

• Ricambio per molino Davide e vecchi Davide- Unip-N.Unip-Boss-N. Boss

**BLOCCO LAME G
RICAMBI MOLINO GOLIA**



Articolo	€ Listino	
8032050	20,52	1

**LAMA PER MAGNUM
SAGOMATA G**



Articolo	Lcm	€ Listino	
8032038	30x5x120,5	5,12	1

**BLOCCO LAME D
RICAMBI MOLINO MAGNUM 4V**

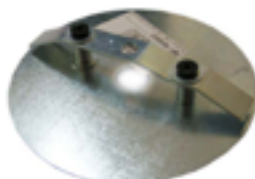

Articolo	€ Listino	
8032033	18,80	1

MOTORE MOLINI NOVITAL



Articolo	Hp	Molini	€ Listino	
8030043	0,75	Davide s.s+pt Novital	150,00	1
8030045	1	Golia 4V e Magnum	178,00	1

MOTORE MOLINO NOVITAL



Articolo	Hp	Molini	€ Listino	
8010305	2	Ercolino 220V	328,00	1

CONVOGLIATORE FISSO BLU PER MOLINI 4V



Articolo	€ Listino	
8010055	9,00	1



Per informazioni tecniche, foto e prezzi aggiornati visita il nostro sito www.cillisrl.com

ELETTROMULINO 1,6 HP 50LT BLU



Articolo	Lcm	€ Listino	
8010040	43x43x65	230,00	2

CARATTERISTICHE

Tipo motore	Monofase
Hp	1,6
Contenitore	50Lt
Alimentazione	220v - 50 Hz
Produzione oraria	30-210 Kg/h
Crivelli in dotazione	1,5-3-5-7 mm

ELETTROMULINO 2 HP 50LT ARANCIO



Articolo	Lcm	€ Listino	
8010045	43x43x70	249,50	2

CARATTERISTICHE

Tipo motore	Monofase
Hp	2
Contenitore	50Lt
Alimentazione	220v - 50 Hz
Produzione oraria	30-250 Kg/h
Crivelli in dotazione	1,5-3-5-7 mm

ELETTROMULINO 1,6 HP 50LT ALLUMINIO



Articolo	Lcm	€ Listino	
8010048	43x43x65	272,60	2

CARATTERISTICHE

Tipo motore	Monofase
Hp	1,6
Contenitore	50Lt
Alimentazione	220v - 50 Hz
Produzione oraria	30-250 Kg/h
Crivelli in dotazione	1-1,6-3mm

CRIVELLO GRIGLIA PER MULINI



Articolo	Ø	€ Listino	
8010071	1,5mm	15,85	1
8010072	3mm	15,85	1
8010073	5mm	15,85	1

• Ricambio per 8010040, 8010045, 8010048

MOTORE RICAMBIO MULINO



Articolo	Hp	€ Listino	
8010041	1,6	72,50	1
8010046	2	87,00	1

LAMA RICAMBIO MOLINO PER EMC50 BIANCO E EMC60 ARANCIO



Articolo	€ Listino	
8010042	4,80	1

RICAMBIO BIDONE PER ELETTROMULINO



Articolo	€ Listino	
8010043	49,50	1

• Ricambio per 8010040, 8010045, 8010048

NIDO SINGOLO PER OVAIOLE



Articolo	€ Listino	
8013020	43,26	4

GABBIA PER PULCINI SMONTABILE



Articolo	Lcm	Kg	€ Listino	
8025005	100x63x65	10,00	68,60	3

GABBIA PER GALLINE OVAIOLE RURALE SMONTABILE



Articolo	Lcm	Kg	€ Listino	
8025010	97x75x78	10,00	122,24	2

CONIGLIERA CON DUE NIDI SMONTABILE



Articolo	Lcm	Kg	€ Listino	
8025050	149x66x66	13,70	142,80	2

CONIGLIERA TOSCANA CON DUE NIDI SMONTABILE



Articolo	Lcm	Kg	€ Listino	
8025055	150x64x75	19,70	220,50	2

POLLAIO DA ESTERNO PER GALLINE OVAIOLE



Articolo	Lcm	Kg	€ Listino	
8025070	145x112x144	36,00	348,50	1

CUCITURA PER POSATOI 72 CM



Articolo	Lcm	€ Listino	
8018560	Cucitura per posatoi 72cm	0,60	20



Per informazioni tecniche, foto e prezzi aggiornati visita il nostro sito www.cillisrl.com

PINZA PER GANCIO



PRO

Articolo	Ø	€ Listino	
8020040	4	12,00	12
8020045	6	14,00	12

GANCIO RETE GABBIE



PRO

Articolo	Ø	€ Listino	
8020050	4	15,60	10Kg
8020055	6	15,60	10Kg



MANGIATOIA A BARRETTA PER PULCINI



Articolo	Lcm	€ Listino	
8014050	50	3,98	24



MANGIATOIA A BARRETTA PER POLLI



Articolo	Lcm	€ Listino	
8014150	50	6,06	24



MANGIATOIA TRAMOGGIA 2 SCOMPARTI PLASTICA



Articolo	€ Listino	
8013110	7,24	24
8013120	Coperchio mangiatoia 1,30	24



MANGIATOIA A TRAMOGGIA



Articolo	Tipo	€ Listino	
8014005	5-10Kg 15Lt	10,50	10
8014020	Coperchio mangiatoia	1,61	10



MANGIATOIA A TRAMOGGIA CON COPERCHIO

Articolo	Lt	€ Listino	
8014023	2,25	6,94	20
8014022	5,25	10,42	12
8014021	10,5	12,16	10
8014025	20	15,00	10



MANGIATOIA KUBIC PREMIUM



Articolo	Lt	€ Listino	CFM
8014045	50	59,80	3

• Mangiatoia Kubic Premium lt 50 / kg 34
 Mangiatoia realizzata in plastica ad uso alimentare, facile da montare senza l'ausilio di viti e/o utensili. Grazie ad una cerniera posta sul serbatoio, il coperchio può essere sollevato o completamente rimosso per facilitare le operazioni di manutenzione e pulizia, che si possono così effettuare anche in profondità.
 Dotata di rastrelliera antispreco per un corretto dosaggio del foraggio. Le gambe robuste garantiscono stabilità e mantengono la mangiatoia sollevata da terra per preservarla da eventuali contaminazioni esterne. Resistente agli urti e alle alte e basse temperature. Grazie al nuovo design salva spazio, la mangiatoia Kubic Premium è impilabile.

ABBEVERATOIO RODITORI PRESA ACQUA 45°



Articolo	LT	€ Listino	CFM
8017143	100 cl	6,78	24

SET 2 ABBEVERATOI PORTABOTTIGLIE SMONTATO



Articolo	€ Listino	CFM
8017075	3,22	100

PER BOTTIGLIE 1,5-2 LT - 23 CM



Articolo	€ Listino	CFM
8016210	2,48	48



ABBEVERATOIO A SIFONE



Articolo	Lt	€ Listino	CFM
8016050	5	4,44	24
8016080	10	7,30	12

ABBEVERATOIO AUTOMATICO POLLI CON PIEDI EVOLUTION



Articolo	Lt	€ Listino	CFM
8017520	6	34,00	5

SERBATOIO CON COPERCHIO E FORO



Articolo	Lt	€ Listino	CFM
8018915	18	12,38	12

ABBEVERATOIO AUTOMATICO



Articolo	Lt	€ Listino	CFM
8017510	18	17,40	6
8017504	Coperchio	4,46	1

Per informazioni tecniche, foto e prezzi aggiornati visita il nostro sito www.cillisrl.com



Articolo	Lt	€ Listino	
8017515	24	23,80	4



Articolo	Lt	€ Listino	
8017500	30	41,80	4

• Il nuovo abbeveratoio lt 30 è completamente realizzato in materiale plastico assolutamente igienico, facile da pulire, stabile e resistente. Abbeveratoio a livello costante, con serbatoio realizzato in un unico pezzo. Dimensioni: h72x Ø 43

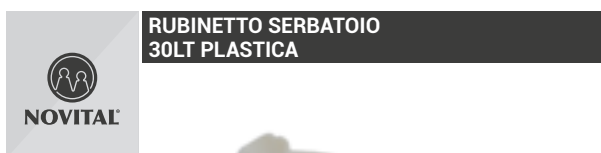

Articolo	€ Listino	
8017506	0,70	4

• Ricambio per 8017500



Articolo	€ Listino	
8017503	3,98	1

• Ricambio per 8017500



Articolo	€ Listino	
8017512	5,67	24

• Ricambio per 8017510 - 8017515

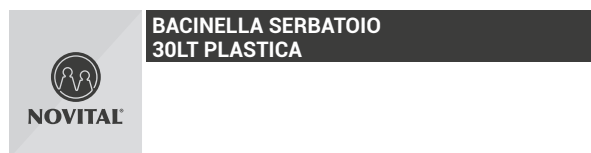

Articolo	€ Listino	
8017507	4,10	1

• Ricambio per 8017500



Articolo	Lt	€ Listino	
8017523	30	54,00	3
8017525	50	67,18	3



Articolo	Lt	€ Listino	
8018980	8	17,95	6



ABBEVERATOIO COLOMBI



Articolo	€ Listino	
8016221	8,56	15



ABBEVERATOIO A VASCHETTA



Articolo	Lcm	€ Listino	
8016150	6	4,90	24
8016160	12	5,28	24



ABBEVERATOIO PLASTICA AUTOMATICO



Articolo	Lt	€ Listino	
8020955	4	23,00	4
8020957	6	27,40	4

• Abbeveratoio automatico da muro con galleggiante. Costituito da struttura in PL per un maggiore igiene.



ABBEVERATOIO NYLON AUTOMATICO PREMIUM PER TORI MUCCHE E CAVALLI



Articolo	Lt	€ Listino	
8020960	4	34,42	4
8020962	6	42,70	4

• Abbeveratoio automatico da muro con galleggiante. Costituito da struttura in Nylon per un maggiore resistenza. Adatto anche a mucche, tori e cavalli. Costituito da struttura in PL per un maggiore igiene.



GALLEGGIANTE PER ABBEVERATOIO PLASTICA AUTOMATICO



Articolo	€ Listino	
8020965	8,50	5

• Adatto ai modelli 8020955-8020957-8020960-8020962

ABBEVERATOIO PER CANI AUTOMATICO 2 LT



Articolo	Lcm	€ Listino	
8020950	21x27x11	22,00	12

ABBEVERATOIO CON LINGUA INOX NERO



Articolo	€ Listino	
8021215	23,18	6

• Ciotola in ghisa, paletta per naso in acciaio inox.
 • Attacco acqua superiore e inferiore 1/2"
 • Capacità della ciotola 1,45 litri

Per informazioni tecniche, foto e prezzi aggiornati visita il nostro sito www.cillisrl.com

ROTOLO TUBO NERO FLESSIBILE



PRO

Articolo	Lmt	Ø	€ Listino	
8017810	100	9x12 mm	58,00	5

FILTRO IN LINEA

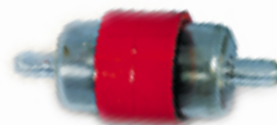

Articolo	€ Listino	
8017870	10 mm 2,26	24

TAPPO



Articolo	Ø	€ Listino	
8018510	10 mm	0,20	100

RACCORDO A T DI COLLEGAMENTO



PRO

Articolo	Ø	€ Listino	
8017850	10 mm	0,24	500

MOLLA FISSAGGIO TUBO QUADRO



Articolo	€ Listino	
8020035	0,10	100

MOLLA RICAMBIO



PRO

Articolo	€ Listino	
8020010	0,44	12

ABBEVERATOIO ATTACCO A MOLLA CON TEE



PRO

Articolo	Attacco	€ Listino	
8017550	10 mm	1,98	100

ABBEVERATOIO ATTACCO A VITE CON TEE



PRO

Articolo	Attacco	€ Listino	
8017580	10 mm	2,32	100

USCITA PORTAGOMMA PLASTICA



PRO

Articolo	Ø	€ Listino	
8019020	10 mm	0,74	10

• Con dado

ABBEVERATOIO A GOCCIA



PRO

Articolo	Passo	€ Listino	
8017560	1/8	1,58	100

ABBEVERATOIO SUINETTI INOX



PRO

Articolo	Passo	Ø	€ Listino	
8020805	1/2	17 mm	7,80	20

ABBEVERATOIO SUINO INOX



PRO

Articolo	Passo	Ø	€ Listino	
8020810	1/2	21 mm	8,80	20

ABBEVERATOIO SCROFE INOX



PRO

Articolo	Passo	Ø	€ Listino	
8020850	1/2	27 mm	11,50	20

ATTACCO INCLINATO 45° PER ABBEVERATOIO SUINO INOX



Articolo	Passo	Ø	€ Listino	
8020910	1/2x1/2	19	4,96	20

• Fori: 9mm • Interasse: 54mm

SPELA SUINI PER TRAPANO INOX

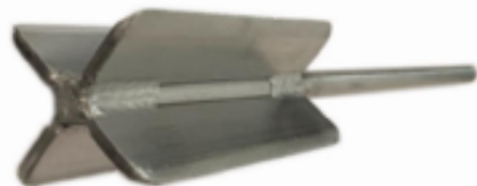

Dimensioni:
Lunghezza totale: 30cm,
Lunghezza lame: 10,5 cm,
Spessore leme: 3mm
Diamentro per attacco trapano: 10mm

INOX **PRO**

Articolo	Lcm	Ø	€ Listino	
8026000	30	10 mm	75,00	5



Per informazioni tecniche, foto e prezzi aggiornati visita il nostro sito www.cillisrl.com

ATTACCO INCLINATO 25° PER ABBEVERATOIO SUINO OTTONE



Articolo	Passo	Ø	€ Listino	
8020915	1/2	19 mm	11,20	20

TETTARELLA RICAMBIO CAUCCIÙ



Articolo	€ Listino	
8021155	2,36	30

TETTARELLA PER BIBERON



Articolo	€ Listino	
8021275	0,98	100

TETTARELLA RICAMBIO PER SECCHIO AGNELLI



Articolo	€ Listino	
8021280	0,86	120

SECCHIO PER ALLEVAMENTO VITELLI



Articolo	€ Listino	
8021150	17,10	8

SECCHIO ABBEVERATOIO VITELLI



Articolo	Lt	€ Listino	
8020900	10	21,02	10

• Completo di Super-Teat e valvola a vite, manico in metallo resistente agli acidi a prova di cibo facile da pulire.

SPENNAPOLLI ESTERINA



NOVITAL

CARATTERISTICHE

Alimentazione	0,5 Hp - 220V
Produzione oraria	80 polli circa
Dimensioni imballo	45,5x61,5x31 cm
Peso	24,50 Kg

Articolo	€ Listino		
8001710	410,00	1	
8001718	Dita ricambio	1,36	20

eco-contributo raee € 0,67+IVA



**SPIUMATRICE A 1 RULLO
IN ACCIAIO INOX**

Articolo	€ Listino	
8025100	416,00	1

CARATTERISTICHE

Alimentazione	50Hz - 220/230V
Produzione oraria	30-40 polli circa
Dimensioni imballo	52x42x77 cm
Peso	19,00 Kg



SPIUMATRICE POLLI 24 DITA - NOVITAL

Realizzata in abs 24 dita in gomma 6 coppie di dischi griglia di sicurezza regolabile in funzione dell'animale da spiumare dotata di gancio per poter sostenere il sacco raccogli piume (non in dotazione) piedini antivibranti motore monofase asincrono 230 V-50 Hz -300W 6 poli 900 giri/min pulsante di sicurezza produzione oraria indicativa (polli + quaglie con griglia, 60/80 polli 4 versioni polli+quaglie senza griglia)

Articolo	€ Listino	
8001712	571,20	1



**RULLI DI
SPIUMATURA RU 06**

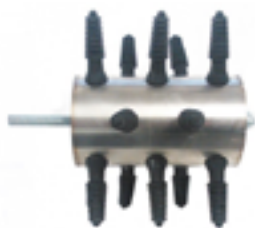

Articolo	€ Listino	
8025120	72,57	2

**RULLI DI
SPIUMATURA RU 08**



Articolo	€ Listino	
8025125	87,59	2

**CARTER + RULLI
DI SPIUMATURA RU8**



CARATTERISTICHE

Alimentazione	Con trapano non compreso
Produzione oraria	50-80 polli circa
Dimensioni imballo	26x25 cm
Peso	1,10 Kg

Articolo	€ Listino	
8025130	187,68	1

**SPIUMATRICE A RULLO PER
TRAPANO SENZA TRAPANO**



CARATTERISTICHE

Alimentazione	Con trapano non compreso
Produzione oraria	50-80 polli circa
Dimensioni imballo	55x50x150 cm
Peso	10,00 Kg

• Completo di sistema di bloccaggio del trapano e sistema di fissaggio all'asta di supporto. Trapano non compreso.

Articolo	€ Listino	
8025135	287,78	1

Per informazioni tecniche, foto e prezzi aggiornati visita il nostro sito www.cillisrl.com

TERMOMETRO DIGITALE CON SONDA



Articolo	€ Listino	
8025145	20,40	6

CONO SINGOLO MEDIO PER DISSANGUAMENTO POLLI



Articolo	Lcm	€ Listino	
8025150	22x28x8	40,00	4

PINZA PER MACELLAZIONE POLLI



Articolo	Lcm	€ Listino	
8025155	19x5	49,00	3



ELETTIFICATORE PER RECINTI

Apparecchio con alimentatore da 230 V, per recinti con poca vegetazione, adatto a paddock e piccoli pascoli. Con spia di funzionamento. Scatola in plastica robusta e resistente agli agenti atmosferici.



Articolo	€ Listino	
8013200	168,30	1

CARATTERISTICHE

Alimentazione	230V
Corrente di carica	1,6J
Max scarica corrente	1,1J
Voltaggio max.	10.900V
Voltaggio a 500 Ohms	3.400V
Consumo corrente	5W
Lunghezza max forte vegetazione	1 Km
Lunghezza max poca vegetazione	10 Km
Lunghezza max senza vegetazione	35 Km

RECINTO ELETTRICO DUO NA 2300

- Microprocessore 2 livelli di tensione (Alta/Bassa)
- Voltaggio massimo: 12000 V
- Lunghezza massima recinto senza crescita vegetativa: 20 km

Articolo	€ Listino	
8021310	240,00	1



KIT RECINZIONE ELETTRIFICATA PER CINGHIALI CON PALETTI ISOLANTI 250 MT



Kit completo di tutto l'occorrente per la realizzazione di una recinzione elettrificata adatta a dissuadere cinghiali, volpi, lupi, cervi e simili.



COMPOSIZIONE DEL KIT

Quantità	Componente
1 pz	Elettrificatore a batteria Burg B9
1 pz	Batteria per elettrificatore 9V - 90 Ah
2 pz	Rotolo 250 mt di filo in acciaio 3 conduttori x Ø 0,16 mm - colore arancio
25 pz	Paletto isolante in plastica altezza 105 cm adatto per 5 corde / 3 bande
1 pz	Cavetto per massa a terra con morsetto a cocodrillo
1 pz	Cavetto di allacciamento recinzione con morsetto a cocodrillo
4 pz	Targhetta di segnalazione
1 pz	Paletto zincato per massa a terra
1 pz	Set cancello con molla



Articolo	€ Listino	
8013300	324,00	1

KIT RECINZIONE ELETTRIFICATA PER CINGHIALI CON ISOLATORI A VITE 250 MT



Kit completo di tutto l'occorrente per la realizzazione di una recinzione elettrificata adatta a dissuadere cinghiali, volpi, lupi, cervi e simili.



COMPOSIZIONE DEL KIT

Quantità	Componente
1 pz	Elettrificatore a batteria Burg B9
1 pz	Batteria per elettrificatore 9V - 90 Ah
2 pz	Rotolo 250 mt di filo in acciaio 3 conduttori x Ø 0,16 mm - colore arancio
50 pz	Isolatore ad anello nero con vite corta per legno
1 pz	Cavetto per massa a terra con morsetto a cocodrillo
1 pz	Cavetto di allacciamento recinzione con morsetto a cocodrillo
4 pz	Targhetta di segnalazione
1 pz	Paletto zincato per massa a terra
1 pz	Set cancello con molla



Articolo	€ Listino	
8013305	261,00	1

Per informazioni tecniche, foto e prezzi aggiornati visita il nostro sito www.cillisrl.com



ELETTRIFICATORE B9 PER RECINTI A BATTERIA

Apparecchio a batteria da 9 o 12 Volt (batteria non inclusa) per l'impiego mobile su piccolo pascolo con poca o senza vegetazione. Ideale per cavalli, bestiame o piccoli animali come cani, gatti e pollame. Contenitore in plastica antiurto e resistente agli agenti atmosferici. Ideale per piccoli recinti. Fornito con barra di messa a terra e cavo di collegamento recinto-terra.



0,25
INPUT JOULE
9 VOLT

0,32
INPUT JOULE
12 VOLT

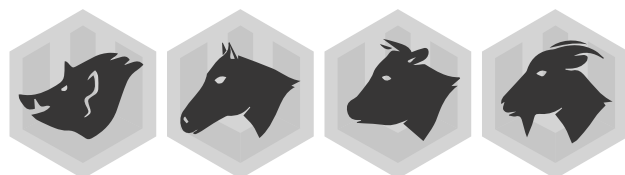

Articolo	€ Listino	
8013203	163,20	1

CARATTERISTICHE	
Alimentazione	9V
Corrente di carica	0,25J
Max scarica corrente	0,17J
Voltaggio max.	9.400V
Voltaggio a 500 Ohms	2.600V
Consumo corrente	26 mA
Lunghezza max forte vegetazione	0,3 Km
Lunghezza max poca vegetazione	3 Km
Lunghezza max senza vegetazione	7 Km

La batteria non è inclusa, va ordinata a parte, codice batterie: 8013206



BATTERIA 9 VOLT 90Ah PER RECINTI

Batteria a secco 9 V zinco-carbonio
 Batteria a secco standard per l'utilizzo su recinzioni elettrificate non predisposte al funzionamento con potenza massima.
 Prodotto alta qualità privo di piombo, mercurio e cadmio



Articolo	Durata	€ Listino	
8013206	10.000 ore	31,62	5



BANDE RECINZIONI ELETTRICHE 200 MT

Articolo	€ Listino	
8013215	19,72	5

CARATTERISTICHE

Ampere	90
Durata	10.000 ore
Larghezza	20 mm
Colore	giallo-arancio
Conduttori	4 x Ø 0,16mm



FILO IN ACCIAIO PER RECINZIONE ELETTRICHE



Articolo	€ Listino	
8013265	10,84	8

CARATTERISTICHE 8013265

Larghezza	250 mt
Colore	arancio
Conduttori	3 x Ø 0,16mm

FILO IN ACCIAIO PER RECINZIONE ELETTRICHE



Articolo	€ Listino	
8013270	29,40	4

CARATTERISTICHE 8013270

Larghezza	200 mt
Colore	bianco
Conduttori	6 x Ø 0,20mm

ELETRIFICATORE A PANNELLO SOLARE



Articolo	€ Listino	
9740050	319,62	1

• Elettrificatore ranch a pannello solare 3W completo di batteria ricaricabile 12V 24 ah lunghezza massima del recinto 2 Km, energia di carica 0,24 joule

ELETRIFICATORE A PANNELLO SOLARE



Articolo	€ Listino	
9740055	497,76	1

• Elettrificatore ranch a pannello solare 12W completo di batteria ricaricabile 12V 24 ah lunghezza massima del recinto 8 Km, energia di carica 0,48 joule

RETE PER OVINI

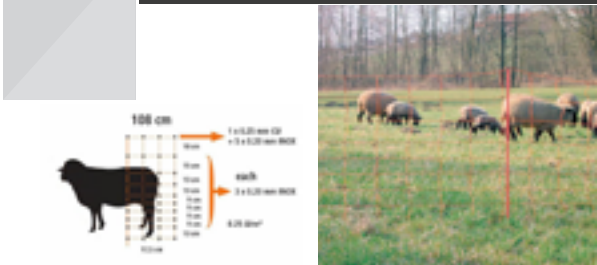

Articolo	€ Listino	
8013212	152,34	1

CARATTERISTICHE

Altezza	108 cm
Picchetti	9
Cavetti	9
Filo acciaio	3x0,20 mm
Lunghezza	50 mt

ROTOLO 200 MT CAVETTO ACCIAIO PER RECINTI ELETTRIFICATI



Articolo	Ø	€ Listino	
8013214	1,2 mm	16,64	4

- Ideale per difendersi dai cinghiali ed animali selvatici.
- 7 fili intrecciati, molto flessibile e facile da installare.

SET CANCELLO RECINTI CON MOLLA



Articolo	€ Listino	
8013218	9,72	4

- Si allunga fino a 5mt. Composto da: 1 maniglia con gancio, 1 molla speciale, 2 isolatori (non adatti per cavalli).

ISOLATORE AD ANELLO CON SUPPORTO CORTO



Articolo	Ø	€ Listino	
8013221	6 mm	0,30	50

ISOLATORE AD ANELLO CON SUPPORTO LUNGO



Articolo	Ø	€ Listino	
8013224	6 mm	0,30	50

PALETTO ISOLANTE IN PLASTICA



Articolo	Lcm	€ Listino	
8013227	104	2,92	5
8013230	156	4,04	5

- Occhielli 8013227 : 5 per corde e 3 per bande
 - Occhielli 8013230 : 4 per corde e 7 per bande
- Punta zincata: 21 cm

CONNETTORE ZINCATO PER BANDE



Articolo	Lmm	€ Listino	
8013245	20	0,90	50

Per informazioni tecniche, foto e prezzi aggiornati visita il nostro sito www.cillisrl.com

CONNETTORE BANDA A CAVETTO



Articolo	Lmm	Ø	€ Listino	
8013248	40	2,5mm	1,46	50

CAVETTO ALLACCIAMENTO PER RECINZIONE



Articolo	€ Listino	
8013254	6,12	1

• Morsetto a coccodrillo robusto, cavo staccato lungo 1mt, M8.

CAVETTO PER MASSA A TERRA



Articolo	€ Listino	
8013257	7,90	1

• Morsetto a coccodrillo robusto, cavo staccato lungo 1mt, M8.

CONNETTORE PER BANDA



Articolo	€ Listino	
8013260	7,42	10

• Morsetto in plastica per banda fino a 40mm. Lunghezza cavo 80cm

CONNETTORE BANDA A CAVETTO



Articolo	Lmm	€ Listino	
8013239	40	9,04	10

• Connessione meccanica ed elettrica ideale tra apparecchio e banda. Lunghezza cavo 80 mm.

CONNETTORE DOPPIO BANDA CAVETTO



Articolo	Spessore	€ Listino	
8013242	40	12,78	10

• Connessione meccanica ed elettrica ideale tra apparecchio e banda. Lunghezza cavo 80 mm.

PALETTO ZINCATO PER MASSA A TERRA



Articolo	Lmt	€ Listino	
8013251	1	16,10	5

TARGHETTA DI SEGNALAZIONE



Articolo	€ Listino	
8013233	2,50	50

BANDA MULTI CLASSE BIANCA



Articolo	€ Listino	
8021330	47,72	3

- Spessore 40 mm
- Lunghezza 200 mt

CAVO D'ATTACCO 12 VOLT PER RECINTI



Articolo	€ Listino	
8021325	23,12	6

SET 10 ISOLATORI VARIO PLUS PER BANDA FINO A 40 MM DI LARGHEZZA



BREVETTATO

Articolo	€ Listino	
8021340	4,08	32

- Per montanti in metallo o plastica fino a \varnothing 17 mm
- Plastica resistente agli urti molto robusta

SET 10 ISOLATORI PER FILI VARIO PLUS



BREVETTATO

Articolo	€ Listino	
8021345	3,80	40

- Per montanti in metallo o plastica fino a \varnothing 17 mm
- Plastica resistente agli urti molto robusta

TIRANTE PER FILO ROTANTE



Articolo	€ Listino	
8021350	4,06	36

- Stringe o allenta rapidamente fili, funi, fili di poliesteri senza tagliarli in due

MANIGLIA NERA PER RECINTO ELETTRIFICATO CON GANCIO E IMITATORE DI TENSIONE



Articolo	€ Listino	
8021355	2,48	60

RETE DI PROTEZIONE PER ANIMALI



Articolo	€ Listino	
8021360	111,10	1

- Lunghezza 50 m • • 3 file TriCOND, bianco / blu con tre fili TriCOND da 3 x 0.30 mm fino a 10.000 m di lunghezza

SET 25 ISOLATORI A CLIP MAXI TAPE 6 MM



Articolo	€ Listino	
8021335	8,00	20



PUNGOLO ELETTRICO TORERO CLASSIC



Articolo	€ Listino	
8021195	33,30	4

- Dimensioni: 13 x 8 x 3 cm
- Inclusa Batteria piatta da 4,5 volt

FORBICE PER TOSARE



Articolo	Lcm	€ Listino	
9173500	30,5	10,20	12

FORBICE MANUALE PECORE



Articolo	€ Listino	
8021305	34,76	4

- Denti ampiamente distanziati circa 25 cm di lunghezza
- Larghezza di taglio 45 mm

TOSATRICE A BATTERIA DELOX PER RIFINITURE



Articolo	€ Listino	
8021395	65,86	3

- Regolazione dell'altezza di taglio a 5 stadi tramite pulsante

TOSATRICE BOVINI E CAVALLI 200W



PRO

Articolo	€ Listino	
8021100	244,96	1

- Anche per animali molto sporchi o con pellicce arruffate. • 31/15 denti - Peso escluso cavo: 1190gr.

TOSATRICE BOVINI 230V / 400W



PRO

Articolo	€ Listino	
8021105	541,36	1

- Anche per animali molto sporchi o con pellicce arruffate. • Doppie corse / min: 2400 • Lunghezza del cavo: 3 m.

TOSATRICE CAVALLI 230V / 120W 31/15 DENTI



PRO

Articolo	€ Listino	
8021110	541,36	1

• Doppie corse / min: 2300 • Lunghezza del cavo: 3 m.

TOSATRICE PECORE 350W PROF. 6 VELOCITÀ 13/4 DENTI



PRO

Articolo	€ Listino	
8021115	244,96	1

• Doppie corse / min: 2400 • Lunghezza del cavo: 5,5 m.

TOSATRICE PECORE 230V / 400W 13/4 DENTI



PRO

Articolo	€ Listino	
8021120	569,86	1

• Anche per animali molto sporchi o con pellicce arruffate.
• Doppie corse / min: 2400 • Lunghezza del cavo: 3 m.

SET LAME 3 + 4 - 17/18 DENTI



PRO

Articolo	€ Listino	
8021125	70,50	3

• Adatto per attrezzature constanta3, constanta4, FarmClipper e cesoie di Aesculap, Heiniger e Lister-Liscop.

SET LAME 3 + 4 - 31/15 DENTI BOVINI E CAVALLI STANDARD



PRO

Articolo	€ Listino	
8021320	60,00	3

• Adatto per attrezzature constanta3, constanta4, FarmClipper e cesoie di Aesculap, Heiniger e Lister-Liscop.

LAME SUPERIORE INFERIORE WELLINGTON



PRO

Articolo	€ Listino	
8021130	40,46	3

TOSATRICE OSTER POWER PRO ULTRA POWER MAX



PRO

LAME NON INCLUDE!

Articolo	€ Listino	
8021135	252,23	1

• Facile manovrabilità con design ergonomico. • 2 velocità
• Compatibile con tutte le lame 8021140 e 8021145. • Cavo da 3,6m.

TESTINA N° 5 LUNGHEZZA 6,3 MM SKIP TOOTH



PRO

Articolo	€ Listino	
8021140	70,92	3

Per informazioni tecniche, foto e prezzi aggiornati visita il nostro sito www.cillisrl.com

TESTINA N° 40 LUNGHEZZA 0,25 MM



Articolo	€ Listino	
8021145	52,59	3

TOSATRICE A BATTERIA TAPROX PER FINITURE



Articolo	€ Listino	
8021365	45,18	3

• La testa di taglio in acciaio inossidabile con una larghezza di taglio di 40 mm. Batterie agli ioni di litio 2000 mAh. Tempo di funzionamento 200 min

TOSATRICE A BATTERIA DROPIX PER RIFINITURE



Articolo	€ Listino	
8021375	38,76	4

• Regolazione dell'altezza di taglio a 4 stadi tramite pulsante. Inclusi accessori estesi con 4 pettini a scatto (3, 6, 9, 12 mm).

TOSATRICE A BATTERIA TRIMOX PER RIFINITURE



Articolo	€ Listino	
8021385	33,49	4

• Inclusi accessori estesi con 3 pettini a scatto (3, 6, 9, mm).

LAMA RICAMBIO TOSATRICE TRIMOX



Articolo	€ Listino	
8021390	12,97	10

LAMA RICAMBIO PER TOSATRICE A BATTERIA



Articolo	€ Listino	
8021370	12,97	10

LAME RICAMBIO TOSATRICE DELOX



Articolo	€ Listino	
8021400	14,39	10

LAME RICAMBIO TOSATRICE DROPIX



Articolo	€ Listino	
8021380	12,97	10

STRIGLIA METALLO 8 BARRE DENTATE APERTE

• Pettine in metallo 8 barre aperte quadruplo cuscinetto a filo top coat incolore con manico in legno.



Articolo	€ Listino	
8021210	8,68	20

VALVOLA RICAMBIO SECCHIO AGNELLI



Articolo	€ Listino	
8021285	0,74	120

MORSA DI STRINGIMENTO METALLO PER APPLICAZIONE BANDE CASTRANTI



Articolo	€ Listino	
8021295	13,06	10

PER L'APPLICAZIONE DI BANDE CASTRANTI

SET 100 PEZZI ANELLO GOMMA MORSA DI STRINGIMENTO



Articolo	€ Listino	
8021300	3,46	40

TEST LATTE 1 LT - TEST DI MUNGITURA



Articolo	€ Listino	
8021160	9,26	8

• Indica lo stato della mammella molto prima che un cambiamento della qualità del latte diventi visibile a scaglie, sangue o dal suo assorbimento

PALETTA TEST MASTITE



Articolo	€ Listino	
8021165	4,72	15

SALDATORE BOVINI 320V CONNESSIONE DIRETTA DIRETTA 230 VOLT



Articolo	€ Listino	
8021170	113,24	1

• Inclusa Punta in acciaio inox Ø 18
 • Temperatura massima: 620 ° C
 • Lunghezza del cavo: 3 m



Per informazioni tecniche, foto e prezzi aggiornati visita il nostro sito www.cillisrl.com

PUNTA INOX 15 MM PER SALDATORE



Articolo	€ Listino	
8021175	11,94	10

RICAMBIO PER 8021170

ANTISUCCHIO PLASTICA REGOLABILE MEDIO



Articolo	€ Listino	
8021180	2,70	30

ANTISCALCIO ZINGATO



Articolo	€ Listino	
8021185	11,62	6

CALAMITA VERDE 35 X 35 X 100 MM



Articolo	€ Listino	
8021190	2,58	30

BENDA PER ZOCCOLI 35 X 35 X 100 MM



Articolo	€ Listino	
8021200	2,32	60

- Benda autoadesiva di medio-elastico.
- Max. 4,5 m di lunghezza estesa

BENDAGGIO PER ZOCCOLI KROMBERG 25M X 45MM



Articolo	€ Listino	
8021205	14,48	10

- Fasciatura protettiva per cavalli



PET



Per informazioni tecniche, foto e prezzi aggiornati visita il nostro sito www.cillisrl.com



Articolo		€ Listino	
8130100	1,5-4 Kg	30,90	10

• **Il prezzo è riferito ad ogni singola scatola da 4 pipette**
Azione repellente per 4 settimane contro pulci, zecche, zanzare e flebotomi (vettori della leishmaniosi canina)



Articolo		€ Listino	
8130102	4-10 Kg	31,76	10

• **Il prezzo è riferito ad ogni singola scatola da 4 pipette**
Azione repellente per 4 settimane contro pulci, zecche, zanzare e flebotomi (vettori della leishmaniosi canina)



Articolo		€ Listino	
8130104	10-20 Kg	35,36	10

• **Il prezzo è riferito ad ogni singola scatola da 4 pipette**
Azione repellente per 4 settimane contro pulci, zecche, zanzare e flebotomi (vettori della leishmaniosi canina)



Articolo		€ Listino	
8130106	20-40 Kg	38,96	8

• **Il prezzo è riferito ad ogni singola scatola da 4 pipette**
Azione repellente per 4 settimane contro pulci, zecche, zanzare e flebotomi (vettori della leishmaniosi canina)



Articolo		€ Listino	
8130108	40-60 Kg	44,28	8

• **Il prezzo è riferito ad ogni singola scatola da 4 pipette**
Azione repellente per 4 settimane contro pulci, zecche, zanzare e flebotomi (vettori della leishmaniosi canina)



Articolo		€ Listino	
8130350		Gratis	1

• **Gratis ogni 300€ di atiparassitari Virbac.**



Articolo		€ Listino	
8130202	2-10 Kg	27,30	20

• **Il prezzo è riferito ad ogni singola scatola da 4 pipette**
Azione repellente per 7 settimane contro pulci e 4 settimane contro zecche. Previene la moltiplicazione della pulci impedendo lo sviluppo delle uova.



Articolo		€ Listino	
8130204	10-20 Kg	30,14	20

• **Il prezzo è riferito ad ogni singola scatola da 4 pipette**
Azione repellente per 7 settimane contro pulci e 4 settimane contro zecche. Previene la moltiplicazione della pulci impedendo lo sviluppo delle uova.

Virbac

ANTIPARASSITARIO SET 4 PIPETTE EFFITIX CANE LARGE



Articolo		€ Listino	
8130206	20-40 Kg	34,06	20

• **Il prezzo è riferito ad ogni singola scatola da 4 pipette**
 Azione repellente per 7 settimane contro pulci e 4 settimane contro zecche. Previene la moltiplicazione della pulci impedendo lo sviluppo delle uova.

Virbac

ANTIPARASSITARIO SET 4 PIPETTE EFFIPRO DUO GATTO

• **Il prezzo è riferito ad ogni singola scatola da 4 pipette**
 Azione repellente per 5 settimane contro pulci (uova e larve) e 1 settimana contro le zecche.

Articolo		€ Listino	
8130200	1-6 Kg	24,50	20

Virbac

DUOWIN SPRAY

• **Il prezzo è riferito ad ogni singolo spray.**
 Soluzione spray repellente, insetticida larvicida ed ovocida per cani.

Effetto repellente contro zecche (30 giorni), pulci (60 giorni), zanzare e flebotomi (14 giorni). Non adatto sui gatti.



Articolo	ML	€ Listino	
8130300	250	36,45	12

Virbac

COLLARE ANTIPARASSITARIO READING GATTO

• **Il prezzo è riferito ad ogni singolo collare.** Confezione da 12 collari indivisibili. Compresa di espositore da banco.

Reading è il collare antiparassitario contro pulci e zecche fino a 4 mesi. Funziona anche se bagnato.



Articolo		€ Listino	
8130010	14 gr	10,78	12

Virbac

ANTIPARASSITARIO SET 4 PIPETTE EFFITIX CANE XLARGE



Articolo		€ Listino	
8130208	40-60 Kg	38,52	20

• **Il prezzo è riferito ad ogni singola scatola da 4 pipette**
 Azione repellente per 7 settimane contro pulci e 4 settimane contro zecche. Previene la moltiplicazione della pulci impedendo lo sviluppo delle uova.



Virbac

EFFIPRO SPRAY

• **Il prezzo è riferito ad ogni singolo spray.**
 Soluzione spray repellente, contro pulci e zecche per cani e gatti.

Effetto repellente nel cane, per pulci (90 giorni), zecche (30 giorni). Nel gatto per pulci (6 settimane), zecche (30 giorni). E' efficace anche nel trattamento dei pidocchi pungitori del cane e del gatto. Si può utilizzare su cuccioli e gattini a partire dalle 2 settimane.



Articolo	ML	€ Listino	1 box	2 box	
8130310	100	20,56	9,45	--	6
8130315	250	33,50	15,40	--	6

Virbac

COLLARE ANTIPARASSITARIO READING LONG ACTION GATTO

X1 collare 35 cm
Durata 8 mesi pulci e zecche



Articolo		€ Listino	
8130015		15,24	12

Per informazioni tecniche, foto e prezzi aggiornati visita il nostro sito www.cillisrl.com

Virbac

**COLLARE ANTIPARASSITARIO PER CANE
READING LONG ACTION SMALL**

**X1 collare
50 cm
Cani piccola e
media taglia**
Durata 10 mesi pulci e zecche.



Articolo	€ Listino	CFM
8130000	15,24	12

Virbac

**COLLARE ANTIPARASSITARIO PER CANE
READING LONG ACTION LARGE**

**X1 collare
70 cm
Cani di grande taglia**
Durata 10 mesi pulci e zecche.



Articolo	€ Listino	CFM
8130005	16,32	12

Virbac

COLLARE ANTIPARASSITARIO PREVENDOG S

**X1 collare
60 cm
Cani 0-25 kg**

Reading è il collare antiparassitario contro pulci, zecche e leishmaniosi. Funziona anche se bagnato.

- Durata 5 mesi zecche e leishmaniosi.
- Durata 4 mesi pulci.



Articolo	€ Listino	CFM
8130020	23,33	6

Virbac

COLLARE ANTIPARASSITARIO PREVENDOG S

**X2 collari
60 cm
Cani 0-25 kg**

Reading è il collare antiparassitario contro pulci, zecche e leishmaniosi. Funziona anche se bagnato.

- Durata 5 mesi zecche e leishmaniosi.
- Durata 4 mesi pulci.



Articolo	€ Listino	CFM
8130025	31,50	6

Virbac

COLLARE ANTIPARASSITARIO PREVENDOG L

**X1 collare
75 cm
Cani >25 kg**

Reading è il collare antiparassitario contro pulci, zecche e leishmaniosi. Funziona anche se bagnato.

- Durata 5 mesi zecche e leishmaniosi.
- Durata 4 mesi pulci.



Articolo	€ Listino	CFM
8130030	25,67	6

Virbac

COLLARE ANTIPARASSITARIO PREVENDOG L

**X2 collari
75 cm
Cani >25 kg**

Reading è il collare antiparassitario contro pulci, zecche e leishmaniosi. Funziona anche se bagnato.

- Durata 5 mesi zecche e leishmaniosi.
- Durata 4 mesi pulci.



Articolo	€ Listino	CFM
8130035	33,83	6

COLLARE GLAMOUR IN PELLE

VERA PELLE

Articolo	Lcm	Colore	€ Listino	
8151021	0,9x18-21	Nero	4,94	5
8151022	0,9x18-21	Blu	4,94	5
8151023	0,9x18-21	Rosso	4,94	5
8151024	0,9x18-21	Arancio	4,94	5
8151025	0,9x18-21	Verde	4,94	5
8151027	0,9x18-21	Rosa	4,94	5
8151028	0,9x18-21	Giallo	4,94	5
8151029	0,9x18-21	Viola	4,94	5
8150001	0,9x19-25	Nero	5,12	5
8150002	0,9x19-25	Blu	5,12	5
8150003	0,9x19-25	Rosso	5,12	5
8150004	0,9x19-25	Arancio	5,12	5
8150005	0,9x19-25	Verde	5,12	5
8150007	0,9x19-25	Rosa	5,12	5
8150008	0,9x19-25	Giallo	5,12	5
8150009	0,9x19-25	Viola	5,12	5
8150011	1,2x21-29	Nero	6,12	5
8150012	1,2x21-29	Blu	6,12	5
8150013	1,2x21-29	Rosso	6,12	5
8150014	1,2x21-29	Arancio	6,12	5
8150015	1,2x21-29	Verde	6,12	5
8150017	1,2x21-29	Rosa	6,12	5
8150018	1,2x21-29	Giallo	6,12	5
8150019	1,2x21-29	Viola	6,12	5
8150031	1,5x27-36	Nero	9,72	5
8150032	1,5x27-36	Blu	9,72	5
8150033	1,5x27-36	Rosso	9,72	5
8150034	1,5x27-36	Arancio	9,72	5
8150035	1,5x27-36	Verde	9,72	5
8150037	1,5x27-36	Rosa	9,72	5
8150038	1,5x27-36	Giallo	9,72	5
8150039	1,5x27-36	Viola	9,72	5
8150021	2x30-39	Nero	12,72	3
8150022	2x30-39	Blu	12,72	3
8150023	2x30-39	Rosso	12,72	3
8150024	2x30-39	Arancio	12,72	3
8150025	2x30-39	Verde	12,72	3
8150027	2x30-39	Rosa	12,72	3
8150028	2x30-39	Giallo	12,72	3
8150029	2x30-39	Viola	12,72	3
8151031	2,5x38-49	Nero	19,30	3
8151032	2,5x38-49	Blu	19,30	3
8151033	2,5x38-49	Rosso	19,30	3
8151034	2,5x38-49	Arancio	19,30	3
8151035	2,5x38-49	Verde	19,30	3
8151037	2,5x38-49	Rosa	19,30	3
8151039	2,5x38-49	Viola	19,30	3
8151041	3,5x46-60	Nero	29,24	3
8151042	3,5x46-60	Blu	29,24	3
8151043	3,5x46-60	Rosso	29,24	3
8151044	3,5x46-60	Arancio	29,24	3
8151045	3,5x46-60	Verde	29,24	3
8151047	3,5x46-60	Rosa	29,24	3
8151048	3,5x46-60	Giallo	29,24	3
8151049	3,5x46-60	Viola	29,24	3



COLLARE SOFT IN PELLE

VERA PELLE

Articolo	Lcm	Colore	€ Listino	
8150211	0,6x17-20	Nero	4,70	5
8150212	0,6x17-20	Blu	4,70	5
8150213	0,6x17-20	Rosso	4,70	5
8150214	0,6x17-20	Arancio	4,70	5
8150215	0,6x17-20	Verde	4,70	5
8150217	0,6x17-20	Rosa	4,70	5
8150218	0,6x17-20	Giallo	4,70	5
8150219	0,6x17-20	Viola	4,70	5
8150041	0,8x20-25	Nero	4,96	5
8150042	0,8x20-25	Blu	4,96	5
8150043	0,8x20-25	Rosso	4,96	5
8150044	0,8x20-25	Arancio	4,96	5
8150045	0,8x20-25	Verde	4,96	5
8150047	0,8x20-25	Rosa	4,96	5
8150048	0,8x20-25	Giallo	4,96	5
8150049	0,8x20-25	Viola	4,96	5
8150076	0,8x25-33	Marrone	5,52	5
8150051	0,8x25-33	Nero	5,52	5
8150052	0,8x25-33	Blu	5,52	5
8150053	0,8x25-33	Rosso	5,52	5
8150054	0,8x25-33	Arancio	5,52	5
8150055	0,8x25-33	Verde	5,52	5
8150057	0,8x25-33	Rosa	5,52	5
8150058	0,8x25-33	Giallo	5,52	5
8150059	0,8x25-33	Viola	5,52	5
8150061	1x33-41	Nero	8,32	5
8150062	1x33-41	Blu	8,32	5
8150063	1x33-41	Rosso	8,32	5
8150064	1x33-41	Arancio	8,32	5
8150065	1x33-41	Verde	8,32	5
8150067	1x33-41	Rosa	8,32	5
8150068	1x33-41	Giallo	8,32	5
8150069	1x33-41	Viola	8,32	5
8150087	1x33-41	Nero	8,32	5
8150086	1x33-41	Marrone	8,32	5
8150221	1x39-47	Nero	9,66	3
8150222	1x39-47	Blu	9,66	3
8150223	1x39-47	Rosso	9,66	3
8150224	1x39-47	Arancio	9,66	3
8150225	1x39-47	Verde	9,66	3
8150227	1x39-47	Rosa	9,66	3
8150228	1x39-47	Giallo	9,66	3
8150229	1x39-47	Viola	9,66	3
8150231	1,3x45-53	Nero	12,06	3
8150232	1,3x45-53	Blu	12,06	3
8150233	1,3x45-53	Rosso	12,06	3
8150234	1,3x45-53	Arancio	12,06	3
8150235	1,3x45-53	Verde	12,06	3
8150237	1,3x45-53	Rosa	12,06	3
8150238	1,3x45-53	Giallo	12,06	3
8150239	1,3x45-53	Viola	12,06	3
8150241	1,3x53-61	Nero	14,52	3
8150242	1,3x53-61	Blu	14,52	3
8150243	1,3x53-61	Rosso	14,52	3
8150244	1,3x53-61	Arancio	14,52	3
8150245	1,3x55-61	Verde	14,52	3
8150247	1,3x55-61	Rosa	14,52	3
8150248	1,3x55-61	Giallo	14,52	3
8150249	1,3x55-61	Viola	14,52	3



COLLARE STELLE CATARIFRANGENTE
IN PELLE



VERA
PELLE

Articolo	Lcm	Colore	€ Listino	
8151201	1,2x21-29	Nero	9,50	3
8151202	1,2x21-29	Blu	9,50	3
8151203	1,2x21-29	Rosso	9,50	3
8151204	1,2x21-29	Arancione	9,50	3
8151205	1,2x21-29	Verde	9,50	3
8151207	1,2x21-29	Rosa	9,50	3
8151208	1,2x21-29	Giallo	9,50	3
8151209	1,2x21-29	Viola	9,50	3
8151221	2x30-39	Nero	19,70	3
8151222	2x30-39	Blu	19,70	3
8151223	2x30-39	Rosso	19,70	3
8151224	2x30-39	Arancione	19,70	3
8151225	2x30-39	Verde	19,70	3
8151227	2x30-39	Rosa	19,70	3
8151228	2x30-39	Giallo	19,70	3
8151229	2x30-39	Viola	19,70	3
8151241	3,5x46-60	Nero	42,00	3
8151242	3,5x46-60	Blu	42,00	3
8151243	3,5x46-60	Rosso	42,00	3
8151244	3,5x46-60	Arancione	42,00	3
8151245	3,5x46-60	Verde	42,00	3
8151247	3,5x46-60	Rosa	42,00	3
8151248	3,5x46-60	Giallo	42,00	3
8151249	3,5x46-60	Viola	42,00	3



Per informazioni tecniche, foto e prezzi aggiornati visita il nostro sito www.cillisrl.com

COLLARE FIORI IN PELLE



VERA PELLE

Articolo	Lcm	Colore	€ Listino	
8150302	0,9x18-21	Blu	7,98	5
8150303	0,9x18-21	Rosso	7,98	5
8150305	0,9x18-21	Verde	7,98	5
8150307	0,9x18-21	Rosa	7,98	5
8150322	1,2x21-29	Blu	8,50	5
8150323	1,2x21-29	Rosso	8,50	5
8150325	1,2x21-29	Verde	8,50	5
8150327	1,2x21-29	Rosa	8,50	5
8150342	2x30-39	Blu	20,46	3
8150343	2x30-39	Rosso	20,46	3
8150345	2x30-39	Verde	20,46	3
8150347	2x30-39	Rosa	20,46	3
8150362	3,5x46-60	Blu	42,02	3
8150363	3,5x46-60	Rosso	42,02	3
8150365	3,5x46-60	Verde	42,02	3
8150367	3,5x46-60	Rosa	42,02	3

COLLARE GLAMOUR IN PELLE



VERA PELLE

Articolo	Lcm	Colore	€ Listino	
8150400	2x30-39	Multicolor	18,86	3
8150405	2,5x38-49	Multicolor	26,24	3
8150410	3,5x46-60	Multicolor	42,00	3



COLLARE GATTO FIORI



VERA PELLE

Articolo	Lcm	Colore	€ Listino	
8160001	0,9x22-30	Nero	12,16	3
8160003	0,9x22-30	Rosso	12,16	3
8160005	0,9x22-30	Verde	12,16	3

COLLARE GATTO



VERA PELLE

Articolo	Lcm	Colore	€ Listino	
8160021	0,9x17-20	Nero	5,44	5
8160022	0,9x17-20	Blu	5,44	5
8160023	0,9x17-20	Rosso	5,44	5
8160025	0,9x17-20	Verde	5,44	5
8160031	0,9x22-30	Nero	5,96	5
8160032	0,9x22-30	Blu	5,96	5
8160033	0,9x22-30	Rosso	5,96	5
8160035	0,9x22-30	Verde	5,96	5

COLLARE GATTO STRASS



VERA PELLE

Articolo	Lcm	Colore	€ Listino	
8160011	0,9x22-30	Nero	10,28	3
8160015	0,9x22-30	Verde	10,28	3

GUINZAGLIO GLAMOUR IN PELLE

cilli

VERA PELLE

Articolo	Lcm	Colore	€ Listino	
8150121	0,9x122	Nero	11,70	3
8150122	0,9x122	Blu	11,70	3
8150123	0,9x122	Rosso	11,70	3
8150124	0,9x122	Arancio	11,70	3
8150125	0,9x122	Verde	11,70	3
8150127	0,9x122	Rosa	11,70	3
8150128	0,9x122	Giallo	11,70	3
8150129	0,9x122	Viola	11,70	3
8150131	1,2x122	Nero	13,78	3
8150132	1,2x122	Blu	13,78	3
8150133	1,2x122	Rosso	13,78	3
8150134	1,2x122	Arancio	13,78	3
8150135	1,2x122	Verde	13,78	3
8150137	1,2x122	Rosa	13,78	3
8150138	1,2x122	Giallo	13,78	3
8150139	1,2x122	Viola	13,78	3
8160201	1,8x122	Nero	33,76	3
8160202	1,8x122	Blu	33,76	3
8160203	1,8x122	Rosso	33,76	3
8160204	1,8x122	Arancio	33,76	3
8160205	1,8x122	Verde	33,76	3
8160207	1,8x122	Rosa	33,76	3
8160208	1,8x122	Giallo	33,76	3
8160209	1,8x122	Viola	33,76	3
8160211	2,5x122	Nero	46,94	3
8160212	2,5x122	Blu	46,94	3
8160213	2,5x122	Rosso	46,94	3
8160214	2,5x122	Arancio	46,94	3
8160215	2,5x122	Verde	46,94	3
8160217	2,5x122	Rosa	46,94	3
8160218	2,5x122	Giallo	46,94	3
8160219	2,5x122	Viola	46,94	3



Per informazioni tecniche, foto e prezzi aggiornati visita il nostro sito www.cillisrl.com

GUINZAGLIO SOFT IN PELLE

VERA PELLE

Articolo	Lcm	Colore	€ Listino	
8150101	0,6x122	Nero	17,54	3
8150102	0,6x122	Blu	17,54	3
8150103	0,6x122	Rosso	17,54	3
8150104	0,6x122	Arancio	17,54	3
8150105	0,6x122	Verde	17,54	3
8150107	0,6x122	Rosa	17,54	3
8150108	0,6x122	Giallo	17,54	3
8150109	0,6x122	Viola	17,54	3
8150146	0,6x122	Marrone	17,54	3
8150111	0,8x122	Nero	22,94	3
8150112	0,8x122	Blu	22,94	3
8150113	0,8x122	Rosso	22,94	3
8150114	0,8x122	Arancio	22,94	3
8150115	0,8x122	Verde	22,94	3
8150117	0,8x122	Rosa	22,94	3
8150118	0,8x122	Giallo	22,94	3
8150119	0,8x122	Viola	22,94	3
8150156	0,8x122	Marrone	22,94	3
8150171	1x122	Nero	22,26	3
8150172	1x122	Blu	22,26	3
8150173	1x122	Rosso	22,26	3
8150174	1x122	Arancio	22,26	3
8150175	1x122	Verde	22,26	3
8150177	1x122	Rosa	22,26	3
8150178	1x122	Giallo	22,26	3
8150179	1x122	Viola	22,26	3
8160426	1x122	Marrone	22,26	3
8160436	1,3x122	Marrone	41,28	3



GUINZAGLIO CORTO SOFT IN PELLE

VERA PELLE

Articolo	Lcm	Colore	€ Listino	
8160461	1,3x55	Nero	29,46	3
8160466	1,3x55	Marrone	29,46	3



**GUINZAGLIO ALLUNGABILE
IN PELLE**

VERA
PELLE

Articolo	Lcm	Colore	€ Listino	
8160301	0,6x122-142-183	Nero	31,36	2
8160302	0,6x122-142-183	Blu	31,36	2
8160303	0,6x122-142-183	Rosso	31,36	2
8160304	0,6x122-142-183	Arancio	31,36	2
8160305	0,6x122-142-183	Verde	31,36	2
8160307	0,6x122-142-183	Rosa	31,36	2
8160308	0,6x122-142-183	Giallo	31,36	2
8160309	0,6x122-142-183	Viola	31,36	2
8160311	1x122-142-183	Nero	43,82	2
8160312	1x122-142-183	Blu	43,82	2
8160313	1x122-142-183	Rosso	43,82	2
8160314	1x122-142-183	Arancio	43,82	2
8160315	1x122-142-183	Verde	43,82	2
8160317	1x122-142-183	Rosa	43,82	2
8160318	1x122-142-183	Giallo	43,82	2
8160319	1x122-142-183	Viola	43,82	2
8160326	1x122-142-183	Marrone	43,82	2



**COLLARE GUINZAGLIO SEMISTROZZO
IN PELLE**

VERA
PELLE

Articolo	Lcm	Colore	€ Listino	
8160081	0,4x135	Nero	14,98	2
8160082	0,4x135	Blu	14,98	2
8160083	0,4x135	Rosso	14,98	2
8160084	0,4x135	Arancio	14,98	2
8160085	0,4x135	Verde	14,98	2
8160087	0,4x135	Rosa	14,98	2
8160088	0,4x135	Giallo	14,98	2
8160089	0,4x135	Viola	14,98	2
8160101	0,8x135	Nero	26,66	2
8160102	0,8x135	Blu	26,66	2
8160103	0,8x135	Rosso	26,66	2
8160104	0,8x135	Arancio	26,66	2
8160105	0,8x135	Verde	26,66	2
8160107	0,8x135	Rosa	26,66	2
8160108	0,8x135	Giallo	26,66	2
8160109	0,8x135	Viola	26,66	2
8160141	1,3x135	Nero	38,80	2
8160142	1,3x135	Blu	38,80	2
8160143	1,3x135	Rosso	38,80	2
8160145	1,3x135	Verde	38,80	2
8160147	1,3x135	Rosa	38,80	2
8160148	1,3x135	Giallo	38,80	2
8160149	1,3x135	Viola	38,80	2



**PETTORINA CON GUINZAGLIO SOFT
IN PELLE**

VERA
PELLE

Articolo	Lcm	Colore	€ Listino	
8152000	A:26-46 B:30-50	Turchese	27,82	3
8152001	A:26-46 B:30-50	Nero	27,82	3
8152002	A:26-46 B:30-50	Blu	27,82	3
8152003	A:26-46 B:30-50	Rosso	27,82	3
8152004	A:26-46 B:30-50	Arancione	27,82	3
8152005	A:26-46 B:30-50	Verde	27,82	3
8152007	A:26-46 B:30-50	Rosa	27,82	3
8152008	A:26-46 B:30-50	Giallo	27,82	3
8152009	A:26-46 B:30-50	Viola	27,82	3
8152010	A:42-60 B:46-64	Turchese	30,92	3
8152011	A:42-60 B:46-64	Nero	30,92	3
8152012	A:42-60 B:46-64	Blu	30,92	3
8152013	A:42-60 B:46-64	Rosso	30,92	3
8152014	A:42-60 B:46-64	Arancione	30,92	3
8152015	A:42-60 B:46-64	Verde	30,92	3
8152017	A:42-60 B:46-64	Rosa	30,92	3
8152018	A:42-60 B:46-64	Giallo	30,92	3
8152019	A:42-60 B:46-64	Viola	30,92	3



KIT COLLARI E GUINZAGLI COLLAR

VERA PELLE

Articolo	Lcm	Colore	
8149901	Miste	Nero-Blu-Rosso-Verde-Giallo	1



Collari presenti nel Kit

VERA PELLE

Articolo	Lcm	Colore	
8151021	9mm 18-21cm	Nero	1
8151022	9mm 18-21cm	Blu	1
8151023	9mm 18-21cm	Rosso	1
8150005	9mm 19-25cm	Verde	1
8150008	9mm 19-25cm	Giallo	1
8150011	12mm 21-29cm	Nero	1
8150012	12mm 21-29cm	Blu	1
8150013	12mm 21-29cm	Rosso	1
8150035	15mm 27-36cm	Verde	1
8150038	15mm 27-36cm	Giallo	1
8150021	20mm 30-39cm	Nero	1
8150022	20mm 30-39cm	Blu	1
8150023	20mm 30-39cm	Rosso	1
8151035	25mm 38-49cm	Verde	1
8151042	35mm 46-60cm	Blu	1
8151043	35mm 46-60cm	Rosso	1
8150215	17-20 cm	Verde	1
8150041	20-25cm	Nero	1
8150042	20-25cm	Blu	1
8150043	20-25cm	Rosso	1
8150055	25-33cm	Verde	1
8150058	25-33cm	Giallo	1
8150061	33-41cm	Nero	1
8150063	33-41cm	Rosso	1
8150225	39-47cm	Verde	1
8150228	39-47cm	Giallo	1
8150231	45-53cm	Nero	1
8150232	45-53cm	Blu	1
8150233	45-53cm	Rosso	1
8150245	53-61cm	Verde	1
8150248	53-61cm	Giallo	1

Guinzagli presenti nel Kit

VERA PELLE

Articolo	Lcm	Colore	
8150135	12mmx122cm	Verde	1
8150138	12mmx122cm	Giallo	1
8160203	18mmx122cm	Rosso	1
8160211	25mmx122cm	Nero	1
8160212	25mmx122cm	Blu	1
8150101	6mmx122cm	Nero	1
8150105	6mmx122cm	Verde	1
8150108	6mmx122cm	Giallo	1
8150113	8mmx122cm	Rosso	1
8150171	10mmx122cm	Nero	1
8150172	10mmx122cm	Blu	1
8160101	8mmx135cm	Nero	1
8160103	8mmx135cm	Rosso	1
8160141	13mmx135cm	Nero	1
8160142	13mmx135cm	Blu	1
8160143	13mmx135cm	Rosso	1



Per informazioni tecniche, foto e prezzi aggiornati visita il nostro sito www.cillisrl.com

COLLARE CUIO FODERATO CUCITO



VERA PELLE

Articolo	Lmm	€ Listino	
8200996	18x400	5,74	12
8201000	25x510	8,98	12
8201002	30x560	9,78	12
8201004	35x610	11,38	12
8201006	40x650	12,48	12

COLLARE CUIO FODERATO CON BORCHIE



VERA PELLE

Articolo	Lmm	€ Listino	
8201012	30x600	15,80	6
8201010	40x700	17,96	6

COLLARE CUIO FODERATO IMBOTTITO



VERA PELLE

Articolo	Lmm	€ Listino	
8201013	20x460	10,52	6
8201015	25x510	11,86	6
8201017	30x560	13,32	6
8201019	35x610	14,22	6

COLLARE CUIO SFODERATO TRECCIA



VERA PELLE

Articolo	Lmm	€ Listino	
8201092	12x330	2,22	12
8201093	14x350	2,62	12
8201094	16x410	3,18	12
8201095	18x400	3,82	12
8201096	20x440	4,85	12
8201097	25x510	5,50	12
8201098	30x560	6,80	12

COLLARE CUIO COLORATO SFODERATO



VERA PELLE

Articolo	Lmm	€ Listino	
8201150	12x330	1,15	24
8201152	16x370	1,62	24
8201154	20x440	2,90	12
8201156	25x510	3,24	12

COLLARE BUFALO



VERA PELLE

Articolo	Lmm	€ Listino	
8201020	12x330	2,26	24
8201022	16x370	3,10	24
8201024	20x440	4,26	24
8201026	25x510	5,60	24
8201028	30x560	6,26	12
8201029	35x610	9,12	12

COLLARE SCALETTA NICHELATO



Articolo	Lmm	€ Listino	
8201080	400	1,99	24
8201082	500	2,24	24
8201084	600	3,15	24

COLLARE IN NYLON COLORI ASSORTITI NON A SCELTA



Articolo	Lmm	€ Listino	
8201100	12x300	2,12	36
8201102	15x400	2,72	24
8201104	20x500	3,38	24
8201106	25x600	4,62	24

GUINZAGLIO DOPPIATRECCIA CUIO
COLORI ASSORTITI NON A SCELTA



VERA PELLE

Articolo	Lmm	€ Listino	
8201030	450	12,70	6

GUINZAGLIO TRECCIA CUIO CATENA
COLORI ASSORTITI NON A SCELTA



VERA PELLE

Articolo	Lmm	€ Listino	
8201035	600	14,90	6

GUINZAGLIO CUIO CON MOSCHETTONE
COLORI ASSORTITI NON A SCELTA



VERA PELLE

Articolo	Lmm	€ Listino	
8201045	13x1000	3,88	12

GUINZAGLIO NYLON TONDO STRANGOLO
COLORI ASSORTITI NON A SCELTA



Articolo	Lmm	€ Listino	
8201078	12x1300	12,78	12

GUINZAGLIO NYLON TONDO
COLORI ASSORTITI NON A SCELTA



Articolo	Lmm	€ Listino	
8201068	8x1100	11,02	12
8201070	12x1100	12,24	12

GUINZAGLIO IN NYLON
COLORI ASSORTITI NON A SCELTA



Articolo	Lmm	€ Listino	
8201060	12x1200	2,88	12
8201062	15x1200	4,06	12
8201064	20x1200	5,04	12
8201066	25x1200	6,92	12

Per informazioni tecniche, foto e prezzi aggiornati visita il nostro sito www.cillisrl.com

GUINZAGLIO AUTOMATICO



Articolo	Lmt	€ Listino	
8201250	5	5,00	24
8201260	8 doppio blister	7,00	24

GUINZAGLIO CATENA



Articolo	Lmm	€ Listino	
8200070	1600	2,40	60

PETTORINA IN NYLON PER CANI COLORI ASSORTITI NON A SCELTA



Articolo		€ Listino	
8201121	XS	5,50	12
8201122	S	7,48	12
8201123	M	10,95	6
8201124	L	14,83	6

PETTORINA IN CUOIO COLORI ASSORTITI NON A SCELTA



Articolo	Lmm	€ Listino	
8201114	10x1000	4,25	12
8201112	10x800	3,74	12
8201110	10x600	3,21	12

PETTORALE CUOIO CAMOSCIATO CON AGGANCIAMENTO ORIZZONTALE



Articolo	€ Listino	
8201126	66,93	4

PETTORALE IN CUOIO CON BORCHIE GRANDE COLORI ASSORTITI NON A SCELTA



Articolo	€ Listino	
8201130	59,61	4

PETTORALE IN CUOIO REGOLABILE CON AGGANCIAMENTO ORIZZONTALE



Articolo	€ Listino	
8201135	21,52	6

PARURE CON PETTORINA PELLE COLORI ASSORTITI NON A SCELTA



Articolo	Lmm	€ Listino	
8201140	10x400	14,00	12
8201141	10x500	14,00	12
8201142	10x600	14,00	12

**TIRAGRAFFI
MAKALU BASE IN LEGNO**



Articolo	Lcm	€ Listino	
8202150	35x35x65	42,30	2

**GIOCO PER CANE
CORDA PALLA**



Articolo	Colore	€ Listino	
8202030	Rosa	5,24	20
8202031	Giallo	5,24	20
8202032	Blu	5,24	20

**GIOCO PER CANE
CORDA NODO**



Articolo	Colore	€ Listino	
8202020	Rosa	6,70	10
8202021	Giallo	6,70	10
8202022	Blu	6,70	10

**GIOCO PER CANE
CORDA STECCO**



Articolo	Colore	€ Listino	
8202040	Rosa	7,52	10
8202041	Giallo	7,52	10
8202042	Blu	7,52	10

**GIOCO PER CANE
CORDA NODO**



Articolo	Tipo	€ Listino	
8202010	Volpe	8,66	10
8202011	Rana	8,66	10
8202012	Procione	8,66	10

**GIOCO SONORO
PER CANE COCCODRILLO**



Articolo	Colore	€ Listino	
8202014	Verde	6,52	10
8202015	Marrone	6,52	10

**GIOCO CANE
ARANCIONE SONORO**



Articolo	Lcm	€ Listino	
8202005	30	8,62	10

**GIOCO CANE
MARRONE SONORO**



Articolo	Lcm	€ Listino	
8202052	30	6,60	10



Per informazioni tecniche, foto e prezzi aggiornati visita il nostro sito www.cillisrl.com

**GIOCO CANE
ELEFANTE SONORO**



Articolo	Lcm	€ Listino	
8202054	30	8,62	10

**GIOCO CANE
COCCODRILLO SONORO**



Articolo	Lcm	€ Listino	
8202050	30	8,62	10

**GIOCO CANE
TALPA ERIZO SONORO**



Articolo	Lcm	€ Listino	
8202058	40	12,10	10

**GIOCO CANE
TALPA COSMO SONORO**



Articolo	Lcm	€ Listino	
8202060	40	12,10	10

**GIOCO CANE
TALPA ALPHONSO SONORO**



Articolo	Lcm	€ Listino	
8202062	40	12,10	10

GIOCO CANE POLLO SONORO



Articolo	Lcm	€ Listino	
8202070	42	11,18	10

GIOCO CANE ANATRA SONORO



Articolo	Lcm	€ Listino	
8202072	20	7,70	10

CESTA JAVA IN PLASTICA GRIGIO

• Cuscino non incluso



Articolo	Lcm	€ Listino	
8202160	48 x 33 x h 18	14,70	3
8202170	61 x 43 x h 23	21,90	3
8202180	78 x 52 x h 25	34,22	3
8202190	98 x 65 x h 30	53,18	3
8202200	120 x 75x h 35	79,78	3

CUSCINI PER CESTA JAVA GRIGIO SCURO



Articolo	Lcm	€ Listino	
8202300	35 x 24 x h 5	11,78	3
8202306	44 x 30 x h 6	14,52	3
8202312	62 x 38 x h 7	26,00	3
8202318	73 x 45 x h 13	34,90	3
8202324	87 x 50 x h 12	43,00	3

CUSCINI PER CESTA JAVA GRIGIO



Articolo	Lcm	€ Listino	
8202302	35 x 24 x h 5	11,78	3
8202308	44 x 30 x h 6	14,52	3
8202314	62 x 38 x h 7	26,00	3
8202320	73 x 45 x h 13	34,90	3
8202326	87 x 50 x h 12	43,00	3

CUSCINI PER CESTA JAVA GRIGIO



Articolo	Lcm	€ Listino	
8202304	35 x 24 x h 5	11,78	3
8202310	44 x 30 x h 6	14,52	3
8202316	62 x 38 x h 7	26,00	3
8202322	73 x 45 x h 13	34,90	3
8202328	87 x 50 x h 12	43,00	3

CUSCINO CESTO GRIGIO SCURO



Articolo	Lcm	€ Listino	
8202350	56 x 50 x h 12	42,18	2
8202356	82 x 61 x h 17	58,00	2
8202362	97 x 74 x h 16	83,50	2

CUSCINO CESTO GRIGIO



Articolo	Lcm	€ Listino	
8202354	56 x 50 x h 12	36,94	2
8202360	82 x 61 x h 17	58,00	2
8202366	97 x 74 x h 16	83,50	2

CUSCINO CESTO TURCHESE



Articolo	Lcm	€ Listino	
8202352	56 x 50 x h 12	36,94	2
8202358	82 x 61 x h 17	58,00	2
8202364	97 x 74 x h 16	83,50	2

TRASPORTINO VIAGGIO NERO GRIGIO

• L'articolo 8202520 e 8202515 è dotato di rotelle.



Articolo	Lcm	€ Listino	
8202500	48,3x32x25,4	23,42	4
8202505	58,4x38,7x33	34,32	2
8202510	68x47,6x42	48,16	2
8202515	81,3x56x58,5	80,60	2
8202520	91,5x61x66	107,50	2

Per informazioni tecniche, foto e prezzi aggiornati visita il nostro sito www.cillisrl.com

BOX LETTIERA NERO GATTO CON FILTRO ARIA



Articolo	Lcm	€ Listino	
8202130	42x50x42	27,70	3

BOX LETTIERA GATTO



Articolo	Lcm	Colore	€ Listino	
8202135	42,5x50x44,5	Verde	27,70	3
8202140	42,5x50x44,5	Turchese	27,70	3

LETTIERA GATTO CELESTE CON SETACCIO



Articolo	Lcm	€ Listino	
8202126	46x40x18	19,40	3

LETTIERA GATTO MEMPHIS S



Articolo	Lcm	Colore	€ Listino	
8202100	33,2x40,5x12	Turchese	5,64	4
8202102	33,2x40,5x12	Verde	5,64	4
8202104	33,2x40,5x12	Viola	5,64	4

LETTIERA GATTO MEMPHIS M



Articolo	Lcm	Colore	€ Listino	
8202110	39,5x49,2x15	Turchese	8,66	4
8202112	39,5x49,2x15	Verde	8,66	4
8202114	39,5x49,2x15	Viola	8,66	4

LETTIERA GATTO MEMPHIS L



Articolo	Lcm	Colore	€ Listino	
8202120	48x59x19	Turchese	12,18	4
8202122	48x59x19	Verde	12,18	4
8202124	48x59x19	Viola	12,18	4

PALETTA LETTIERA GATTO ROSSA



Articolo	€ Listino	
8202090	1,02	12

SPAZZOLA DOPPIO USO PER ANIMALI



Articolo	€ Listino	
8201200	4,48	12



MUSERUOLA CON CINTURINO IN CUOIO



VERA PELLE

Articolo	Lcm	€ Listino	
8201263	8x7,5x5,5	5,96	12
8201265	10x9,5x6,5	7,00	12
8201267	12x11x7,5	8,36	12
8201269	14x12x10	9,50	12

MUSERUOLA FISSA NYLON EXTREME



Articolo	Tg	€ Listino	
8203001	1	3,60	4
8203002	2	3,60	4
8203003	3	4,00	4
8203004	4	4,26	4
8203005	5	4,44	4
8203006	6	4,44	4
8203007	7	4,62	4

MUSERUOLA REGOLABILE NYLON EXTREME



Articolo	Tg	€ Listino	
8203011	1	4,42	4
8203012	2	4,78	4
8203013	3	5,40	4

MUSERUOLA NYLON PER GATTO



Articolo	Tg	€ Listino	
8203021	1	4,04	4
8203022	2	4,04	4
8203023	3	4,04	4

COLLARE ELISABETTIANO RIGIDO



Articolo	Tg	Lcm	€ Listino	
8203061	1	22-25x10,5	10,08	4
8203062	2	26-31x13	11,64	4
8203063	3	32-38x15,5	15,48	4
8203064	4	38-44x20,5	19,20	2
8203065	5	44-50x25	24,72	2
8203066	6	47-57x30	30,23	2

COLLARE ELISABBETTIANO MORBIDO



Articolo	Tg	Lcm	€ Listino	
8203051	1	22-25x10,5	10,45	4
8203052	2	26-31x13	11,88	4
8203053	3	32-38x15,5	15,20	4
8203054	4	38-44x20,5	18,58	2
8203055	5	44-50x25	23,50	2
8203056	6	47-57x30	28,44	2

Per informazioni tecniche, foto e prezzi aggiornati visita il nostro sito www.cillisrl.com

DISPENSER SACCHETTI IGIENICI



Articolo	€ Listino	
8202000	4,50	12

• Inclusi 2 rotoli di sacchetti. Ogni rotolo contiene 15 bustine.

SACCHETTI IGIENICI 4 PZ



Articolo	€ Listino	
8202002	3,48	24

• Ogni rotolo contiene 15 bustine.

SACCHETTI IGIENICI 4 PZ PROFUMATI



Articolo		€ Listino	
8202004	Limone	3,48	24
8202006	Rosa	3,48	24
8202008	Lavanda	3,48	24

• Ogni rotolo contiene 15 bustine.

CIOTOLA DOPPIA BIANCA PICCOLI ANIMALI



Articolo	Capienza	€ Listino	
8211200	2 x 350 ml	8,52	6
8211205	2 x 800 ml	13,90	6
8211210	2 x 1700 ml	19,00	3

CIOTOLA DOPPIA BIANCA CON SUPPORTO



Articolo	Capienza	€ Listino	
8211220	2 x 350 ml	13,26	6
8211225	2 x 800 ml	20,52	6
8211230	2 x 1700 ml	25,76	3

MANGIATOIA PICCOLI ANIMALI



Articolo	Ø	€ Listino	
8211101	17 cm	1,30	60

MANGIATOIA CANI MEDI



Articolo	Lcm	€ Listino	
8211105	32x32x38	5,20	12

MANGIATOIA CANI GRANDI



Articolo	Lcm	€ Listino	
8211108	41x41x27	6,80	12



DISINFESTAZIONE



Per informazioni tecniche, foto e prezzi aggiornati visita il nostro sito www.cillisrl.com

ESCA TOPICIDA PASTA FRESCA



Articolo	Kg	€ Listino	
8100050	0,150	1,89	100
8100070	1,500	9,52	20

• L'esca topicida è un'esca per uso domestico e civile. Uccide con una sola ingestione, efficace anche se è assunto in piccola dose. Per tutti i tipi di roditori.

ESCA TOPICIDA IN GRANO



Articolo	Kg	€ Listino	
8100092	0,140	2,24	100
8100102	1,500	9,80	36

• Molto resistente all'acqua e umidità. Con foro centrale per fissaggio. Ideale per l'uso con portaesche Masterbox.

ESCA BLOCK TOPICIDA PARAFINATO PER ESTERNI



Articolo	Kg	€ Listino	
8100025	0,300	7,84	48

• Molto resistente all'acqua e umidità. Con foro centrale per fissaggio. Ideale per l'uso con portaesche Masterbox.

COLLA TOPICIDA



Articolo	Kg	€ Listino	
8100110	0,135	1,64	50

• Colla per topi, ratti, serpenti, lucertole, insetti ecc.. Spalmata sui tronchi delle piante le preserva da attacchi di insetti che risalgono il terreno. NON VELENOSA.

ULTRASUONI FIORE RODITORI SOLARE



Articolo	€ Listino	
8200525	14,00	12

• Allontana e previene le infestazioni di TALPE e RODITORI. Innocuo per l'uomo. COPERTURA FINO A 800 mq.

ULTRASUONI TALPE E RODITORI ECO SOLARE



Articolo	€ Listino	
8200520	18,80	12

• Ultrasuoni per talpe ed arvicole ad energia solare che inserito nel terreno, produce vibrazioni ad intervalli regolari di 20-25 secondi. Le talpe e le arvicole risultano così infastidite ed abbandonano i luoghi infestati. Non necessita di batterie grazie al pannello solare che lo ricarica automaticamente durante il giorno.

ULTRASUONI TALPE E RODITORI 2 PILE (NON INCLUSE)



Articolo	€ Listino	
8200530	12,20	12

• Ultrasuoni per talpe ed arvicole che, inserito nel terreno, produce vibrazioni ad intervalli regolari di 20-25 secondi. Le talpe e le arvicole risultano così infastidite ed abbandonano i luoghi infestati. E' efficace su un raggio di 25m, coprendo una superficie di 750 m² a seconda del terreno. Si utilizzano 2 PILE "AA" (non incluse)

DERATTIZZATORE TOPI ELETTRONICO



Articolo	€ Listino	
8200660	42,00	6

• Frequenza variabile: la frequenza di 2 onde e la variabilità della stessa, fanno sì che i topi non si adattino al suono. Raggio di azione: 100mt. Non è nocivo per l'essere umano.

ULTRASUONI TOPI SCARAFAGGI E ZANZARE



Articolo	€ Listino	
8200665	17,00	12

• Tensione 220V. Frequenza 30-70 KHZ.
Area di effetto fino a 400 mq in area libera.

TRAPPOLA PER TOPI METALLO



Articolo	Lmm	€ Listino	
8200205	120x55	0,65	60
8200210	165x99	1,00	72

TRAPPOLA A BLOCCO 2 INGRESSI 2 PORTE PER TOPI



Articolo	Lmm	€ Listino	
8200265	215x305x25	5,04	9

TRAPPOLA PER TOPI USA E GETTA



Articolo	Lmm	€ Listino	
8200270	290x205x42	1,76	48

cilli

DERATTIZZATORE TOPI ELETTRONICO



Articolo	€ Listino	
8200600	226,26	2

eco-contributo rae € 0,14+IVA
• Questo particolare sistema consente l'emissione di ultrasuoni ad una frequenza variabile automaticamente da 20 a 50 khz con l'efficienza di 106 dB ad 1 metro; la superficie di azione si intende di circa 250 mq senza ostacoli. Le frequenze di emissione degli ultrasuoni sono tali da non essere percepite dall'uomo.

TRAPPOLA PER TOPI



Articolo	Lmm	€ Listino	
8200230	200x90x95	7,50	24
8200240	300x140x130	13,00	12
8200250	400x180x175	20,00	12

• Trappola a gabbia in ferro per topi. Il portello di chiusura è direttamente collegato al sistema di puntamento ad esca.

TRAPPOLA PER RATTI



Articolo	Lmm		Ø	€ Listino	
8200275	270	0,041	139-110	9,66	16

TRAPPOLA PER TOPI A CUPOLA TRE INGRESSI



Articolo	Lmm	€ Listino	
8200260	175x345x510	3,52	12

**DISTRIBUTORE PER
ESCA TOPICIDA**



Articolo	Lmm	Kg	€ Listino	
8200220	465x170x270	1,100	18,08	8

• Il distributore per esca topicida, realizzato in lamiera zincata, si utilizza per posizionare l'esca topicida nei casi in cui è necessario rendere difficoltoso l'accesso all'esca da partedi altri animali.

**CONTENITORE ESCA TOPICIDA
PICCOLO CE HACCP**



Articolo	Lmm	€ Listino	
8200280	80x130	2,48	50

• Chiave di apertura inclusa

**CONTENITORE ESCA TOPICIDA
MEDIO CE HACCP**



Articolo	Lmm	€ Listino	
8200285	130X190	9,95	36

• Chiave di apertura inclusa

**CONTENITORE ESCA TOPICIDA
GRANDE CE HACCP**



Articolo	Lmm	€ Listino	
8200290	160x240	13,00	12

• Chiave di apertura inclusa

**TRAPPOLA BORA BLOCBOX RATTI
32,5 X 25 X 16 CM**



Articolo	€ Listino	
8021250	12,54	15

• Fatto di plastica robusta. • Chiudibile a chiave con chiave per tenere lontane le esche da bambini e animali domestici.

**TRAPPOLA BORA BLOCBOX RATTI
22,5 X 18,5 X 9,5 CM**



Articolo	€ Listino	
8021255	10,34	15

• Fatto di plastica robusta. • Chiudibile a chiave con chiave per tenere lontane le esche da bambini e animali domestici.

**TRAPPOLA ALPHA BLOCBOX RATTI
23 X 10,5 X 10 CM**



Articolo	€ Listino	
8021260	7,42	15

• Fatto di plastica robusta. • Chiudibile a chiave con chiave per tenere lontane le esche da bambini e animali domestici.

**TRAPPOLA PETI BLOCBOX TOPI
12,5 X 9,5 X 4,5 CM**



Articolo	€ Listino	
8021265	1,74	72

• Fatto di plastica robusta. • Chiudibile a chiave con chiave per tenere lontane le esche da bambini e animali domestici.

Per informazioni tecniche, foto e prezzi aggiornati visita il nostro sito www.cillisrl.com

Creolina

CREOLINA ORIGINALE

Articolo	Ml	€ Listino	CFM
8100075	1000	14,70	12

• La CREOLINA® è dotata di alta efficacia germicida con il più ampio spettro batterico, comprendente sia i germi Gram positivi che Gram negativi. Essa è pure attivissima contro il Mycobacterium Tuberculosis sia umano che bovino.



ANTIFORMICHE IN POLVERE



Articolo	Kg	€ Listino	CFM
8104260	0,200	4,30	48
8104265	1	9,00	20

• Neodust è un insetticida in polvere leggerissima pronta all'uso per la lotta contro insetti striscianti. Può essere usato efficacemente per la disinfestazione di edifici civili, industriali, agricoli e mezzi di trasporto.

ULTRASUONI ANTIZANZARE 220V 0,5W



Articolo	€ Listino	CFM
8200510	3,30	144

TRAPPOLA ADESIVA PER SCARAFAGGI HACCP



Articolo	Lmm	€ Listino	CFM
8200295	100x180	1,40	40

• Geotrap scarafaggi è una trappola adesiva con supporto in cartoncino per la cattura di scarafaggi, formiche, blatte e altri insetti striscianti.

FIAMMA CITRONELLA ALLUMINIO



Articolo	Ø	€ Listino	CFM
4300740	110x20 mm	0,66	120
4300751	140x20 mm	1,14	72
4300755	165x25 mm	1,44	72

FIAMMA CITRONELLA COCCIO



Articolo	Ø	€ Listino	CFM
4300730	145x40 mm	1,54	60

OLIO ALLA CITRONELLA PER TORCE



Articolo	Lt	€ Listino	CFM
4300580	1	4,80	12

ESCA LUMACHICIDA



Articolo	Kg	€ Listino	
8104275	1,000	4,80	20

• Questa esca è formulata con particolari supporti che servono per attirare lumache, limacce e chioccioline. Agisce per contatto e ingestione. Grazie alla sua formulazione è di facile impiego.

TRAPPOLA LUMACHE E LIMACCE ESAGONALE



Articolo	€ Listino	
8017000	4,20	36

• OTTIMA PROTEZIONE PER ORTAGGI, PIANTE E FIORI. Basta aggiungere birra all'interno della trappola per attrarre lumache e limacce, che non riusciranno più ad uscire.

KIT 25 DISSUASORI FLESSIBILI INOX 80 SPILLI

Articolo	€ Listino	
8110020	76,00	2

• Acciaio INOX Aisi 304. Kit di 25 barre da 1 mt



NASTRO SPAVENTAPASSERI 40MT

Articolo	Lmm	€ Listino	
8104300	50	3,00	36



TRAPPOLA PER VESPE



Articolo	€ Listino	
8200420	4,00	36

TRAPPOLA PER VESPE E MOSCHE



Articolo	€ Listino	
8017010	4,34	24

• Trappola per insetti in materiale plastico. Questa semplicissima trappola ecologica permette di catturare gli insetti, i quali vengono attirati all'interno dal profumo di un liquido (come vino, latte o sciroppo) che verrà precedentemente immesso.

Per informazioni tecniche, foto e prezzi aggiornati visita il nostro sito www.cillisrl.com

SET 2 PEZZI TRAPPOLA PER INSETTI PER VASI DA 1 KG



Articolo	€ Listino	
8017020	4,76	15

• Vaso Trap è la trappola per mosche della frutta, mosche comuni, calabroni, vespe, e vari tipi di insetti nocivi volanti. È una trappola cromotropica a esca alimentare, facile da preparare in casa, riciclando i vasi del miele da 1 kg.

SET 5 PEZZI TRAPPOLA INSETTI PER BOTTIGLIE DI PLASTICA COMUNI



Articolo	€ Listino	
8017015	8,40	12

• Trap Trap è la trappola per mosche della frutta, mosche comuni, calabroni, vespe, e vari tipi di insetti nocivi volanti. È una trappola cromotropica a esca alimentare, facile da preparare in casa, riciclando delle comuni bottiglie di plastica.

SET 2 PEZZI TRAPPOLA PER INSETTI PER VASI DA 1 KG



Articolo	€ Listino	
8017021	4,76	15

• Vaso Trap è la trappola per mosche della frutta, mosche comuni, calabroni, vespe, e vari tipi di insetti nocivi volanti. È una trappola cromotropica a esca alimentare, facile da preparare in casa, riciclando i vasi del miele da 1 kg.

SET 5 PEZZI TRAPPOLA INSETTI PER BOTTIGLIE DI PLASTICA COMUNI



Articolo	€ Listino	
8017016	8,40	12

• Trap Trap è la trappola per mosche della frutta, mosche comuni, calabroni, vespe, e vari tipi di insetti nocivi volanti. È una trappola cromotropica a esca alimentare, facile da preparare in casa, riciclando delle comuni bottiglie di plastica.

SFERA TRAPPOLA INSETTI COMOTROPICA LUMINOSA



Articolo	€ Listino	
8017025	20,20	6

• Sfera Trap è una trappola cromotropica luminosa a colla per insetti volanti dannosi. Grazie alla sua luminosità notturna, è attiva giorno e notte e può catturare mosche, zanzare, tafani, mosche cavalline, mosche della frutta, vespe, calabroni, lepidotteri, ecc., in interni ed esterni.





ANTINFORTUNISTICA



OCCHIALI DA LETTURA SFUSI SINGOLI

zippo



no. 3070001 (31Z-81-BLK300) +3.00



no. 3070002 (31Z-81-BLU250) +2.50



no. 3070003 (31Z-81-BRD350) +3.50



no. 3070004 (31Z-81-RED200) +2.00



no. 3070013 (31Z-86-BLK200) +2.00



no. 3070014 (31Z-86-BLU250) +2.50



no. 3070015 (31Z-86-DEM350) +3.50



no. 3070016 (31Z-86-RED300) +3.00



no. 3070005 (31Z-83-GRE150) +1.50



no. 3070006 (31Z-83-ORA300) +3.00



no. 3070007 (31Z-83-WHI100) +1.00



no. 3070008 (31Z-83-YEL350) +3.50



no. 3070017 (31Z-816-BLK150) +1.50



no. 3070018 (31Z-816-BLU100) +1.00



no. 3070019 (31Z-816-BRD300) +3.00



no. 3070020 (31Z-816-RED350) +3.50



no. 3070009 (31Z-84-BLK200) +2.00



no. 3070010 (31Z-84-BLU150) +1.50



no. 3070011 (31Z-84-CAM100) +1.00



no. 3070012 (31Z-84-RED250) +2.50



no. 3070021 (31Z-820-BDE100) +1.00



no. 3070022 (31Z-820-BLK200) +2.00



no. 3070023 (31Z-820-NDE150) +1.50



no. 3070024 (31Z-820-ROE250) +2.50



Logo Zippo® sull'esterno delle aste
Zippo® logo on outside temples



Aste con sistema Flex®
Flex system temples

€ Listino

9,90

PACKAGING PER OCCHIALI DA LETTURA

Custodia nera satinata, pezzuola in microfibra e cordino.

OCCHIALI ESCLUSI



Articolo	€ Listino	
3059000	1,00	1

PRE-PACK 24 OCCHIALI DA LETTURA

24 occhiali da lettura (come illustrato) con espositore girevole da banco

- 4 pz. / pcs. +1.00
- 4 pz. / pcs. +1.50
- 4 pz. / pcs. +2.00
- 4 pz. / pcs. +2.50
- 4 pz. / pcs. +3.00
- 4 pz. / pcs. +3.50

1 pezzo per ciascuno dei 24 modelli.

Espositore incluso.

Dimensioni espositore:
24 x 24 x 55 cm



Articolo	€ Listino	
3070000	237,60	

OCCHIALI CON VALVOLINE CE EN 166



Articolo	€ Listino	
3081005	6,00	60

OCCHIALI CON VALVOLINE CE EN 166



Articolo	€ Listino	
3081000	2,76	60

OCCHIALI ANTIAPPANNANTI CON FORI CE EN 166



Articolo	€ Listino	
3081020	3,90	72

OCCHIALI CON STANGHETTA TRASPARENTE CE EN 166



Articolo	€ Listino	
3081045	2,28	60

OCCHIALI CON STANGHETTA LENTI BIANCHE CE EN 166



Articolo	€ Listino	
3081050	2,20	36

OCCHIALI CON STANGHETTA LENTI GIALLE CE EN 166



Articolo	€ Listino	
3081055	2,20	72

OCCHIALI PER SALDATORI EN 175



Articolo	€ Listino	
3081010	4,00	36

CASCHETTO CON VISIERA CE EN 166



Articolo	€ Listino	
3082050	8,86	24

VISIERA TRASPARENTE CE EN 166



Articolo	€ Listino	
3081075	4,30	40

VISIERA PROTETTIVA COMBINATA PROFESSIONALE EN166 EN1731



Articolo	€ Listino	
3081400	6,38	10

VISIERA CON RETE A NORMA CE EN 1731



• Visiera sollevabile

Articolo	€ Listino	
3081060	4,58	40



CASCHETTO CON RETE A NORMA CE EN 1731



• Visiera sollevabile



Articolo	€ Listino	
3082060	12,00	24

ELMETTO PROTETTIVO CON VISIERA + CUFFIE EN1731, EN397, EN352



Articolo	€ Listino	
3081420	27,88	5

ELMETTO GIALLO CE EN397:1995



Articolo	€ Listino	
3081955	4,80	12

CUFFIA ANTIRUMORE EM 913 EN 352-1 ANSI 53.19



Articolo	€ Listino	
3081840	5,00	12

SEMIMASCHERA ATTACCO RAPIDO CON DUE FILTRI IN DOTAZIONE

Semimaschera di taglia universale conforme alla norma Europea EN 140:1998, in accordo alla Direttiva 89/686/CEE, dotata di due raccordi rapidi a baionetta, idonea per la protezione da polveri sia grossolane che sottili, da gas e vapori organici, inorganici, acidi e combinazioni di gas e polveri. Impareggiabile comfort, leggerezza e adattabilità ad ogni configurazione del viso grazie al nuovo profilo dell'oronasale studiato con tecnologia Cad-Cam. Il nuovo sistema di 4 cinghioni, bilancia la pressione nella zona di tenuta del viso eliminando i punti di pressione e garantendo una stabilità eccezionale durante l'impiego.

PRO  

Articolo	Tipo	€ Listino	
3085200	A1-P2	37,40	9
3085210	A1-B1-E1-K1-P2	39,80	9



SEMIMASCHERA CON ATTACCO RAPIDO A DUE FILTRI



PRO  

Articolo	€ Listino	
3085250	12,90	16



FILTRO PER SEMIMASCHERA



PRO  

Articolo	Tipo	€ Listino	
3085305	A1	5,28	6
3085300	A1-B1-E1-K1	7,50	6

• Per maschere 3085200-3085210-3085250

GRUPPO SCUDO CON ELASTICI E RIVETTI PER MASCHERA



PRO  

Articolo	€ Listino	
3085177	20,15	1

• Per maschere 3085200-3085210-3085250

SET 2 PREFILTRI PER SEMIMASCHERA



PRO  

Articolo	Tipo	€ Listino	
3085308	P2	5,80	8

• Dischetto filtrante per filtri antipolvere P2.
Per maschere 3085200-3085210-3085250

COPERCHIO PREFILTRO PER SEMIMASCHERA



PRO  

Articolo	€ Listino	
3085310	3,15	8

• Speciale coperchio di bloccaggio utilizzabile su semimaschera da applicare sui filtri base.
Per maschere 3085200-3085210-3085250



**SEMIMASCHERA PER 2 FILTRI
CE EN 140:1998**

Semimaschera di taglia universale, dotata di due raccordi filettati, idonea per la protezione da polveri sia grossolane che sottili, da gas e vapori organici, inorganici, acidi e combinazioni di gas e polveri. Il suo utilizzo trova impiego nella lavorazione del legno, marmi, verniciatura a spruzzo e/o a pennello, molatura, hobbistica, trattamenti con fitofarmaci, ecc... Dotata di valvola di espirazione in morbido silicone, montata su una base di materiale plastico molto resistente e protetta da un coperchio a scatto. La semimaschera può essere utilizzata in combinazione con i filtri 3085110 e 3085120.

Misura: unica Peso: 120 gr
CE EN 140

PRO  

Articolo	€ Listino	
3085100	16,40	16



**SEMIMASCHERA PER 1 FILTRO
CE EN 140:1998**

Semimaschera di taglia universale, dotata di un raccordo filettato, idonea per la protezione da polveri sia grossolane che sottili. Il suo utilizzo trova impiego nella lavorazione del legno, dei marmi, nelle operazioni di sverniciatura, molatura e nell'hobbistica in genere. Dotata di valvola di espirazione in morbido silicone, montata su una base di materiale plastico molto resistente e protetta da un coperchio a scatto. La semimaschera può essere utilizzata in combinazione con i filtri 3085110 e 3085120.

Misura: unica Peso: 115 gr
CE EN 140

ATTENZIONE: LA SEMIMASCHERA NON E' COMPRESA DI FILTRO

PRO  

Articolo	€ Listino	
3085010	15,70	16



FILTRO CE EN 141



PRO  

Articolo	Tipo	€ Listino	
3085110	A1	4,98	24
3085120	A1-P2 R	8,80	24
3085130	A1-B1-E1-K1	8,90	24

• Per maschere 3085100-3085010

**VALVOLA ISPIRAZIONE 1 PZ
PER SEMIMASCHERE N°4**

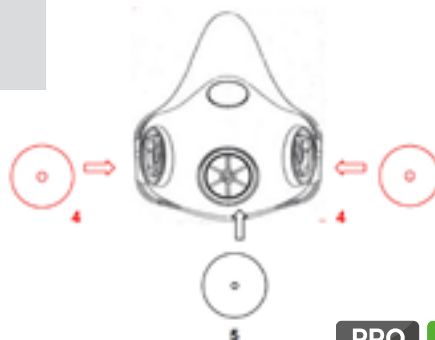

PRO  

Articolo	€ Listino	
3085175	2,24	1

• Per maschere 3085200-3085210-3085250-3085100-3085010

**MASCHERA PANORAMICA 1 ATTACCO
CE EN 136 CLASSE 2**

• Maschera con attacco filettato unificato EN148-1.

Maschera intera a pressione negativa di taglia universale
Facciale esterno in morbido Silicone, Dotata di fibbie di regolazione a bloccaggio automatico con sblocco semplice e veloce. Schermo panoramico in Policarbonato con trattamento antigraffio all'esterno e sistema antiappannamento della circolazione dell'aria all'interno. Gruppo valvolare che riunisce in un solo corpo il raccordo filettato EN 148-1, la valvola di espirazione, il dispositivo fonico, la guarnizione porta valvola e la valvola di inspirazione. La maschera può essere utilizzata in combinazione con i filtri dotati dello stesso raccordo filettato EN148-1. Filtro NON incluso Trova il suo impiego ideale nell'Industria chimica, petrolchimica e nelle raffinerie, trattamenti intensivi con fitofarmaci,rotezione dai fumi da Incendio Boschivo, trattamento e smaltimento di amianto e materiali contaminati da radionuclidi.



PRO 

Articolo	€ Listino	
3089005	126,00	2

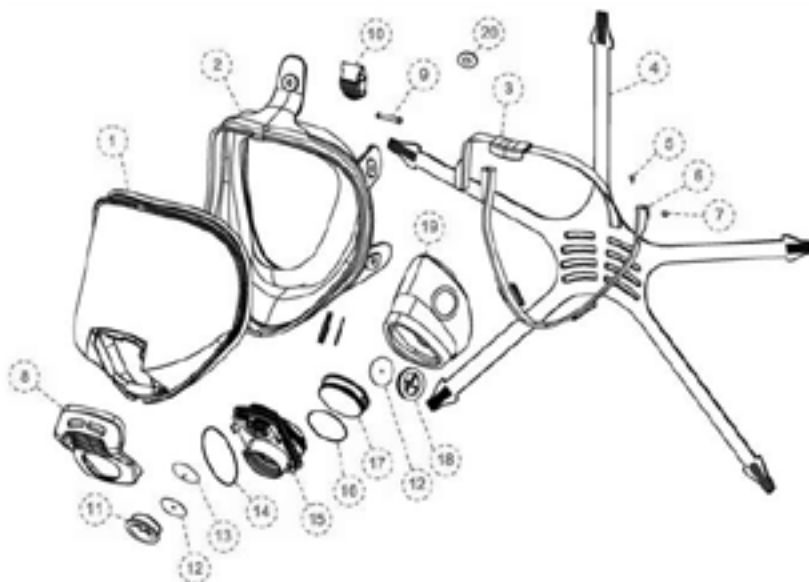

N°	CODICE	DESCRIZIONE	LISTINO	Q.tà	N°	CODICE	DESCRIZIONE	LISTINO	Q.tà
2	3085174	ELASTICO NERO PER SEMIMASCHERE	1,66	1	12	3085165	VALVOLA INSPIRAZIONE IN SILICONE	2,80	1
3	3085176	TESTIERA SEMIMASCHERA BLU	3,32	1	13	3085160	VALVOLA ESPIRAZIONE IN SILICONE	5,04	1
4	3085170	BORDATURA A 5 PUNTI PER MASCHERA	19,00	1	16	3085167	OR 3187 PER MEMBRANA FONICA	4,14	1
8	3085169	SCUDO GRUPPO CENTRALE PA 6	5,52	1	17	3085166	MEMBRANA FONICA PP NERO	2,49	1
9-10-20	3085161	FUNGHETTO+RULLINO+FIBBIA PA6	2,49	1	18	3085164	PORTAVALVOLA ORONASALE PP NERO	1,70	1
11	3085162	GUARNIZIONE VALVOLA INSPIRAZIONE	4,14	1	19	3085163	ORONASALE INTERNO SILICONE NERO	11,04	1

FILTRO 300 ABEK POLIVALENTE EN 141



PRO 

Articolo	Tipo	€ Listino	
3089030	A2B2E2K2	19,50	6
3089060	A2B2E2K2P3 R	23,00	12

**BORSA PER MASCHERA
PANORAMICA 3089005**



PRO 

Articolo	€ Listino	
3089007	40,42	1

• Per maschera 3089005

• Per maschera 3089005

Per informazioni tecniche, foto e prezzi aggiornati visita il nostro sito www.cillisrl.com

**MASCHERA A1P3 FACCIALE BLU
TAGLIA M/L**

PRO

Articolo	€ Listino	
3087020	37,50	4



Semimaschera protezione gas e polveri

PROTEZIONE

Il respiratore per gas e vapori è munito di due elementi filtranti a carboni attivi che, grazie all'elevata porosità ed alla superficie specifica, sono capaci di assorbire e condensare le sostanze nocive. Quando i filtri sono esauriti possono essere sostituiti con i filtri di ricambio.

Il respiratore è adatto per vapori e gas organici, polveri e nebbie. Protezione polivalente per sostanze in concentrazioni fino a 1,000 ppm e da polveri e nebbie fino a 50 TLV.

CAMPI DI APPLICAZIONE

A1P3 Verniciatura a solventi in automotive, cantieri navali ed officine di riparazione. Utilizzata anche nell'ambito delle costruzioni.

CERTIFICAZIONI

Maschera conforme alla norma EN140:1998 Filtri conformi alla norma EN 14387: (RD). Maschere senza manutenzione conformi alla norma EN405 (RD). Maschera e filtri sono certificati CE

**MASCHERA INTEGRA A1P3
TAGLIA M/L**

PRO

Articolo	€ Listino	
3087030	84,00	2



Semimaschera protezione gas e polveri

PROTEZIONE

Le lenti sono in policarbonato ed hanno una resistenza ad impatti di 45 metri al secondo. Il rivestimento applicato sulla visiera rispetta lo standard (N) Anti Appannamento e supera lo standard (K) antigraffio. Il respiratore per gas e vapori è munito di due elementi filtranti a carboni attivi che, grazie all'elevata porosità ed alla superficie specifica, sono capaci di assorbire e condensare le sostanze nocive.

Quando i filtri sono esauriti possono essere sostituiti con i filtri di ricambio. Il respiratore è adatto per vapori e gas organici, polveri e nebbie.

CAMPI DI APPLICAZIONE

Miniera, acciaierie, fonderie, meccanica, farmaceutica, cementifici, vetrerie, ceramica, industria tessile, cantieri navali, produzione batterie, eliminazione rifiuti tossici, amianto.

CERTIFICAZIONI

Maschera Integra (con visiera) conforme alla norma EN140:1998

Maschere Integra (con visiera) conforme alla norma EN166 2.F.K.N.

Filtri conformi alla norma EN 143:2000/A1P3 (RD) PER P3

Filtri conformi alla norma EN14387 PER A1P3 Gas E POLVERI. Maschere Integra e filtri sono certificati CE.

FILTRO ELIPSE A1-P3 COPPIA RICAMBIO



PRO

Articolo	€ Listino	
3087000	23,04	4

• Filtri plissettati intercambiabili, con efficienza minima del 99,97% ed una porosità 0,3 micron.

CARATTERISTICHE FILTRI

A1	Filtri per gas e vapori organici con punto di ebollizione >65 °C
A2B2E2K2	Filtro antigas per gas e vapori organici con punto di ebollizione superiore a 65°C, gas e vapori inorganici, gas acidi, Anidride Solforosa(SO ₂), Ammoniaca (NH ₃) e suoi derivati.
A2B2E2K2P3 R	Filtro combinato per gas e vapori organici con punto di ebollizione superiore a 65°C, gas e vapori inorganici, gas acidi, Anidride Solforosa (SO ₂), Ammoniaca (NH ₃) e suoi derivati, polveri, fumi e nebbie.
A1B1E1K1	Filtri combinati per gas e vapori organici con punto di ebollizione superiore a 65°C, gas e vapori inorganici, gas acidi, Anidride Solforosa (SO ₂), Ammoniaca (NH ₃) e suoi derivati
A1P2 R	Filtri combinati per gas e vapori organici con punto di ebollizione superiore a 65°C , polveri, fumi e nebbie.
P2	Filtri per polveri, fumi e nebbie. (NR = utilizzabili per un solo turno di lavoro) Composti dall'accoppiamento degli degli articoli: 2002 + COP2002 + BAR2002

GANCIO PER MASCHERA INTEGRA A1P3



Articolo	€ Listino	
3087030A	1,80	10

• Per maschera 3089005

Per informazioni tecniche, foto e prezzi aggiornati visita il nostro sito www.cillisrl.com



**SET 50 MASCHERINE 160 g
PER POLVERI**

Articolo	Tipo	€ Listino	
3081110	In box	5,00	100



**SET 10 MASCHERINE
PER POLVERI**

Articolo	Tipo	€ Listino	
3081150	In blister	1,50	100



**MASCHERINA VAPORI ORGANICI CE
EN 149 FFP1 CON VALVOLINA**

Articolo	Tipo	€ Listino	
3081261	In box	1,50	100

• EN 149 FFP1 Facciali filtranti monouso contro le particelle solide grossolane senza tossicità specifica come: Polveri e nebbie a base acquosa e oleosa di materiale particellare con granulometria >0,02 micron contenenti: carbonato di calcio, lana di vetro, caolino, cemento, cellulosa, zolfo, cotone, farine, carbone, metalli ferrosi, oli vegetali e minerali..



**MASCHERINA CON VALVOLINA CE
EN 149 FFP2 PER VAPORI ORGANICI**

Articolo	Tipo	€ Listino	
3081251	In busta	1,64	100

• EN 149 FFP2 Facciali filtranti monouso contro gli aerosol solidi e/o liquidi indicati come pericolosi o irritanti: Polveri, nebbie e fumi a base acquosa e oleosa di materiale particellare con granulometria >0,02 micron contenenti: cellulosa, carbonato di calcio, silconato di sodio, pietra da gesso, grafite, zolfo, cotone, fibre di vetro e di plastica, carbone, oli vegetali e minerali, silice, rame, alluminio, cromo, bario, titanio, vanadio, quarzo, manganese, molibdeno.

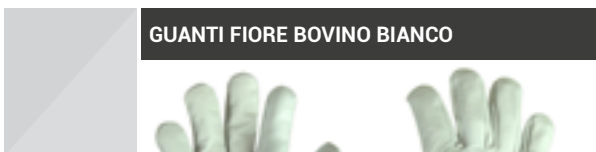

GUANTI FIORE BOVINO BIANCO

Articolo	Tg	€ Listino	
3080285	8	4,20	60
3080290	9	4,20	60
3080294	10	4,20	60



GUANTI FIORE PIENO GIROPOLLICE

Articolo	Tg	€ Listino	
3080312	10	4,80	60



GUANTI BOVINO DORSO CROSTA

Articolo	Tg	€ Listino	
3080332	9	3,90	60
3080333	10	3,90	60

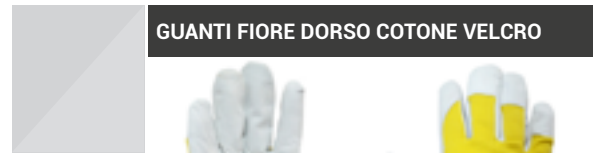

GUANTI FIORE DORSO COTONE VELCRO

Articolo	Tg	€ Listino	
3080279	8 Giallo	5,48	60
3080280	10 Rosso	5,48	60

GUANTI FIORE DORSO COTONE TOP



Articolo	Tg	€ Listino	
3080328	8	2,90	60
3080329	9	2,90	60
3080330	10	2,90	60

GUANTI PELLE MAIALE DORSO TELA



Articolo	Tg	€ Listino	
3080360	10	2,90	60

GUANTI NBR DORSO CHIUSO MANICHETTA



Articolo	Tg	€ Listino	
3080900	10	2,30	60

GUANTI NBR DORSO AERATO MANICHETTA



Articolo	Tg	€ Listino	
3080888	10	2,40	60

GUANTI GIALLI PESANTE



Articolo	Tg	€ Listino	
3080953	8	1,30	60



Per informazioni tecniche, foto e prezzi aggiornati visita il nostro sito www.cillisrl.com

GUANTI NITRILE GRIGIO



Articolo	Tg	€ Listino	
3080506	6	0,94	60
3080507	7	0,94	60
3080508	8	0,94	60
3080509	9	0,94	60
3080511	10	0,94	60
3080510	11	0,94	60

GUANTI NITRILE FOAM NERO



Articolo	Tg	€ Listino	
3080515	10	3,04	60

GUANTI NITRILE GRIGIO CON FONDO GRIGIO FILO CONTINUO



Articolo	Tg	€ Listino	
3080603	8	1,00	60
3080604	9	1,00	60
3080605	10	1,00	60
3080606	11	1,00	60

GUANTI NYLON NITRILE



Articolo	Tg	€ Listino	
3080518	8 Nero/Rosso	1,66	60

GUANTI POLIURETANO NERI



Articolo	Tg	€ Listino	
3080476	8	1,30	60
3080477	9	1,30	60
3080478	10	1,30	60
3080479	11	1,30	60

**GUANTI NYLON POLIURETANO
EXTRA FLESSIBILI BIANCHI**



Articolo	Tg	€ Listino	
3080480	7	1,10	60
3080481	8	1,10	60
3080482	9	1,10	60
3080483	10	1,10	60
3080484	11	1,10	60

**GUANTI NYLON
POLIURETANO GRIGI**



Articolo	Tg	€ Listino	
3080420	7	1,30	60
3080421	8	1,30	60
3080422	9	1,30	60
3080423	10	1,30	60
3080424	11	1,30	60

GUANTI ALTA VISIBILITA' LATTICE



SUPER GRIP

Articolo	Tg	€ Listino	
3080434	9	2,88	72
3080435	10	2,88	72

GUANTI NYLON POLIURETANO BLU



Articolo	Tg	€ Listino	
3080485	L	0,84	50
3080486	XL	0,84	50

GUANTI NITRILE PUNTINATO



SUPER GRIP

Articolo	Tg	€ Listino	
3080909	9	3,54	72
3080910	10	3,54	72
3080911	11	3,54	72

GUANTI NEOPRENE



Articolo	Tg	€ Listino	
3080743	M	3,22	60
3080745	L	3,22	60
3080748	XL	3,22	60

GUANTI UNIVERSALI BICOLOR



Articolo	Tg	€ Listino	
3080702	S Verde/Giallo	1,80	60
3080704	M Blu/Giallo	1,80	60
3080705	L Blu/Giallo	1,80	60
3080708	XL Blu/Giallo	1,80	60

**GUANTI IN LATTICE
BOX 100 PZ MONOUSO**

• Ambidestri; No sterili; Mono uso; In lattice; Con talco.



Articolo	Tg	€ Listino	
3080545	S	5,20	10
3080550	M	5,20	10
3080555	L	5,20	10

Per informazioni tecniche, foto e prezzi aggiornati visita il nostro sito www.cillisrl.com

GUANTI NITRILE BLU SENZA TALCO BOX 100 PZ MONOUSO

- Ambidestri; No sterili; Mono uso; Senza lattice; Senza talco.



Articolo	Tg	€ Listino	
3080502	S	5,90	10
3080503	M	5,90	10
3080504	L	5,90	10
3080505	XL	5,90	10

CONFEZIONE 100 PZ GUANTI LATTICE CON ALOE VERA

- Senza polvere
- Lasciano la pelle morbida
- Con fori superiore



Articolo	Tg	€ Listino	
3080440	S	9,64	12
3080443	M	9,64	12
3080446	L	9,64	12

TUTA IN PROPYLENE BIANCA

Articolo	Tg	€ Listino	
3148135	L	2,00	50
3148140	XL	2,00	50
3148145	XXL	2,00	50

TUTA IN PROPYLENE BLU

Articolo	Tg	€ Listino	
3148148	L	2,28	50
3148150	XL	2,28	50
3148155	XXL	2,28	50

TUTA PRO-KEM BIANCA

Articolo	Tg	€ Listino	
3148110	L	6,96	50
3148115	XL	6,96	50
3148120	XXL	6,96	50

TUTA JETGUARD CON CAPPUCCIO 3A CAT. CE TIPO 3, 4, 5 E 6

- Protezione nucleare (EN 1073-2)
- Indumenti non ventilati
- Protezione biologica (EN 14126)
- Protezione chimica (EN 14605 tipo 3)
- (EN ISO 13982-1 tipo 5) (EN 13034 tipo 6)
- Proprietà antistatiche (EN 1149)

Articolo	Tg	€ Listino	
3147500	L	21,00	5
3147505	XL	21,00	5
3147510	XXL	21,00	5



TUTA PROPYLENE
BIANCA

TUTA PROPYLENE
BLU

TUTA PROKEM
BIANCA

CARATTERISTICHE TUTA PROKEM

Protezione dagli agenti chimici e nello specifico:

EN ISO 13982-1:2004+A1:2010

Tipo 5 - Protezione contro particelle solide disperse nell'aria.

EN 13034:2005-A1:2009

Tipo 6 - Protezione limitata contro gli agenti chimici liquidi (spruzzi)

EN 14126:2003+AC:2004

Tipo 5-B e 6-B- Protezione contro gli agenti infettivi.

EN 1149-5:2008

Indumenti dotati di caratteristiche antistatiche per dissipare cariche elettrostatiche.

EN 1073-2:2002

Protezione contro contaminazione radioattiva sotto forma di particelle.



TUTA LIFE GUARD MASTER I TIPO 4-5B-6B

UNI EN 14605: Tipo 4
 UNI EN
 ISO 13982-1: tipo 5 B
 UNI EN 13034: tipo 6B
 UNI EN 14126: Classe 5
 UNI EN 14126: Classe 6
 UNI EN 14126: Classe 3
 UNI EN 1073-2: Classe 1

Articolo	Tg	€ Listino	
3147350	L	10,06	50
3147355	XL	10,06	50
3147360	XXL	10,06	50



**TUTA LIFE GUARD PLUS 5B 6B
 BIANCA CON POLSINI IN MAGLINA**



Articolo	Tg	€ Listino	
3147300	L	5,48	50
3147305	XL	5,48	50
3147310	XXL	5,48	50

Tuta protettiva in non tessuto laminato.
 Protezione chimica EN 13034/05 Tipo 6B; EN ISO 13982-1/04 Tipo 5B
 Antistaticità EN 1149-5/08
 Particelle radioattive EN 1073-2
 Rischio biologico EN 14126
 Cappuccio con elastico; Giro manica ampio per garantire la massima visibilità e confort; Polsini in maglina; Rilascio di particelle nullo; Bordo elastico alle caviglie; Assenza di silicone.



**TUTA BODY GUARD 5B 6B
 BIANCA**



Articolo	Tg	€ Listino	
3147400	L	4,52	50
3147405	XL	4,52	50
3147410	XXL	4,52	50

Tuta protettiva in non tessuto laminato.
 Protezione chimica EN 13034/05 Tipo 6B; EN ISO 13982-1/04 Tipo 5B
 Antistaticità EN 1149-5/08
 Particelle radioattive EN 1073-2
 Rischio biologico EN 14126
 Cappuccio con elastico; Giro manica ampio per garantire la massima visibilità e confort; Polsini in maglina; Rilascio di particelle nullo; Bordo elastico alle caviglie; Assenza di silicone.

**COMPLETO POLIAMIDE
 GIUBBA CON CAPPUCCIO+PANTALONE**



Articolo	Tg	€ Listino	
3140420	L	13,10	25
3140430	XL	13,10	25
3140440	XXL	13,10	25

**COMPLETO ANTISTRAPPO
GIUBBA CON CAPPUCCIO+PANTALONE**



Articolo	Tg	€ Listino	
3140020	L	10,60	20
3140030	XL	10,60	20
3140040	XXL	10,60	20
3140050	XXXL	10,60	20

GAMBALI POL/PVC VERDE



Articolo	Tg	€ Listino	
3140350	L	7,00	25
3140360	XXL	7,00	25

STIVALE GINOCCHIO PVC CARRARMATO



Articolo	€ Listino	
31290..	11,18	10

• Calzature disponibili: 40-41-42-43-44-45-46-47
Aggiungere numero calzatura alla fine del codice

STIVALE TRONCHETTO PVC CARRARMATO



Articolo	€ Listino	
31280..	11,00	10

• Calzature disponibili: 40-41-42-43-44-45-46
Aggiungere numero calzatura alla fine del codice

STIVALE GINOCCHIO GOMMA CALANDRATO

SEKON



Articolo	€ Listino	
31320..	17,00	6

• Calzature disponibili: 40-41-42
Aggiungere numero calzatura alla fine del codice

STIVALE VIRGINIA 04 IN POLIURETANO

LEVER



Robusto e leggero
Calzata 12
Isolamento termico -20°C
Fodera interna OEKO-TEX
Sanitized.
Flessibile, Shock
Absorber, Antiscivolo

**NORMATIVA UNI EN ISO
20347:2012**

Articolo	Taglia	€ Listino	
3135041	41	54,40	3
3135042	42	54,40	3
3135043	43	54,40	3
3135044	44	54,40	3

**SCARPA SCAMOSCIATA BASSA S1P
LAMINA + PUNTA SRC**

LEWER



Articolo	€ Listino	
31374..	34,00	5

• Calzature disponibili: 40-41-42-43-44-45

Aggiungere numero calzatura alla fine del codice

Tomaia: Pelle scamosciata forata ; FODERA: AIR PLUS ad alto grado di evaporazione e resistenza all'abrasione; Soletta: Estraibile e termoformata ad alto potere di assorbimento del sudore ; Punta: Acciaio 200J ; Antiperforazione: Acciaio INOX

**SCARPA ANTINFORTUNISTICA BASSA S1P
LAMINA + PUNTA SRC**

LEWER



Articolo	€ Listino	
31370..	34,00	5

• Calzature disponibili: 40-41-42-43-44-45

Aggiungere numero calzatura alla fine del codice

Tomaia: Crosta stampata dollaro ; FODERA: AIR PLUS ad alto grado di evaporazione e resistenza all'abrasione ; Soletta: Estraibile e termoformata ad alto potere di assorbimento del sudore ; Punta: Acciaio 200J ; Antiperforazione: Acciaio INOX

**SCARPA ANTINFORTUNISTICA ALTA S1P
LAMINA + PUNTA SRC**

LEWER



Articolo	€ Listino	
31373..	34,00	5

• Calzature disponibili: 39-40-41-42-43-44-45-46

Aggiungere numero calzatura alla fine del codice

Tomaia: Crosta stampata dollaro ; FODERA: AIR PLUS ad alto grado di evaporazione e resistenza all'abrasione; Soletta: Estraibile e termoformata ad alto potere di assorbimento del sudore ; Punta: Acciaio 200J ; Antiperforazione: Acciaio INOX

SCARPA TREKKING ALTA S1P

LEWER



Articolo	€ Listino	
31371..	51,68	5

• Calzature disponibili: 40-41-42-43-44-45

Aggiungere numero calzatura alla fine del codice

Tomaia: Pelle scamosciata, inserti in tessuto alta resistenza allo strappo ; FODERA: AIR PLUS ad alto grado di evaporazione e resistenza all'abrasione; Soletta: Estraibile e termoformata ad alto potere di assorbimento del sudore ; Punta: Acciaio 200J ; Antiperforazione: Acciaio INOX

**SCARPA ALTA S3
LAMINA + PUNTALE IN COMPOSITO SRC**

LEWER



Articolo	€ Listino	
31376..	63,38	5

• Calzature disponibili: 40-41-42-43-44-45

Aggiungere numero calzatura alla fine del codice

Tomaia: Pelle fiore ingrassata, idrorepellente ; FODERA: AIR PLUS ad alto grado di evaporazione e resistenza all'abrasione ; Soletta: Estraibile e termoformata ad alto potere di assorbimento del sudore ; Punta: Composito 200J ; Antiperforazione: HTC Insole perforazione zero



FERRAMENTA





BRUCIATORE CON LEVA A NORME



Articolo	Ømm	Lcm	€ Listino	
9998020	25-35-50	38/41	19,00	6
9998050	35	40	13,20	6
9998080	60	60	17,00	6
9998090	60	70	17,40	6



CANNELLO SALDATURA CON MAZZA RAME A NORME



Articolo	Lmm	€ Listino	
9998010	31	23,86	6



BRUCIATORE ACCENSIONE PIEZO A NORME



Articolo	Ømm	Lcm	€ Listino	
9998100	60	70	25,68	6



SALDATORE A CARTUCCIA CORPO METALLO A NORME EN417



Articolo		€ Listino	
9998905	Piezo	16,20	12
9998910	Senza Piezo	14,70	12

• Montano cartucce universali da 190 grammi, non in dotazione.



LAMPADA A GAS PIEZO

Articolo	€ Listino	
9998865	19,50	12

• Montano cartucce universali da 190 grammi, non in dotazione.



VETRO PER LAMPADA



Articolo	€ Listino	
9998995	5,00	12



SET 3 RETINE DI RICAMBIO



Articolo	Watt	€ Listino	
9998990	300-400	1,20	100
9998992	500-600	1,26	100



Per informazioni tecniche, foto e prezzi aggiornati visita il nostro sito www.cillisrl.com

CASSETTA DI SICUREZZA VALORI



Articolo	Lcm	kg	€ Listino	
9826300	20x16x9	0,920	13,50	6

CASSETTA PORTALETTERE GHISA AD INCASSO E A PARETE



Articolo	Lcm	kg	€ Listino	
8610350	27x40	12,000	35,00	1

SET BLOCCA CAVI 130 PEZZI



Articolo	Lmm	€ Listino	
9824301	4	1,30	72

PINZA SUPER PRENDITUTTO PROFESSIONALE



Articolo	Lcm	€ Listino	
9880003	90	13,40	6

• Ventose removibili; maxi presa; impugnatura ergonomica e girevole; blocco presa

PINZA UNIVERSALE ALLUMINIO



Articolo	Lcm	€ Listino	
9880000	75	7,00	24

SET PULIZIA



Articolo	€ Listino	
9215223	2,50	48

SPAZZOLA LAVAGGIO AUTO



Articolo	€ Listino	
9215115	7,80	6

SPUGNA LAVAGGIO AUTO



Articolo	€ Listino	
9982008	1,40	36

CRIC A CARRELLO IN BOX BMC



Articolo	Portata	Alzata mm	€ Listino	
9884225	2 ton	135-300	60,00	6

CRIC A BOTTIGLIA



Articolo	Portata	Alzata mm	€ Listino	
9884200	2 ton	150-160	15,00	12
9884205	5 ton	205-296	25,00	10
9884218	20 ton	240-400	61,00	2

* Cric a bottiglia 2 tonnellate completo di struttura a croce, vite di comando per adattare l'altezza e valvola di rilascio per il controllo di abbassamento e innalzamento del cric.

CORDA TRAINO NYLON 2 GANCI



Articolo	Lcm	€ Listino	
9884418	130	6,50	12

LAMPADA PORTATILE AL NEON CON CAVO 220V



Articolo	Lcm	€ Listino	
9881228	485	5,00	12

CAVI BATTERIA AUTO



Articolo	Amp	Lunghezza	€ Listino	
9884120	120	245 cm	4,20	20
9884122	200	250 cm	6,00	24
9884124	600	246 cm	12,90	10

SPAZZOLA PULIZIA POLI BATTERIA AUTO



Articolo	€ Listino	
9981057	1,60	12

TANICA IN METALLO DI SICUREZZA A NORMA

• Taniche di sicurezza certificate UN, per carburanti, qualità superiore, produzione Europea. Verniciate e zincate anche all'interno



PRO

Articolo	Lt	€ Listino	
9914035	5	24,30	5
9914040	10	28,06	5
9914045	20	33,00	5
9914048	Guarnizione	1,90	50

TANICA IN PLASTICA CON BLOCCAGGIO

• Taniche di sicurezza certificate UN, per carburanti.



PRO

Articolo	Lt	€ Listino	
9914060	5	5,26	30
9914065	10	7,20	20
9914070	20	11,70	10

BOCCAGLIO PER TANICHE DI SICUREZZA



PRO



Articolo	€ Listino	
9914050	12,69	20

• Adatto agli articoli: 9914035- 9914040 - 9914045

IMBUTO IN PLASTICA CON FILTRO



Articolo	Lmm	€ Listino	
9884020	460	1,50	72

SERIE IMBUTI PLASTICA



Articolo	Lmm	€ Listino	
9884024	50-75-100-125	1,70	72

PISTOLA GASOLIO



Articolo	Ø Raccordo	€ Listino	
6002200	19	15,20	6
6002210	25	16,20	6

PISTOLA BIANCA



Articolo	Ø Raccordo	€ Listino	
6002180	19	15,20	6

PISTOLA ALLUMINIO



Articolo	Ø	€ Listino	
6002105	20	33,00	3

Raccordo femmina da 1"

KIT TRAVASO GASOLIO 220 V

Articolo	Ø	€ Listino	
6002020	20	230,00	1

• Tubo aspirazione 1,80 mt. Tubo pistola 4 mt



CONTALITRI ATTACCO 1"



Articolo	€ Listino	
6002150	62,70	3

POMPA ATTACCO TRAPANO PER LIQUIDI



Articolo	Attacco	€ Listino	
6000015	1/2"	14,56	10

- Capacità totale: 2500 litri/ora
- Pescaggio profondità 2,5 m
- Altezza portata 10 m
- Funzionamento a secco 30"
- Attacco per tubi da 1/2"
- Gambo diametro 8 mm

TRAVASO CARBURANTE IN KIT



Articolo	€ Listino	
0031000	9,60	30

POMPA TRAVASO FUSTI ROTANTE



Articolo	Ø	Lcm	€ Listino	
6902020	25 mm	100	35,00	10
6902010	32 mm	100	40,00	10



Per informazioni tecniche, foto e prezzi aggiornati visita il nostro sito www.cillisrl.com

BURG
WWW.BURG.TOOLS

POMPA TRAVASO OLIO PROFESSIONALE



Articolo	Ø	€ Listino	
6902040	20 mm	28,00	10

POMPA A BARILE PER OLIO



Articolo	Lt	€ Listino	
6901012	16	77,00	4

POMPA A BARILE PER GRASSO



Articolo	Lt	€ Listino	
6901016	16	89,00	4

INGRASSATORE A COMPRESSIONE COMPLETO PER GRASSO SFUSO



Articolo	Kg	€ Listino	
6900710	0,400	10,00	10

• Non adatto alla cartuccia

BURG
WWW.BURG.TOOLS

INGRASSATORE A COMPRESSIONE GERMANY CON PROLUNGA FLESSIBILE



Articolo	Kg	€ Listino	
6900720	0,500	15,30	48

BURG
WWW.BURG.TOOLS

TUBO PER INGRASSATORE



Articolo	€ Listino	
6900700	2,00	50

INGRASSATORE CON TESTINA



Articolo	€ Listino	
9981058	2,00	48

TESTINA 4 GRIFFES HIDRAULIC



Articolo	Tipo	€ Listino	
6900600	10x1	1,30	60



TESTINA 3 GRIFFES HIDRAULIC



Articolo	Tipo	€ Listino	
6900630	10x1	1,00	60

TESTINA INGRASSAGGIO COUPLER 10X1 LONG

Articolo	€ Listino	
9740042	36,80	1

TESTINA XL PER POMPE INGRASSAGGIO



Articolo	€ Listino	
9740040	44,20	3

Filetto M10x1. Lunghezza 88 mm. Grilletto per aggancio/sgancio può essere azionato facilmente con una sola mano.

Caratteristiche:

4 ganasce indurite estremamente resistenti all'usura. Guarnizione ad alte prestazioni per una lunga durata, valvola di non ritorno per una tenuta estrema senza perdita di grasso.

PISTOLA NAFTA AD ARIA COMPRESSA



Articolo		€ Listino	
9729150	1,000	12,00	5

cilli

PISTOLA INGRASSATORE ARIA



Articolo	€ Listino	
6903000	30,00	6

• Ingrassatore ad aria compressa, utilizzabile sia con grasso sfuso che con cartucce da 400cc e 500cc del diametro di 53mm.



POMPA ESTRAZIONE OLIO MOTORE 5,5 LT



Articolo	€ Listino	
9740045	112,88	2

• Completa di tubi per aspirazione

OLIATORE A CANNA FLESSIBILE



Articolo		€ Listino	
9862500	0,300	3,00	60
9862510	0,500	4,50	60

POMPA MANUALE PER BICI



Articolo	€ Listino	
9885021	7,00	12

POMPA BURG PROFESSIONALE PER BICI CON MANOMETRO



Articolo	€ Listino	
9885030	15,00	12

POMPA PEDALE CON MANOMETRO 1 PISTONE



Articolo	€ Listino	
9885001	7,20	24

MANOMETRO PROVA PRESSIONE



Articolo	€ Listino	
9884450	0,71	50

COMPRESSORE COASSIALE AUTOLUBRIFICATO 25L



Articolo	€ Listino	
9721300	158,00	1

CARATTERISTICHE

Litri serbatoio	25
Potenza	2,0 Hp
Alimentazione	220 Voltr
Dimensioni	53 x 33 x 57 cm
Peso	26 Kg
Lunghezza cavo alimentazione	180 cm

PISTOLA GONFIAGGIO CON MANOMETRO



Articolo	€ Listino	
9729135	14,00	6

PISTOLA SOFFIAGGIO ARIA INNESTO ITALIANO



Articolo	€ Listino	
9729140	4,60	12

• Con tre diversi raccordi in dotazione

**TUBO A SPIRALE
PER ARIA CON RACCORDI**



Articolo	Lmt	€ Listino	
9729710	5	6,20	40
9729715	15	11,02	40

KIT GONFIAGGIO ABAC

ABAC



Articolo	€ Listino	
9721332	28,00	1

**KIT 5 PZ ACCESSORI
COMPRESSORE**

ABAC

- Kit 5 accessori per compressore ed aria compressa Abac composto da:
- 1 Pistola lavaggio nebulizzatore
- 1 Pistola gonfiaggio

- 1 Pistola soffiaggio
- 1 Aerografo per verniciatura con serbatoio 1 litro
- 1 Tubo a spirale 8 bar - 5 ml (metri lineari)



Articolo	€ Listino	
9721280	39,44	3

**PISTOLA PER VERNICIATURA
PNEUMATICA**

ABAC



Articolo	€ Listino	
9721296	27,20	3

PRESSOSTATO 4 VIE 1/4 F

ABAC



Articolo	€ Listino	
9721298	30,00	3

**TRAPANO PNEUMATICO
REVERDIBILE 10MM**

ABAC



Articolo	€ Listino	
9721286	68,00	2

AVVITATORE A CRICCHETTO 1/2" ABAC

ABAC



Articolo	€ Listino	
9721284	54,40	2

- Avvitatore a cricchetto ad aria compressa.

Per informazioni tecniche, foto e prezzi aggiornati visita il nostro sito www.cillisrl.com



AVVITATORE AD IMPULSI 1/2 B-LINE

Articolo	€ Listino	
9721283	81,60	2

• Avvitatore ad impulsi ad aria compressa.



GRAFFATRICE CHIODATRICE BLS

Articolo	€ Listino	
9721294	108,80	2

• Graffatrice a cricchetto ad aria compressa.



KIT UTENSILI PNEUMATICI 34 PZ ABAC

Articolo	€ Listino	
9721282	150,00	1

• Kit 34 utensili in valigetta.



MARTELLO CON 4 SCALPELLI BLS

Articolo	€ Listino	
9721287	46,24	2

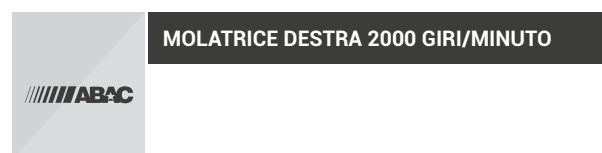

MOLATRICE DESTRA 2000 GIRI/MINUTO

Articolo	€ Listino	
9721293	40,80	2



ABAC

COMPRESSORE 6 LITRI -1,5HP ABAC



Articolo	€ Listino	
9721292	146,80	1

CARATTERISTICHE

Litri serbatoio	6
Litri al minuto	160
Potenza	1,5 Hp
Motore	1,1 kW
Giri al minuto	2450
Alimentazione	230/1/50 Volt
Pressione d'esercizio	8 bar
Dimensioni	53 x 21 x 54 cm
Peso	11 Kg

ABAC

COMPRESSORE B20 ABAC GIALLO 24L



Articolo	€ Listino	
9721305	171,00	1

CARATTERISTICHE

Litri serbatoio	24
Litri al minuto	190
Potenza	2 Hp
Motore	1,5 kW
Giri al minuto	2850
Alimentazione	230 Volt 50 Hz
Pressione d'esercizio	8 bar
Dimensioni	61 x 31 x 58 cm
Peso	24 Kg

ABAC

COMPRESSORE B20 ABAC GIALLO 50L



Articolo	€ Listino	
9721314	217,00	1

CARATTERISTICHE

Litri serbatoio	50
Litri al minuto	190
Potenza	2 Hp
Motore	1,5 kW
Giri al minuto	2850
Alimentazione	230 Volt 50 Hz
Pressione d'esercizio	8 bar
Dimensioni	77 x 43 x 66 cm
Peso	32 Kg

ABAC

COMPRESSORE ABAC 90L



Articolo	€ Listino	
9721316	598,00	1

CARATTERISTICHE

Litri serbatoio	90
Litri al minuto	240
Potenza	2 Hp
Motore	1,5 kW
Giri al minuto	1600
Alimentazione	230 Volt 50 Hz
Pressione d'esercizio	10 bar
Dimensioni	110 x 40 x 83 cm
Peso	64 Kg

Per informazioni tecniche, foto e prezzi aggiornati visita il nostro sito www.cillisrl.com

COMPRESSORE A MURO XPN 015 ABAC



Articolo	€ Listino	
9721330	319,20	1

CARATTERISTICHE	
Litri serbatoio	0
Litri al minuto	160
Potenza	1,5 Hp
Motore	1,1 kW
Giri al minuto	2450
Alimentazione	230/1/50 Volt
Pressione d'esercizio	8 bar
dB(A)	68
Dimensioni	28 x 38,5 x 49,5 cm
Peso	8,5 Kg
Tube incluso	10 mt

MINICOMPRESSORE COMPY 015 ABAC



Articolo	€ Listino	
9721285	122,40	1

CARATTERISTICHE	
Litri serbatoio	0
Litri al minuto	180
Potenza	1,5 Hp
Motore	1,1 kW
Giri al minuto	2450
Alimentazione	230/1/50 Volt
Pressione d'esercizio	8 bar
dB(A)	90
Dimensioni	38 x 28 x 17 cm
Peso	4 Kg

START 015 MINICOMPRESSORE ABAC



Articolo	€ Listino	
9721288	163,20	1

CARATTERISTICHE	
Litri serbatoio	6
Litri al minuto	180
CFM	6,3
Potenza	1,5 Hp
Motore	1,1 kW
Giri al minuto	3400
Alimentazione	230/1/50 Volt
Pressione d'esercizio	8 bar
dB(A)	97
Dimensioni	33 x 36 x 35 cm
Peso	9,5 Kg

COMPRESSORE 6 LITRI ABAC



Articolo	€ Listino	
9721299	144,16	1

CARATTERISTICHE	
Litri serbatoio	6
Litri al minuto	180
Potenza	1,5 Hp
Motore	1,1 kW
Giri al minuto	2450
Alimentazione	230/1/50 Volt
Pressione d'esercizio	8 bar
dB(A)	90
Dimensioni	32 x 37 x 29 cm
Peso	10 Kg

COMPRESSORE 24 LITRI ABAC

ABAC



Articolo	€ Listino	
9721312	221,20	1

CARATTERISTICHE

Litri serbatoio	24
Litri al minuto	220
Potenza	2 Hp
Motore	1,5 kW
Giri al minuto	2850
Alimentazione	230/1/50 Volt
Pressione d'esercizio	10 bar
dB(A)	90
Dimensioni	60 x 32,5 x 60,5 cm
Peso	25 Kg

COMPRESSORE 50 LITRI ABAC

ABAC



Articolo	€ Listino	
9721313	224,00	1

CARATTERISTICHE

Litri serbatoio	50
Litri al minuto	222
Potenza	2,0 Hp
Motore	1,5 kW
Giri al minuto	2850
Alimentazione	230/1/50 Volt
Pressione d'esercizio	8 bar
dB(A)	94
Dimensioni	77 x 31 x 64,5 cm
Peso	32,6 Kg

COMPRESSORE 100 LITRI ABAC

ABAC



Articolo	€ Listino	
9721315	714,00	1

CARATTERISTICHE

Litri serbatoio	100
Litri al minuto	255
Potenza	2,0 Hp
Motore	1,5 kW
Giri al minuto	1075
Alimentazione	230/1/50 Volt
Pressione d'esercizio	10 bar
dB(A)	94
Dimensioni	101 x 41,5 x 90 cm
Peso	56 Kg

PORTA FILTRO PROF 10"
ATTACCO 1"



PRO

Articolo	Lmm	€ Listino	
9218355	311x122x118	26,00	24

• Chiave e staffe incluse.

I sistemi filtranti sono stati progettati per eliminare dall'acqua tutti quei problemi derivanti dalla presenza nell'acqua di particelle in sospensione quali sabbia ruggine, sapori, e odori sgradevoli, cloro e particelle solide, nelle applicazioni residenziali e commerciali.

PORTA FILTRO PROF 5"
ATTACCO 3/4"



PRO

Articolo	Lmm	€ Listino	
9218305	191x122x118	23,00	24

• Chiave e staffe incluse.

I sistemi filtranti sono stati progettati per eliminare dall'acqua tutti quei problemi derivanti dalla presenza nell'acqua di particelle in sospensione quali sabbia ruggine, sapori, e odori sgradevoli, cloro e particelle solide, nelle applicazioni residenziali e commerciali.

Per informazioni tecniche, foto e prezzi aggiornati visita il nostro sito www.cillisrl.com

CARTUCCIA FILTRO PROF 5"



PRO

Articolo	Lmm	Tipo	€ Listino	
9218310	125x70	Rete	3,80	100
9218315	120x65	Filo	2,00	100

CARTUCCIA FILTRO PROF 10"



PRO

Articolo	Lmm	Tipo	€ Listino	
9218360	250x70	Rete	6,50	60
9218365	255x65	Filo	3,00	50
9218366	255x65	Filo	2,90	60
9218370	250x70	Carbone	6,00	48

CARTUCCIA IN RETE: Idonee all'uso in sistemi filtrazione e rimozione di sedimenti, sabbia, particelle solide in sospensione, protezione pompe per agricoltura, prefiltrazione in sistemi di trattamento industriali, prefiltrazione in sistemi di irrigazione.

CARTUCCIA IN FILO: Idonee all'uso in sistemi filtrazione e rimozione di sedimenti, sabbia, particelle solide in sospensione, protezione pompe per agricoltura, prefiltrazione in sistemi di trattamento industriali, prefiltrazione in sistemi di irrigazione.

CARTUCCIA IN CARBONE: Struttura combinata di fibre sintetiche, cellulose e carbone attivo. Grado di filtrazione nominale 5µm. Sistema di filtrazione e rimozione impurità, cloro e contaminanti al punto d'uso, acque ad uso industriale acque di processo.

DOCCETTA LUX CON SALISCENDI COMPLETO



Articolo	€ Listino	
1949140	25,00	10

• Lunghezza asta 600mm

DOCCETTA EXTRA CON SALISCENDI COMPLETO



Articolo	€ Listino	
1949130	17,00	10

• Lunghezza asta 520mm

DOCCETTA EXTRA



Articolo	€ Listino	
1949105	7,00	12

DOCCETTA LUX



Articolo	€ Listino	
1949110	7,20	12

FLESSIBILE F1/2 X FI/2



Articolo	Lcm	€ Listino	
1949120	150	3,00	48

PORTAROTOLO A PARETE VERNICIATO

BURG
www.burg.tools



Articolo	Lcm	€ Listino	
9798240	38x32x22,5	15,00	10

• Rotolo carta non compreso

PORTAROTOLO A TERRA VERNICIATO



Articolo	Lcm	€ Listino	
9798250	43x86x49	15,00	6

DISPENCER SAPONE SINGOLO



Articolo	€ Listino	
2010010	8,00	40

DISPENCER SAPONE DOPPIO



Articolo	€ Listino	
2010020	11,00	40

CREMA LAVAMANI BIANCA SATURNO CON MICROGRANULI



Articolo	Lt	€ Listino	
9797100	1	3,40	12
9797110	4	12,30	4

CREMA SATURNO FLUIDA CON DOSATORE



Articolo	Lt	€ Listino	
9797150	3	15,70	6

BOTTIGLIA SATURNO CON DOSATORE



Articolo	Lt	€ Listino	
9797170	1	2,88	12

GEL LAVAMANI SATURNO CON DOSATORE



Articolo	Lt	€ Listino	
9798130	5	20,60	4

TANICA OKTIMA FLUIDA CON DOSATORE



Articolo	Lt	€ Listino	
9797190	3	18,00	6
9797210	Ricarica 3 lt	12,00	6

SUPER POMPA STURATUBI E LAVANDINI



Articolo	€ Listino	
9862820	5,00	24

STURATUBI IN GOMMA



Articolo	€ Listino	
9862845	2,70	60

MOLLA STURATUBI E LAVANDINI SPESSORE 5.5mm



Articolo	Lmt	€ Listino	
9862835	3	3,20	48

DISGORGANTE RAPIDO SGORG



Articolo	MI	€ Listino	
9862860	750	4,64	24

IL SUPER DISGORGANTE PROFESSIONALE AD ALTISSIMA EFFICENZA Libera immediatamente tubazioni, lavandini e scarichi dalle occlusioni. Speciale formula protegge tubi. Ad alta concentrazione di acido solforico con inibitori di corrosione che impediscono di rovinare: plastiche, gomme, ferro, pvc, guarnizioni.

SGRASSANTE 1000 USI



Articolo	MI	€ Listino	
9862856	1000	5,90	12

• Pulitore sgrassante universale per qualsiasi intervento e su qualsiasi superficie. Non intacca l'alluminio, altri metalli e plastica se diluito. Diluire dall'1% a 30% in acqua secondo necessità. Applicare e lasciare agire per 30 secondi. Asportare con un panno e risciacquare.

FIRENET CON VAPORIZZATORE



Articolo	MI	€ Listino	
9862880	500	5,30	12

• Pulitore disincrostante per termocamini, vetroceramica, grill, barbecue, forni, ecc. Ottimo per eliminare lo smog dai muri e da altre superfici. Spruzzare a 30 cm dalla superficie da pulire.

SUPER SBLOCCANTE MULTIUSO B4



Articolo	MI	€ Listino	
9798700	400	4,30	12

• Sbloccante idrorepellente, anticorrosivo, lubrificante, detergente e protettivo.

ZINCO PROFESSIONALE SPRAY



Articolo	MI	€ Listino	
9862858	400	5,80	12

• Grazie alle speciali resine contenute si fissa alla superficie creando una protezione di zinco lamellare



**ESPOSITORE 6 PZ WD-40
SISTEMA PROFESSIONALE**

Articolo	MI	€ Listino	
9798715	250+40	186,48	1



ESPOSITORE 6 PZ WD-40 PACK PROMO

Articolo	MI	€ Listino	
9798720	400	46,66	2

• Il prezzo è riferito alla confezione da 6 Bombolette (5+1 in omaggio)



**ESPOSITORE 6 PZ WD-40
SISTEMA PROFESSIONALE**

Articolo	MI	€ Listino	
9798730	500	60,15	2

• Il prezzo è riferito alla confezione da 6 Bombolette (5+1 in omaggio)



BOX WD-40 FLEXIBLE 6 PZ DA 600 ML

Articolo	MI	€ Listino	
9798760	600	90,42	2



Per informazioni tecniche, foto e prezzi aggiornati visita il nostro sito www.cillisrl.com

BURG
WWW.BURG.TOOLS

**FLESSOMETRO BURG 3 STOP
CON CALAMITA ALLA PUNTA**



Articolo	Lmm	€ Listino	
9868502	3 mt x 16 mm	3,00	36
9868503	5 mt x 19 mm	4,00	24
9868505	5 mt x 25 mm	5,00	24
9868507	7,5 mt x 25 mm	5,20	24

BURG
WWW.BURG.TOOLS

FLESSOMETRO CON STOP



Articolo	Lmm	€ Listino	
9868523	3 mt x 16 mm	2,00	24
9868525	5 mt x 19 mm	2,60	24
9868528	7,5 mt x 25 mm	6,30	24
9868529	10 mt x 25 mm	6,50	24

BURG
WWW.BURG.TOOLS

ROTELLA METRICA



Articolo	Lmt	€ Listino	
9868620	20	6,60	12

BURG
WWW.BURG.TOOLS

PORTAMETRO IN CUIO



VERA PELLE

Articolo	Lmt	€ Listino	
9660181	5	5,44	12
9660182	10	6,26	12

LIVELLA 3 BOLLE EXTRA



Articolo	Lmm	€ Listino	
9869040	400	1,50	60

DOPPIO METRO MURATORE IN LEGNO



Articolo	Lcm	€ Listino	
9868002	200	2,00	72

TRACCIALINEE A FILO



Articolo	Lmm	€ Listino	
9864230	300	1,40	30

TORTIGLIA BIANCA SPAGO PER LINEE



Articolo	Lmt	€ Listino	
0690210	100	1,60	15
0690220	200	2,66	24
0690230	500	5,20	12

TORTIGLIA VERDE SPAGO PER LINEE



Articolo	Lmt	€ Listino	
0690250	100	2,30	24
0690260	200	3,30	24

CAZZUOLA PUNTA TONDA CON MANICO IN FIBRA



Articolo	Lmm	€ Listino	
9912180	140	2,00	36

CAZZUOLA PUNTA TONDA CON MANICO IN FIBRA



Articolo	Lmm	€ Listino	
9912170	180	2,40	24

CAZZUOLA PUNTA QUADRA CON MANICO LEGNO



Articolo	Lmm	€ Listino	
9912155	180	2,00	24

FRATTONE PER STUCCATORE



Articolo	Lmm	€ Listino	
9912190	280x120	2,42	24



Per informazioni tecniche, foto e prezzi aggiornati visita il nostro sito www.cillisrl.com

FRATTONI DENTATI



Articolo	Lmm	€ Listino	
9912195	280x120	2,20	24

MISCELATORE PROFESSIONALE



Articolo	Lmm	€ Listino	
9866505	80x8x400	4,00	48
9866509	120x10x600	4,84	48

MISCELATORE PER VERNICI



Articolo	Lmm	€ Listino	
9866480	80x400	2,20	48
9866481	100x600	4,40	50

BETONIERA MINI HOBBY ITC-HS 140C



Articolo	Lt	€ Listino	
9921209	140	380,00	1

CARATTERISTICHE

Modello:	Hobby Mini
Capacità:	140 Litri
Diametro vasca:	24" - 61 cm circa
Ruote:	Antiforatura
Voltaggio:	220V / 240V
Collegamento:	spina industriale 220V
Motore elettrico:	0.5Hp
Velocità motore:	1420rpm
Materiale struttura:	Metallo
Scocca motore:	Plastica

BETONIERA HOBBY



Articolo	Lt	€ Listino	
9921220	180	354,00	1
9921225	140	325,00	1

CARATTERISTICHE 9921220

Capacità	180 lt
Diametro vasca	26"
Ruote	8"x1,75"
Voltaggio	240 V / 50 Hz
Potenza	900 W - 1,2 Hp
Velocità	2800 rpm
Spina	Water proof

CARATTERISTICHE 9921225

Capacità	140 lt
Diametro vasca	26"
Ruote	8"x1,75"
Voltaggio	240 V / 50 Hz
Potenza	550 W - 0,7 Hp
Velocità	2800 rpm
Spina	Water proof



SET 5 PENNELLI ASSORTITI EXTRA



Articolo	€ Listino	
9866010	4,00	48

• Dimensioni pennelli: 1" - 1½" - 2" - 2½" - 3"



PENNELLO MANICO IN PLASTICA CON SETOLE BIO SPESSORE 15mm



PRO

Articolo	Lmm	€ Listino	
9866122	30	0,81	12
9866124	40	0,97	12
9866126	50	1,19	12
9866128	60	1,39	12
9866130	70	1,68	12
9866132	80	2,50	12
9866134	100	3,41	12

• Pennellessa economica ,manico plastica pura setola adatto a lavori generici



PENNELLESA KREX SPESSORE 15mm



PRO

Articolo	Lmm	€ Listino	
9866136	30	1,51	12
9866138	40	2,34	12
9866140	50	3,16	12
9866142	60	4,17	12
9866144	70	4,84	12

• Pennellessa krex ,adatta x smalti ad acqua ed impregnanti.



PENNELLO SETOLE BIO MANICO LEGNO SPESSORE 15mm



PRO

Articolo	Lmm	€ Listino	
9866160	20	1,46	12
9866162	30	1,77	12
9866164	40	2,10	12
9866166	50	2,98	12
9866168	60	4,14	12
9866170	70	5,47	12

• Pennellessa professionale. pura setola adatta x vernici a solvente,universale.



PENNELLO RADIATORE IN SETOLA MANICO LEGNO SPESSORE 10mm



PRO

Articolo	Lmm	€ Listino	
9866148	20	1,31	12
9866150	30	1,40	12
9866152	40	1,95	12
9866154	50	2,25	12
9866158	70	3,07	12

• Pennello radiatore in pura setola ,adatto per idropitture e quarzi.



PENNELLESSE SETOLA BIONDA



PRO

Articolo	Lmm	€ Listino	
9866442	20	0,40	36
9866443	30	0,55	36
9866445	50	0,71	36

Per informazioni tecniche, foto e prezzi aggiornati visita il nostro sito www.cillisrl.com

SET 10 PENNELLI VARI USI



Articolo	€ Listino	
9866118	3,00	36

PENNELLO PER RADIATORI



Articolo	Lmm	€ Listino	
9866510	30	1,00	24
9866511	40	1,20	24
9866513	60	1,50	24

PLAFONIERA SETOLE SINTETICHE



PRO

Articolo	Lmm	€ Listino	
9866172	50x150	12,92	12

• Plafone adatto x quarzi ,guaina liquida ,calce e idropitture.

PLAFONCINO MISTO MANICO IN PLASTICA



PRO

Articolo	Lmm	€ Listino	
9866174	30x70	3,86	12
9866176	40x140	5,17	12

• Plafone economico adatto per guaina liquida e calce

PLAFONCINO PURA SETOLA



Articolo	Lmm	€ Listino	
9866474	50x150	9,00	24

RULLO PER VERNICIATURA LANA



Articolo	Lmm	€ Listino	
9866220	20x200	4,00	48



RULLO POLIESTERE BIANCO+RETE



PRO

Articolo	Lmm	€ Listino	
9866178	200	3,29	12



RULLO CORDONATO GIALLO



PRO

Articolo	Lmm	€ Listino	
9866236	200	5,24	10



RULLO CORDONATO BIANCO



PRO

Articolo	Lmm	€ Listino	
9866234	100	4,04	10



RICAMBIO RULLO VELOUR



PRO

Articolo	Lmm	€ Listino	
9866186	50	0,64	20
9866188	100	0,70	10



MANICO ARCHETTO CORTO



PRO

Articolo	Lmm	€ Listino	
9866190	Ø 6x50	0,89	30



MANICO ARCHETTO LUNGO



PRO

Articolo	Lmm	€ Listino	
9866192	Ø 6x50	0,89	30

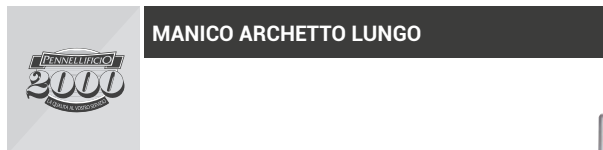

MANICO ARCHETTO LUNGO



PRO

Articolo	Lmm	€ Listino	
9866194	Ø 6x100	0,90	30



ADATTATORE DA ATTACCO VITE A CONICO



PRO

Articolo	€ Listino	
9686177	1,80	12

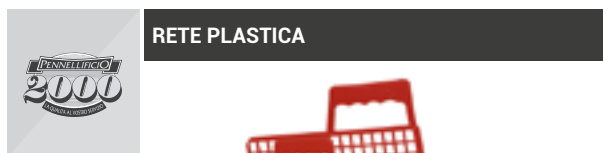

RETE PLASTICA



PRO

Articolo	Lmm	€ Listino	
9866238	100	0,54	50
9866239	200	0,72	50



Per rastrelli, r PORTAPENNELLO ACCIAIO



PRO

Articolo	€ Listino	
9866245	5,12	30

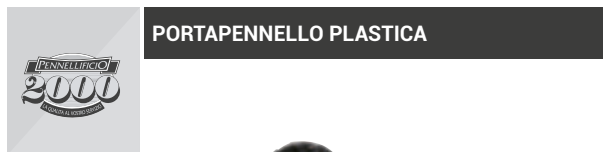

PORTAPENNELLO PLASTICA



PRO

Articolo	€ Listino	
9866250	2,34	30



TAMPONE TONDO PER DECORATIVI



PRO

Articolo	€ Listino	
9866255	8,00	30



SET 9 PENNELLI PUNTA PIATTA

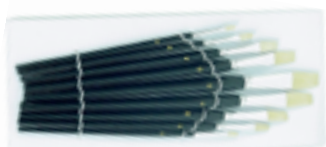

Articolo	€ Listino	
9866209	2,40	60

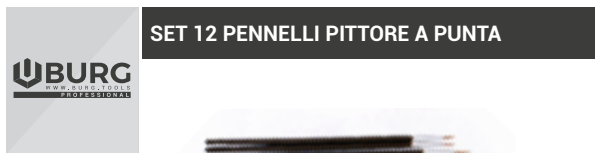

SET 12 PENNELLI PITTORE A PUNTA



Articolo	€ Listino	
9866212	2,60	60

PISTOLA PER SILICONE PROFESSIONALE



Articolo	Lmm	€ Listino	
9865180	230	8,50	24

• Diametro cartuccia massimo 47 mm

PISTOLA SILICONE ALLUMINIO PROFESSIONALE



Articolo	Lmm	€ Listino	
9865121	270	5,00	48

• Diametro cartuccia massimo 47 mm

PISTOLA SILICONE A CREMAGLIERA



Articolo	Lmm	€ Listino	
9865110	215	3,10	24

• Diametro cartuccia minimo 47 mm

PISTOLA SILICONE ALLUMINIO



Articolo	Lmm	€ Listino	
9865120	260	3,30	24

• Diametro cartuccia massimo 47 mm

PISTOLA TERMOCOLLANTE 60W



Articolo	€ Listino	
9824040	8,50	20

SET 12 BASTONCINI COLLA

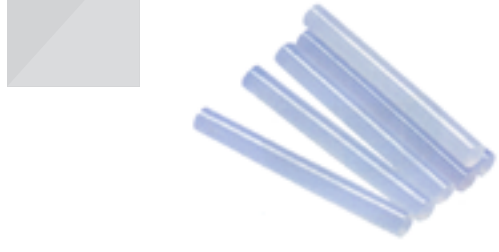

Articolo	Lmm	€ Listino	
9824112	11,2x100	2,20	72



Per informazioni tecniche, foto e prezzi aggiornati visita il nostro sito www.cillisrl.com

SET 4 SCALPELLI LEGNO FALEGNAME



Articolo	Lmm	€ Listino	
9862004	6 -10 -16 -20	8,80	24

DIMA TAGLIA CORNICI CON SEGA



Articolo	€ Listino	
9859505	4,26	24

CALIBRO NYLON



Articolo	Lmm	€ Listino	
9868705	150	1,00	72

CALIBRO DECIMALE INOX IN SCATOLA



Articolo	Lmm	€ Listino	
9868725	150	12,00	6

MARTELLINO MANICATO DIN1041



Articolo	kg	€ Listino	
9810101	0,100	3,12	48
9810201	0,200	3,50	48
9810301	0,300	5,00	24
9810401	0,400	6,00	24
9810501	0,500	6,56	24
9811001	1,000	7,25	24

• Testa in acciaio verniciato, battente lucido, innesto con cunei metallici manico in legno rifinito a mano.



MARTELLINO TIPO AMERICA MANICATO



Articolo	€ Listino	
9813025	3,00	24

MARTELLINO CARPENTIERE CON CALAMITA MANICO FIBRA



Articolo	kg	Lmm	€ Listino	
9912121	0,300	500	8,00	12

• Testa in acciaio forgiato con calamita, battente quadro piano e penna levachiodi, manico in fibra di vetro

MAZZA A COPPIA MANICATA



Articolo	Kg	€ Listino	
9684296	4,000	36,00	4

**MAZZETTA MANICATA
MANICO FIBRA TUV-GS-DIN6475**



Articolo	Kg	€ Listino	
9812081	0,800	7,00	24
9812101	1,000	8,10	24
9812126	1,250	8,50	24

**SET 2 SCALPELLI TAGLIO+PUNTA
CON PARAMANO**



Articolo	Lmm	€ Listino	
9862230	300	4,00	48

SCALPELLO PROFESSIONALE



Articolo	Lmm	Tipo	€ Listino	
9862235	300x18	Punta	3,50	36

**MARTELLINA MALEPPEGGIO
CON MANICO IN LEGNO**



Articolo	Kg	Lmm	€ Listino	
9912148	0,500	360	5,00	48

**MARTELLINA CATANIA
CON MANICO IN FIBRA**



Articolo	Kg	Lmm	€ Listino	
9912106	0,400	385	7,00	48

**MANICO MAZZETTA
IN FIBRA**



Articolo	Lmm	€ Listino	
9686560	250	3,00	20

Per informazioni tecniche, foto e prezzi aggiornati visita il nostro sito www.cillisrl.com

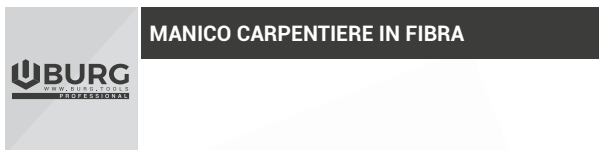

MANICO CARPENTIERE IN FIBRA



Articolo	Lmm	Ø	€ Listino	
9686551	500	40x25mm	5,00	20

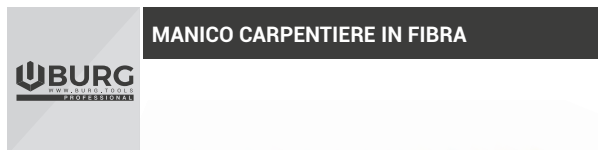

MANICO CARPENTIERE IN FIBRA



Articolo	Lmm	Ø	€ Listino	
9686540	370	40x25mm	3,30	20
9686550	500	50x29mm	4,00	20



TENAGLIA CEMENTISTA CROMO VANADIO



Articolo	Lmm	€ Listino	
9818018	225	5,00	72
9818020	250	5,40	72



TENAGLIA CEMENTISTA PRO CROMO VANADIO



PRO

Articolo	Lmm	€ Listino	
9818019	225	6,00	24
9818021	250	6,50	24

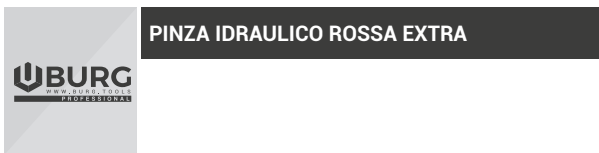

PINZA IDRAULICO ROSSA EXTRA



Articolo	Lmm	€ Listino	
9815660	250	6,40	24



PINZA IDRAULICO CROMO VANADIO EXTRA



PRO

Articolo	Lmm	€ Listino	
9815650	250	8,40	24



GIRATUBI CROMO VANADIO TIPO SVEDESE 45°



PRO

Articolo	Tipo	€ Listino	
9817210	1"	15,00	24
9817218	1,5"	17,00	12
9817222	2"	30,00	12



GIRATUBI TIPO SVEDESE 90°



Articolo	Tipo	€ Listino	
9817010	1"	5,70	12

CHIAVE STILLSON



Articolo	Tipo	€ Listino	
9817110	10"	5,00	12

PINZA TIPO GRIP



Articolo	Lmm	€ Listino	
9816250	250	6,00	24

Per informazioni tecniche, foto e prezzi aggiornati visita il nostro sito www.cillisrl.com

CESOIA PER TUBI PVC



Articolo	Lmm	€ Listino	
9862301	38	6,30	12

CESOIA PER TUBI PVC



Articolo	Lmm	€ Listino	
9862303	42	8,00	12

TAGLIATUBO



Articolo	Tipo	€ Listino	
9862320	2"	18,00	6

SET IDRAULICO 9 PEZZI IN VALIGETTA



Articolo	€ Listino	
9862330	35,80	5

CONTIENE:

- 1pz. Cesoia per tubi 1-5/8", 42mm
- 1pz. Tagliatubo a rotella 1/8"-1-1/8"
- 1pz. Tagliatubo mini 1/8"-7/8", 3-22mm
- 1pz. Cartellatrice flangitubi 3/16"-1/4"-3/16"5/16"-3/8"-1/2"
- 4pz. Piega tubi a molla 3/16"-1/4"-3/8"-1/2"

SET IDRAULICO 7 PEZZI IN VALIGETTA



CONTIENE:

- 1pz. Tagliatubo a rotella 1/8"-1 1/8"-3-28mm
- 1pz. Suasatore
- 1pz. Cartellatrice flangitubi 3/16" 1/4"-3/16"-5/16"*3/8"-1/2"
- 4pz. Piega tubi a molla 3/16" 1/4"-3/8"-1/2"

Articolo	€ Listino	
9862325	19,60	10



FILIERA IN VALIGETTA



Articolo	Dimensioni	€ Listino	
9862309	3/8"-1/2"-3/4"-1"-1 1/4"	50,00	4

CONFEZIONI MASCHI+FILIERE



Articolo	Pz	€ Listino	
9862420	20	22,00	6

PINZA FUSTELLATRICE PROFESSIONALE



Articolo	Lmm	€ Listino	
9818350	250	4,00	12

PINZA FUSTELLATRICE PROFESSIONALE



Articolo	Lmm	€ Listino	
9818355	240	6,00	60

• Corpo in resistente materiale plastico. Gancio di arresto in posizione chiusa. 6 Fustelle intercambiabili con fermo della fustella prescelta.

PINZA RIVETTATRICE CON 4 ADATTATORI E 50 RIVETTI



Articolo	€ Listino	
9818250	7,00	12

PINZA RIVETTATRICE CON 4 ADATTATORI



Articolo	€ Listino	
9818200	9,00	12

MORSETTO FALEGNAME



Articolo	Lmm	€ Listino	
9821150	150x50	2,45	72
9821200	200x50	2,50	48
9821250	250x50	2,60	48
9821312	300x120	8,50	12
9821512	500x120	8,80	12

MORSETTO RAPIDO MANICO ALLUMINIO



Articolo	Lmm	€ Listino	
9822120	100	3,50	24



SET 3 MORSETTI A C



Articolo	Lmm	€ Listino	
9823003	25-50-75	4,20	48

SET 10 MORSETTI ASSORTITI



Articolo	€ Listino	
9822202	12,50	12

SET MORSETTI RAPIDI



Articolo	Lmm	Pz	€ Listino	
9824010	65	5	2,40	36
9824011	85	4	2,40	72
9824012	120	2	2,40	72

SET 6 CACCAVITI DI PRECISIONE

• Il set comprende 3 cacciaviti a spacco e 3 a croce



Articolo	€ Listino	
9871365	1,00	48

SET 6 CACCAVITI DI PRECISIONE

• Il set comprende 4 cacciaviti a spacco e 2 a croce



Articolo	€ Listino	
9871407	1,50	96

MARTELLO - GIRAVITE CON 6 BITS



Articolo	€ Listino	
9981073	0,80	12

• Martello doppio uso. Svitando la testa del martello si possono montare sul manico i bits in dotazione, così da diventare un pratico giravite. Vano porta bits nel manico.

SET 11 BITS ASSORTITI

• Il set comprende 2 punte a spacco, 4 a croce, 4 a stella e 1 esagonale.



Articolo	€ Listino	
9824002	1,50	60

ASSORTIMENTO 25 UTENSILI



Articolo	€ Listino	
9870139	5,00	24

BURG
WWW.BURG.TOOLS

TAGLIABULLONI EXTRA



Articolo	Lmm	€ Listino	
9863438	450	14,00	8
9863444	600	19,00	8
9863450	750	25,00	4

BURG
WWW.BURG.TOOLS

CESOIA LATTONIERE GS



PRO

Articolo	Lmm	€ Listino	
9863325	250	7,00	24

BURG
WWW.BURG.TOOLS

TRONCHESE CROMO



Articolo	Lmm	€ Listino	
9815416	180	4,00	48

BURG
WWW.BURG.TOOLS

PINZA UNIVERSALE



Articolo	Lmm	€ Listino	
9814008	200	3,20	48

BURG
WWW.BURG.TOOLS

PINZA UNIVERSALE CROMO



Articolo	Lmm	€ Listino	
9814010	200	5,16	40

BURG
WWW.BURG.TOOLS

SET 3 PINZE BURG CROMO VANADIO



Articolo	€ Listino	
9815610	18,00	24



Per informazioni tecniche, foto e prezzi aggiornati visita il nostro sito www.cillisrl.com

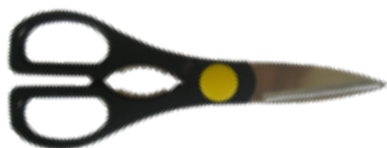

Articolo	Lmm	€ Listino	
9861515	200	1,50	20



PRO

Articolo	Lmm	€ Listino	
9861505	150	6,20	36



PRO

Articolo	Lmm	€ Listino	
9861512	200	5,00	30



PRO

Articolo	€ Listino	
9921958	7,00	10

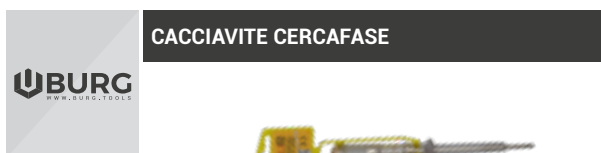

PRO

Articolo	Lmm	€ Listino	
9872340	140	0,80	60



PRO

Articolo	Dimensioni	€ Listino	
9871375	8-10-15-20-25	5,00	48

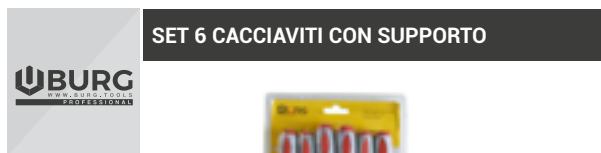

PRO

Articolo	€ Listino	
9871247	7,00	72

• Il set comprende 3 cacciaviti a spacco e 3 a croce



PRO

Articolo	€ Listino	
9871250	4,50	48

• Il set comprende 3 cacciaviti a spacco e 2 a croce

SET 2 CACCAIVITI CROMO VANADIO



PRO

Articolo	€ Listino	
9871225	1,60	60

SET 6 CACCAIVITI CROMO VANADIO CON SUPPORTO



PRO

Articolo	€ Listino	
9872650	15,00	36

• Il set comprende 3 cacciaviti a spacco e 3 a croce

SET 6 CACCAIVITI CROMO VANADIO CON CUSTODIA



PRO

Articolo	€ Listino	
9872660	18,00	24

• Il set comprende 3 cacciaviti a spacco e 3 a croce

SET 7 CACCAIVITI DI PRECISIONE CROMO VANADIO



PRO

Articolo	€ Listino	
9872610	10,00	20

CACCAIVITE TAGLIO CROMO VANADIO



PRO

Articolo	Lmm	€ Listino	
9872407	4x75	1,50	96
9872410	4x100	1,80	36
9872420	5x125	2,20	36
9872430	6x150	2,50	24
9872440	8x150	3,20	24

• Prodotto professionale, realizzato in acciaio CROMO VANADIO
Impugnatura ergonomica bimatereale.

CACCAIVITE CROCE CROMO VANADIO



PRO

Articolo	Lmm	€ Listino	
9872460	1x75	2,60	36
9872480	2x100	2,90	24

• Prodotto professionale, realizzato in acciaio CROMO VANADIO
Impugnatura ergonomica bimatereale.

SET CACCAIVITE- 12 IN 1 CROMO VANADIO



PRO

Articolo	€ Listino	
9872630	8,40	48



Per informazioni tecniche, foto e prezzi aggiornati visita il nostro sito www.cillisrl.com

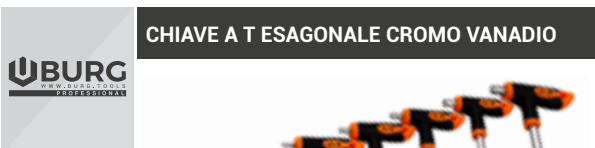

CHIAVE A T ESAGONALE CROMO VANADIO



PRO

Articolo	Lmm	€ Listino	
9872510	2x75	1,20	48
9872530	4x75	1,50	48
9872540	5x100	1,80	36
9872550	6x100	2,00	36
9872560	7x150	2,20	36
9872570	8x150	2,50	24
9872580	9x200	3,00	24
9872590	10x200	3,60	24

• Prodotto professionale, realizzato in acciaio CROMO VANADIO
Impugnatura ergonomica antiscivolo

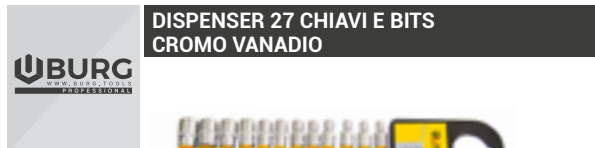

DISPENSER 27 CHIAVI E BITS CROMO VANADIO



PRO

Articolo	€ Listino	
9801816	19,60	12

• Contiene: 12-1/4"DR.BUSSOLE: 4-4.5-5-5.5-6-7-8-9-10-11-12-13MM; 14-1/4"DR.BUSSOLE BIT: SL4-5.5-7 PH1-PH2-T10-T15-T20-T25-T30-HW4-HW5-HW6 - 1-1/4" CHIAVE A CRICCHETTO



SET 44 CHIAVI E BITS CROMO VANADIO



PRO

Articolo	€ Listino	
9801844	40,00	3

• 13pz Bussole: 4-4.5-5-5.5-6-7-8-9-10-11-12-13-14; 1pz chiave a cricchetto; 2pz prolungha 50, 150mm; 1pz cacciavite per inserti; 1pz giunto universale; 1pz 3 adattatore; 1pz attacco a snodo; 23pz bussole bit: T8-9-10-15-20-25-27-30-40 PH1-2-3-, PZ1-2-3 FD 4-5, 5-7 H3-4-5-6-8
1PZ-VALIGETTA



CHIAVE INGLESE CROMATA



Articolo	Lmm	€ Listino	
9830010	250	6,50	12

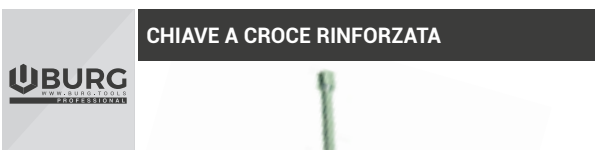

CHIAVE A CROCE RINFORZATA



Articolo	€ Listino		
9882055	17 x 19 x 21 x 1/2"	7,00	24



CHIAVE PER CANDELA



Articolo	Lmm	€ Listino	
9882058	16-21	5,00	60
9882060	21	3,70	60

Per informazioni tecniche, foto e prezzi aggiornati visita il nostro sito www.cillisrl.com



SET 3 LIME FERRO MANICATE



Articolo	Pz	€ Listino	
9873003	3	8,00	36



SET 3 RASPE MANICATE



Articolo	Pz	€ Listino	
9873013	3	8,00	36



BORSA 2 TASCHE IN PELLE



Articolo	€ Listino	
9826210	4,00	24



PORTATENAGLIE IN CUOIO



VERA PELLE

Articolo	€ Listino	
9660177	2,32	24



PORTAMATASSINA CON PORTATENAGLIA IN CUOIO PER CARPENTIERE



VERA PELLE

Articolo	€ Listino	
9660171	7,10	24



PORTAPINZE E CACCIAVITE IN CUOIO



VERA PELLE

Articolo	€ Listino	
9660172	7,10	24



PORTAMARTELLO IN CUOIO



VERA PELLE

Articolo	€ Listino	
9660173	2,60	24



FODERO PER ELETTRICISTI IN CUOIO



VERA PELLE

Articolo	€ Listino	
9660174	17,68	24

**BORSA PER ELETTRICISTA
IN CUOIO**



VERA PELLE

Articolo	Lcm	€ Listino	
9660178	40x14x24	48,96	1

**BORSA PER IDRAULICO
IN CUOIO**



VERA PELLE

Articolo	Lcm	€ Listino	
9660179	40x18x18	48,96	1

VALIGETTA PORTAUTENSILI DA 16"



Articolo	Lcm	€ Listino	
9826410	41,5x21,5x20	9,00	5

VALIGETTA PORTAUTENSILI DA 20"



Articolo	Lcm	€ Listino	
9826400	53x29x28	16,90	3

VALIGETTA MULTIUSO



Articolo	Lcm	€ Listino	
9826420	37,5x28,5x13	9,90	5

COMPIBOX GRANDE DA 16"



Articolo	Lcm	€ Listino	
9826430	35x25x5,5	7,20	5

**ORGANIZER FONDO NERO
CON ACCESSORI ROSSI 13 SCOMPARTI**



Articolo	Lcm	€ Listino	
9826440	41,4x33,8x7,9	27,00	2



CASSETTIERA 6 CASSETTI TRASPARENTI



Articolo	Lcm	€ Listino	
9826450	60x9,5x11,5	9,00	5

PANNELLO PORTAUTENSILI CON 4 CONTENITORI



Articolo	Lcm	€ Listino	
9826470	51,5x50x65	10,80	6

SET 4 TRIVELLINI



Articolo	Lmm	€ Listino	
9846004	2-4-5-6	3,00	36

LAMA TONDA DIAMANTATA



Articolo	Lcm	€ Listino	
9856400	30	3,00	24

SET 80 LAME ULTAFLES EXTRA FLESSIBILI



Articolo	Lcm	€ Listino	
9856500	31	20,00	1

LAMA BIMETALLICO SWEDEN SANDVIK BAHCO



Articolo	Lcm	€ Listino	
9856550	30	1,96	100

SET LAME PER SEGRETTO DA TRAFORO



Articolo	Lcm	€ Listino	
9855083	20	1,50	24

MINI ARCHETTO CON LAMA IN BLISTER



Articolo	Lmm	€ Listino	
9855050	150	1,00	144

MINI ARCHETTO PROF CON LAMA



Articolo	€ Listino	
9855250	1,20	72

ARCHETTO MANICATO IN PLASTICA



Articolo	Lmm	€ Listino	
9855400	300	3,00	24

ARCHETTO A FERRO MANICO ALLUMINIO



Articolo	Lmm	€ Listino	
9855350	300	4,00	12

ESPOSITORE 10 PZ ARCHETTI



Articolo	€ Listino	
9855310	203,90	1

ARCHETTO PROFESSIONALE METALLO BAHCO 304



Articolo	Lmm	€ Listino	
9855304	300	8,40	10

CUTTER DOPPIO MULTIFUNZIONE 12 IN 1



PRO

Articolo	Lmm	€ Listino	
9861009	190	7,00	24

• Tagliavetro, Tagliapiastrelle, Tagliatappeto, Tagliatutto, Frangivetro, Affilacoltello, Affilatorbici, Affilacesoie, Tagliafilo, Pinza spellafil, Apribottiglie, Raschiavetro

CUTTER MULTIFUNZIONE 7 IN 1



PRO

Articolo	Lmm	€ Listino	
9861010	250	7,00	24

• Lama a gancio, Seghetto per legno, plastica. metallo Taglierino, Coltello hobby, Raschietto.

CUTTER METALLO MINI



PRO

Articolo	Lmm	€ Listino	
9861016	135x9	3,00	60



Per informazioni tecniche, foto e prezzi aggiornati visita il nostro sito www.cillisrl.com



CUTTER METALLO MAXI

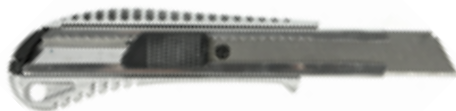

PRO

Articolo	Lmm	€ Listino	
9861017	155	3,50	48

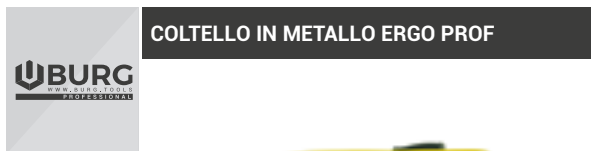

COLTELLO IN METALLO ERGO PROF



PRO

Articolo	Lmm	€ Listino	
9861305	170	4,00	48

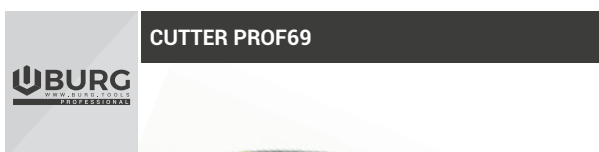

CUTTER PROF69



PRO

Articolo	Lama	€ Listino	
9861109	18 mm	2,00	60



CUTTER PROF21 CON CARICATORE AUTOMATICO 6 LAME



PRO

Articolo	Lama	€ Listino	
9861118	18 mm	4,30	60

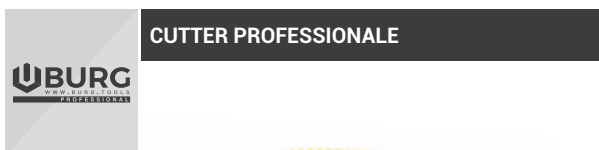

CUTTER PROFESSIONALE



PRO

Articolo	Lama	€ Listino	
9861120	18 mm	1,70	60

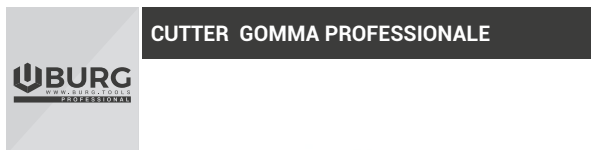

CUTTER GOMMA PROFESSIONALE



PRO

Articolo	Lama	€ Listino	
9861121	18 mm	2,00	144

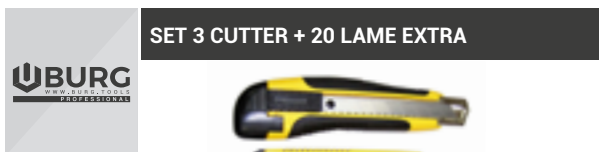

SET 3 CUTTER + 20 LAME EXTRA



PRO

Articolo	€ Listino	
9861125	5,66	48

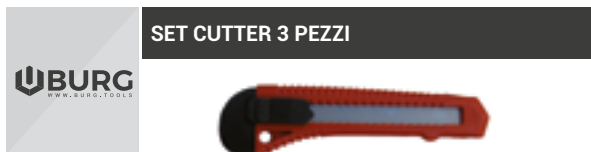

SET CUTTER 3 PEZZI



Articolo	€ Listino	
9861203	1,12	120



10 LAME CUTTER

Articolo	Lama	€ Listino	
9861018	18 mm	1,12	240



RASCHIETTO PROFESSIONALE

Articolo	€ Listino	
9861005	6,00	25



RASCHIETTO

Articolo	Lmm	€ Listino	
9861006	65	1,00	240



PINZA REGOLABILE 180 V 250

Articolo	€ Listino	
9903016	32,00	5



PINZA UNIVERSALE 150 B 180

Articolo	€ Listino	
9903020	24,70	5



SERIE DI GIRAVITI 325S7

Articolo	€ Listino	
9903018	50,20	3

• N°: PH 2x100 ; PH 1x80 ; 1.2x6.5x150 ; 1x5.5x125 ; 0.8x4x100 ; 0.5x3x75 ; 0.4x2.5x50.

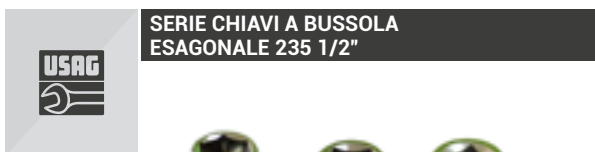

SERIE CHIAVI A BUSSOLA ESAGONALE 235 1/2"

Articolo	€ Listino	
9903034	27,40	5

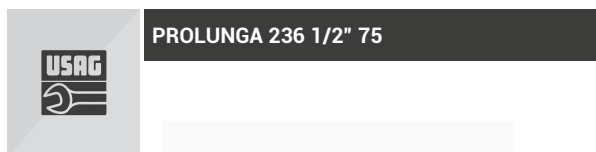

PROLUNGA 236 1/2" 75

Articolo	€ Listino	
9903042	10,65	3

• EN10 - EN13 - EN17 - EN19



Per informazioni tecniche, foto e prezzi aggiornati visita il nostro sito www.cillisrl.com



Articolo	€ Listino	
9903044	14,38	2

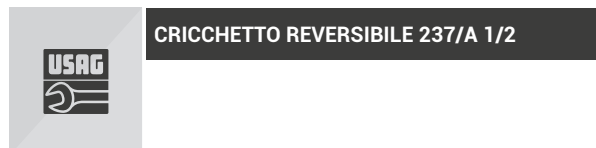

Articolo	€ Listino	
9903046	52,56	2

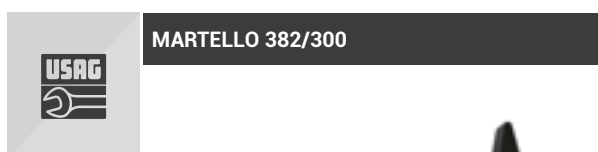

Articolo		€ Listino	
9903050	0,300	13,40	4

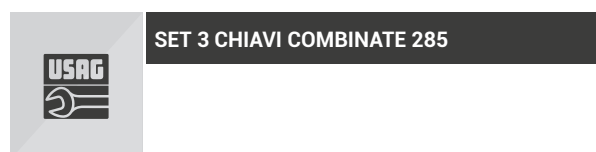

Articolo	N°	€ Listino	
9903024	8-10-13	24,10	10
9903028	17-19-22	41,62	5



Articolo	€ Listino	
9899010	27,00	6



ASSORTIMENTO 50 SPINE A SCATTO METRICHE



Articolo	€ Listino	
9917286 5-6-8-9-10-11	22,00	24

• Contiene: 16pz 5x36.5, 18pz 6x44.5, 6pz 8x44.5, 10pz 11x44.5



SET 555 COPPIGLIE SEMPLICI

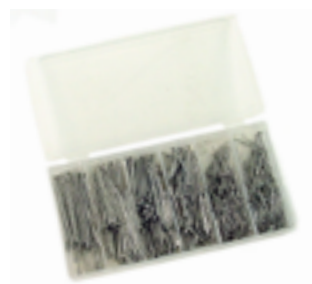

Articolo	€ Listino	
9917181	10,00	24

• Contiene: 150pz 1/16"x1", 150pz 3/32"x1"; 100pz 3/32"x1-1/2"; 75pz 1/8"x1-1/4"; 50pz 1/8"x2"; 30pz 5/32"x1-1/2"



ASSORTIMENTO 150 COPPIGLIE A MOLLA



Articolo	€ Listino	
9917215	8,00	24

• Contiene: 8pz 5/32"x2-5/16", 20pz 9/64"x1-3/4", 25pz 7/64"x1-5/8"; 25pz 3/32"x1-9/16"; 30pz 5/64"x1-5/16"; 42pz 3/32"x1-3/16"

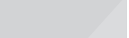

COPPIGLIA A MOLLA CADMIATA



Articolo	Lmm	€ Listino	
6900010	18	0,0507	200
6900020	20	0,0570	200
6900030	25	0,0774	200
6900040	30	0,0834	100
6900050	35	0,1135	100
6900060	40	0,1281	100
6900070	50	0,2030	50
6900080	60	0,2326	50

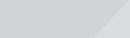

SET 150 COPPIGLI ASSORTIMENTO 150 DADI AUTOBLOCCANTI



Articolo	€ Listino	
9917253	7,50	24

• Contiene: 35pz 6-20, 25pz 6-28, 30pz 8-18; 25pz 10-16, 25pz 10-24; 10pz 12-13

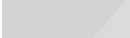

ASSORTIMENTO 110 INGRASSATORI



Articolo	€ Listino	
9917266	20,00	24

• Contiene: 60pz M6x1, 5pz M6x1 45°; 5pz M6x1 90°, 10pz M8x1.25; 5pz M8x1.25 45°; 5pz M8x1.25 90°; 5pz M10x1.5 45°; 5pz M10x1.5 90°, 10pz M10x1.5



ASSORTIMENTO 1200 RONDELLE ELASTICHE



Articolo	€ Listino	
9917268	9,00	24

• Contiene: 300pz M3, 300pz M4, 300pz M5, 150pz M6, 100pz M8, 50pz M10

ASSORTIMENTO 720 RONDELLE



Articolo	€ Listino	
9917178	4,50	24

• Contiene: 150pz #6, 150pz #8, 150pz #10, 120pz #1/4", 90pz #5/16", 60pz 3/8"

ASSORTIMENTO 300 ANELLI TENUTA ESTERNA



Articolo	€ Listino	
9917170	7,00	24

Contiene: 5-1-1/4" 10-1-1/8" 15-1-1/16" 15-1" 20-7/8" 15-13/16" 15-7/16" 15-15/32" 25-1/12" 15-9/16" 20-5/8" 25-3/4" 20-1/8" 10-5/32" 15-3/16" 25-1/4" 15-5/16" 20-3/8"

ASSORTIMENTO 225 O.R.



Articolo	€ Listino	
9917177	8,00	24

Contiene:
20pz 3x14, 4x1/4, 4.5x2,5x2mm
20pz 6x2, 6x2.5, 6x3, 7x2, 8x2mm
5pz 9x2, 10x2, 12x3, 13x3, 14x2.5, 17x2.5, 18x4, 20x2, 22x2mm

ASSORTIMENTO 225 ANELLI TENUTA INTERNA



Articolo	€ Listino	
9917179	7,50	24

Contiene: 15pz 11mm, 10pz 13mm, 10pz 14mm 15pz 16mm, 10pz 19mm, 10pz 20mm, 5pz 32mm, 15pz 8mm, 10pz 25mm, 10pz 22mm, 10pz 20mm, 15pz 19mm, 15pz 10mm, 15pz 16mm, 15pz 14mm, 15pz 12mm, 15pz 11mm, 15pz 6mm

ASSORTIMENTO 200 MOLLE



Articolo	€ Listino	
9917180	8,00	30

Contiene: 12pz 4x8mm, 8pz 4.7x45mm, 10pz 5x20mm,
10pz 5.5x17mm, 10pz 5.5x25mm, 10pz 5.5x38mm, 10pz 6x10mm, 10pz 6x22mm, 10pz 7x13mm,
10pz 7x19mm, 10pz 7x38mm, 12pz 7x72mm, 8pz 8x28mm, 10pz 8x32mm, 12pz 8x45mm,
10pz 8.7x36mm, 12pz 8.7x47mm, 8pz 9x36mm, 6pz 10x16mm, 12pz 10x19mm

ASSORTIMENTO 419 O.R. PROFESSIONALE



Articolo	€ Listino	
9917175	14,80	10

N.	Ø INT	Ø EST	KIT	N.	Ø INT	Ø EST	KIT	N.	Ø INT	Ø EST	KIT
R-01	3	6	20	R-07	10	15	14	R-13	19	24	13
R-02	4.4	8.4	20	R-08	11	16	13	R-14	21	26	14
R-03	5	8.4	18	R-09	13	18	14	R-15	22	29	13
R-04	7	10	23	R-10	14	19	13	R-16	18	25	10
R-05	10	13	23	R-11	16	21	14	R-17	20	27	10
R-06	13	16	23	R-12	18	23	14	R-18	22	29	10
N.	Ø INT	Ø EST	KIT	N.	Ø INT	Ø EST	KIT	N.	Ø INT	Ø EST	KIT
R-19	23.5	30.5	10	R-25	33	40	10	R-31	47	54	10
R-20	25	32	10	R-26	34.5	41.5	10	R-32	50	57	10
R-21	26.5	33.5	10	R-27	36	43	10				
R-22	28	35	10	R-28	38	45	10				
R-23	30	37	10	R-29	41	48	10				
R-24	31	38	10	R-30	44	51	10				

SET 58 VITI E DADI



Articolo	€ Listino	
9822159	1,22	60

SET 50 VITI TRUCCIOLARI



Articolo	€ Listino	
9822171	1,29	12

SET 130 VITI TRUCCIOLARI



Articolo	€ Listino	
9822178	1,47	12

SET VITI PER LEGNO



Articolo	Q.TÀ	mm	€ Listino	
9981101	90	25	1,50	48
9981102	70	40	1,50	48
9981103	80	32	1,50	48
9981104	60	50	2,00	48

SET 200 CHIODI FERRO



Articolo	€ Listino	
9822177	1,33	12

SET CHIODI 300 G



Articolo	mm	€ Listino	
9981109	75	1,50	48
9981112	50	1,50	48

SET 20 TASSELLI CON VITI



Articolo	mm	€ Listino	
9847890	8x100	2,00	60

SET 2 UTENSILI PER RECUPERO VITI E DADI

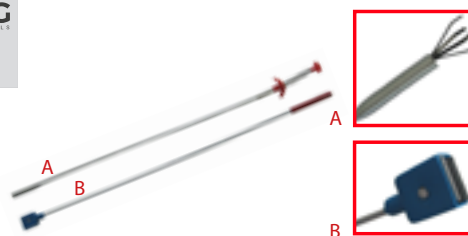

Articolo	€ Listino	
9982004	3,00	144

Il set comprende:

- un utensile flessibile con pinza;
- un utensile flessibile con calamita.

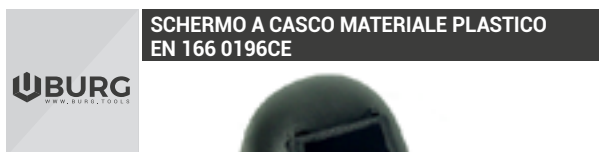

**SCHERMO A CASCO MATERIALE PLASTICO
EN 166 0196CE**



Articolo	€ Listino	
3153650	4,50	12



PINZA PORTAELETTRODI



Articolo	Amp	€ Listino	
3153710	500	4,66	40

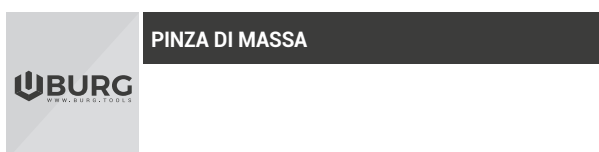

PINZA DI MASSA



Articolo	Amp	€ Listino	
3153750	600	3,50	48



PUNTE HSS AL COBALTO 8%



Articolo	Ø	€ Listino	
9911020	2,0-50 mm	0,95	100
9911025	2,5-55 mm	1,05	100
9911030	3,0-60 mm	1,15	100
9911035	3,5-70 mm	1,35	100
9911040	4,5-75 mm	1,50	100
9911050	5,0-85 mm	1,70	100
9911055	5,5-90 mm	1,90	100
9911060	6,0-95 mm	2,70	100
9911065	6,5-100 mm	2,70	100
9911070	7,0-110 mm	3,50	100
9911080	8,0-115 mm	4,55	100
9911085	8,5-115 mm	5,15	100
9911090	9,0-125 mm	6,35	100
9911095	9,5-125 mm	6,60	100
9911100	10,0-135 mm	9,00	50
9911110	11,0-145 mm	9,03	50
9911120	12,0-150 mm	11,75	50
9911125	12,5-150 mm	12,00	50

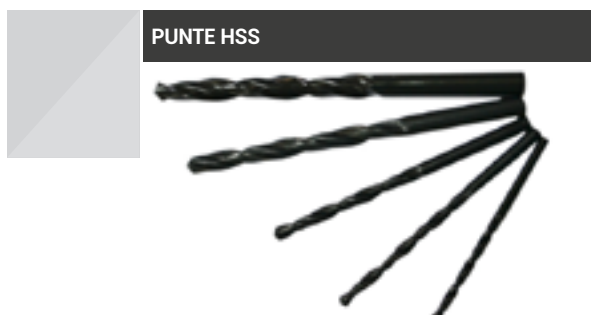

PUNTE HSS



Articolo	Ø	€ Listino	
9910010	1,0 mm	0,15	100
9910015	1,5 mm	0,17	100
9910020	2,0 mm	0,18	100
9910025	2,5 mm	0,18	100
9910030	3,0 mm	0,19	100
9910035	3,5 mm	0,19	100
9910040	4,0 mm	0,19	100
9910045	4,5 mm	0,20	100
9910050	5,0 mm	0,25	100
9910055	5,5 mm	0,30	100
9910060	6,0 mm	0,43	100
9910065	6,5 mm	0,43	100
9910070	7,0 mm	0,43	100
9910075	7,5 mm	0,44	100
9910090	9,0 mm	1,02	100
9910095	9,5 mm	1,05	100
9910100	10,0 mm	1,20	100
9910105	10,5 mm	1,43	100
9910110	11,0 mm	1,66	100
9910120	12,0 mm	1,78	100
9910130	13,0 mm	2,38	100



SERIE 19 PUNTE HSS PER FERRO



Articolo	€ Listino	
9840119	8,50	12

• Misure: 1 - 1,5 - 2 - 2,5 - 3 - 3,5 - 4 - 4,5 - 5 - 5,5 - 6 - 6,5 - 7 - 7,5 - 8 - 8,5 - 9 - 9,5 - 10

SERIE 13 PUNTE TITANIUM PER FERRO HSS



Articolo	€ Listino	
9840213	4,00	20

• Misure: 1,5 - 2 - 2,5 - 3 - 3,2 - 3,5 - 4 - 4,5 - 4,8 - 5 - 5,5 - 6 - 6,5



SERIE 19 PUNTE TITANIUM PER FERRO



Articolo	€ Listino	
9840219	11,60	24

• Misure: 1 - 1,5 - 2 - 2,5 - 3 - 3,5 - 4 - 4,5 - 5 - 5,5 - 6 - 6,5 - 7 - 7,5 - 8 - 8,5 - 9 - 9,5 - 10

SET 8 PUNTE PER MURO



Articolo	€ Listino	
9841008	2,50	48

• Misure: 3 - 4 - 5 - 6 - 7 - 8 - 9 - 10

PUNTE ELICOIDALI IN ACCIAIO ZINCATO DA MURO

Articolo	Ø	€ Listino	
9901030	3 mm	0,13	100
9901040	4 mm	0,16	100
9901050	5 mm	0,18	100
9901060	6 mm	0,20	100
9901070	7 mm	0,24	100
9901080	8 mm	0,27	100
9901090	9 mm	0,32	100
9901100	10 mm	0,40	100
9901120	12 mm	0,56	100
9901130	13 mm	0,56	100
9901140	14 mm	0,83	100
9901150	15 mm	0,90	100
9901160	16 mm	0,92	100



Per informazioni tecniche, foto e prezzi aggiornati visita il nostro sito www.cillisrl.com

UBURG
WWW.UBURG.TOOLS

**SELETTORE 18 PUNTE HCS+WIDIA+LEGNO
PER LEGNO FERRO E MURO**



Articolo	€ Listino	
9845018	4,50	24

• Misure: 3 - 4 - 5 - 6 - 8 - 10 per tipo

ELEMATIC

TASSELLO ELEMATIC T66/V TS TORX



Articolo	Ø	€ Listino	
5678510	8x80	0,372	50
5678520	8x100	0,435	50
5678530	8x120	0,488	50
5678580	10x100	0,554	50
5678590	10x120	0,618	50
5678600	10x140	0,744	50
5678610	10x160	0,862	50

ELEMATIC

TASSELLO PA 6 T6/VA

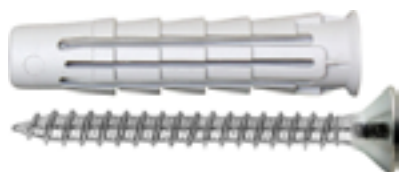

Articolo	Ø	€ Listino	
5653890	5x25	0,062	100
5653900	6x20	0,076	100
5653910	8x40	0,120	50
5653920	10x350	0,226	25

ELEMATIC

TASSELLO PA 6 ESB/VA

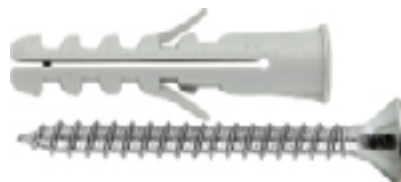

Articolo	Ø	€ Listino	
8702263	6x30	0,062	100
8702264	8x40	0,100	50
8702265	10x50	0,172	50

ELEMATIC

TASSELLO PA 6 ENP/V



Articolo	Ø	€ Listino	
8700001	9x40	0,166	200
8700020	12x45	0,212	100

ELEMATIC

TASSELLO PA 6 ENP/GC



Articolo	Ø	€ Listino	
8700003	9x40	0,174	200
8700022	12x45	0,212	100

TASSELLO PA 6 ENP/GM

ELEEMATIC



Articolo	Ø	€ Listino	CFM
8700005	9x40	0,170	200
8700024	12x45	0,230	100

TASSELLO PA 6 ENP/GL

ELEEMATIC



Articolo	Ø	€ Listino	CFM
8700007	9x40	0,176	100
8700026	12x45	0,228	50

TASSELLO PA 6 ENP/OA

ELEEMATIC



Articolo	Ø	€ Listino	CFM
8700009	9x40	0,20	100
8700028	12x45	0,248	50

TASSELLO PA 6 ENP/OCC

ELEEMATIC



Articolo	Ø	€ Listino	CFM
8700011	9x40	0,20	100
8700030	12x45	0,248	50

ANCORINA ETAF/V

ELEEMATIC



Articolo	Ø	€ Listino	CFM
8706001	4/12	0,462	50

ANCORINA ETAF/OC

ELEEMATIC

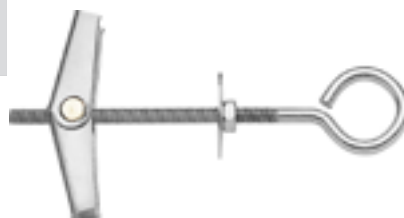

Articolo	Ø	€ Listino	CFM
8706101	4/12	0,466	50

ANCORINA ETAF/OA

ELEEMATIC



Articolo	Ø	€ Listino	CFM
8706201	4/12	0,490	50

ANCORINA ETAF/DD

ELEEMATIC



Articolo	Ø	€ Listino	CFM
8706301	4/12	0,48	50

Per informazioni tecniche, foto e prezzi aggiornati visita il nostro sito www.cillisrl.com

TASSELLO ACCIAIO LE/B M

ELEMATIC



Articolo		€ Listino	CFM
8717101	6x55	0,606	50
8717102	8x60	0,728	50
8717103	10x80	1,30	25
8717104	12x90	1,80	20

ANCORANTE T11

ELEMATIC



Articolo		€ Listino	CFM
8716328	8x75	0,326	100
8716306	8x90	0,332	100
8716308	10x75	0,380	50
8716309	10x95	0,400	50
8716310	10x120	0,480	25
8716315	12x110	0,616	25
8716316	12x140	0,750	25
8716333	12x160	0,812	20
8716319	14x120	1,224	20
8716320	14x160	1,366	20

SET 2 CARBONCINI



Articolo	Tipo	€ Listino	
9830520	1,0 cm	0,80	60
9830530	1,5 cm	1,00	60

MANDRINO A CREMAGLIERA ATTACCO FILETTATO



Articolo	Punta-Filetti	€ Listino	
9830110	1-10 3/8"-24	4,00	24
9830120	1-13 1/2"-20	8,00	24

MANDRINO AUTOSERRANTE ATTACCO FILETTATO

UBURG



Articolo	Punta-Filetti	€ Listino	
9830140	1-13 1/2"-20	8,50	24

ASSORTIMENTO 5 MOLETTE PER TRAPANO

UBURG



Articolo	€ Listino	
9873405	2,20	72

SET 5 RASPE PER TRAPANO

UBURG



Articolo	€ Listino	
9873415	3,24	36

SERIE NECCHIE

UBURG



Articolo	Lmm	€ Listino	
9844006	10-12-16-18-20	4,28	12

SERIE 3 SBAVATORI ATTACCO DA 6 mm



Articolo	Lmm	€ Listino	
9844013	12-16-19	4,00	12

SERIE 7 LAME A TAZZA



Articolo	Ø mm	€ Listino	
9858002	26-32-38-46-50-57-62	4,00	24

SET FRESE A TAZZA 10 PZ





Articolo	Ø mm	€ Listino	
9858811	Da 19 a 64	9,00	12

SET FRESE HSS A TAZZA 9 PZ



PRO

Articolo	Ø mm	€ Listino	
9858843	Da 22 a 64	48,00	3

SET 2 FRESE SDS PLUS 160 mm

Articolo	Ø mm	€ Listino	
9920627	65-80	39,00	6

SET 3 SPAZZOLE ATTACCO TRAPANO



Articolo	€ Listino	
9874003	2,20	24

SPAZZOLA A FORO 14 RITORTO



Articolo	Ø mm	€ Listino	
9875120	75	3,32	24
9875122	100	4,50	12
9875125	125	8,80	12

SPAZZOLA A FORO 14



Articolo	Ø mm	€ Listino	
9875107	75	3,30	36
9875109	100	4,40	60
9875110	125	6,00	45

Per informazioni tecniche, foto e prezzi aggiornati visita il nostro sito www.cillisrl.com

SPAZZOLA CIRCOLARE



Articolo	Ø	€ Listino	
9875130	100 mm	3,00	30

DISCO DIAMANTATO



Articolo	Ø	€ Listino	
9873525	115 mm	3,00	24

DISCO DIAMANTATO TURBO



Articolo	Ø	Grado	€ Listino	
9873527	115 mm	C	4,00	24
9873534	230 mm	A	13,00	12

- Grado A : capacità di taglio per circa 100m-diamante perc. 24%
- Grado C : capacità di taglio per circa 40-50m -diamante perc. 18-20%

DISCO TURBO BURG



PRO

Articolo	Ø	€ Listino	
9873545	115 mm	5,20	48

DISCO LAMELLARE PROFESSIONALE CON SUPPORTO IN FIBRA CORINDONE



Articolo	Ø	Grana	€ Listino	
9873804	115	40	1,74	20
9873806	115	60	1,74	20
9873808	115	80	1,74	20
9873810	115	100	1,74	20
9873812	115	120	1,74	20

ESPOSITORE 180 DISCHI ABRASIVI



Articolo	Ø	€ Listino	
9873868	115	222,00	1

- Contiene:
- 50 Pz 115x1,0 ima ferro/inox (5x10 in termoretrato)
- 50 Pz 115x1,6 ima ferro/inox (5x10 in termoretrato)
- 50 Pz 115x1,6 ima multi gold (5x10 in termoretrato)
- 10 Pz 115x22 ima disco lamellare supporto fibra corindone 40 gr.
- 10 Pz 115x22 ima disco lamellare supporto fibra corindone 60 gr.
- 10 Pz 115x22 ima disco lamellare supporto fibra corindone 80 gr.



DISCO TRONCATRICE FERRO PROFESSIONALE



Articolo	Misure	€ Listino	
9873850	300x2,8x25	4,08	35

• Velocità max: 5.100 R.P.M. m/s



DISCO TAGLIO FERRO-INOX PROFESSIONALE



Articolo	Misure	€ Listino	
9873816	115x1	1,10	50
9873818	115x1,6	1,10	50
9873820	230x2	2,32	50

• Foro: 22,23 mm. Tipo piano



DISCO MULTI GOLD IMA



Articolo	Misure	€ Listino	
9873835	115x1,6x22	1,50	30

• Velocità max: 13.300 R.P.M. m/s. Utilizzabile per taglio di materiali edili, plastica, legno, alluminio e altri metalli.



DISCO MARMO C30R



Articolo	Misure	€ Listino	
9873860	115x2,5x22	1,10	50

• Velocità max: 10.200 R.P.M. m/s. Utilizzabile per taglio di materiali duri come marmo e pietre.



DISCO MARMO GOLD



Articolo	Misure	€ Listino	
9873864	115x1,6x22 C46R	1,20	50
9873862	230x3,2x22 C30R	2,48	50

• 9873862: Velocità max: 6.650 R.P.M. m/s
 • 9873864: Velocità max: 13.300 R.P.M. m/s
 Utilizzabile per taglio di materiali duri come marmo



DISCO GRES GOLD



Articolo	Misure	€ Listino	
9873866	115x1,6x22 C46N	1,36	50

• Velocità max: 13.300 R.P.M. m/s
 Utilizzabile per taglio di materiali come gres.



SPUGNETTA ABRASIVA GRANA MEDIA



Articolo	Misure	€ Listino	
9873890	95x70x25	0,66	50



CARTA SPAZIATA ROLO 5MT 115MM



Articolo	Grana	€ Listino	
9873870	40	3,98	18
9873872	60	3,68	20
9873874	80	3,36	20
9873876	100	3,12	20
9873878	120	3,12	20
9873880	150	3,12	20

Per informazioni tecniche, foto e prezzi aggiornati visita il nostro sito www.cillisrl.com



**SPAZZOLA
MANICO PLASTICA**

Articolo	Imballo	€ Listino	
9875009	Blister	2,00	48
9875010	Sfuso	1,80	48



MOLA RICAMBIO PER SMERIGLIATRICE

Articolo	Misure	€ Listino	
9995615	15x12,7x20	2,00	12

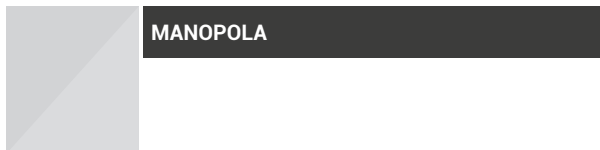

MANOPOLA

Articolo	Ø	Lmm	€ Listino	
0506905	30	92	0,44	30
0506910	32	92	0,51	30



**MANOPOLA
PER CARRIOLA 0506120**

Articolo	Ø	€ Listino	
0506930	25	0,80	30



Articolo	Ø	Colore	€ Listino	
0506919	19	Bianco	0,50	50
0506925	25	Giallo	1,00	50
0506928	28	Nero	0,60	50



**RUOTA ANTIFORO GOMMA POLIURETANO
PIENA GIALLA**

Articolo	Lmm	Boccola	€ Listino	
0506805	360x80	155 mm	24,40	6
0506807	360x80	120 mm	24,40	6

• Ruota antiforo con interno riempito in schiuma poliuretanaica.
Cerchio in acciaio verniciato, adatto ai carichi pesanti. Asse 210x10mm



RUOTA PIENA TACCHETTATA GIALLA

Articolo	Lmm	€ Listino	
0506809	360x80	22,00	6

• Boccola 120 mm
• Asse 210x10 mm



**RUOTA PNEUMATICA 2PR
PER CARRIOLA MURATORI**

Articolo	Lmm	€ Listino	
0506800	360x80	16,50	12
0506801	Camera d'aria	3,00	12

• Boccola 155 mm • Asse 210x10 mm



**RUOTA PNEUMATICA CON CERCHIO
IN PLASTICA**

Articolo	Lmm	€ Listino	
0506890	400x80	17,64	12

• Boccola 75 mm con rulli

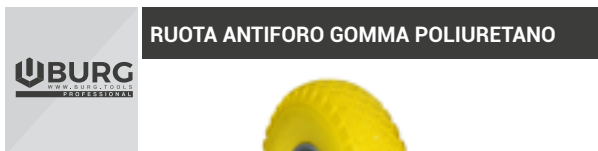

PRO

Articolo	Lmm	€ Listino	
0506850	250x72	15,00	6

- Ruota antiforo con interno riempito in schiuma poliuretana. Cerchio in acciaio verniciato, adatto ai carichi pesanti. Rulli interni in acciaio.
- Foro 20 mm
- Lunghezza da boccola a boccola 75 mm



PRO

Articolo	Lmm	€ Listino	
0506815	255x80	17,80	6

- Ruota antiforo con interno riempito in schiuma poliuretana. Cerchio in acciaio verniciato, adatto ai carichi pesanti. cuscinetti in acciaio.
- Foro 20 mm
- Lunghezza da cuscinetto a cuscinetto 70 mm



PRO

Articolo	Lmm	€ Listino	
0506855	250x72	14,34	6

- Ruota antiforo con interno riempito in schiuma poliuretana. Cerchio in plastica.
- Foro 20 mm
- Lunghezza da boccola a boccola 75 mm



PRO

Articolo	Lmm	€ Listino	
0506817	255x80	18,00	6

- Ruota antiforo con interno riempito in schiuma poliuretana. Cerchio in acciaio verniciato.
- Foro 20 mm
- Lunghezza da boccola con cuscinetto 75 mm



PRO

Articolo	Lmm	€ Listino	
0506861	260x85	8,00	10

- Boccola decentrata.
- Sporgenza boccola 65 mm.



PRO

Articolo	Lmm	€ Listino	
0506820	260x85	10,60	10

- Foro 20 mm



PRO

Articolo	Lmm	€ Listino	
0506860	260x85	12,20	10

- Foro 20 mm



PRO

Articolo	Lmm	€ Listino	
0506863	260x85	11,46	10

- Foro 20 mm



Per informazioni tecniche, foto e prezzi aggiornati visita il nostro sito www.cillisrl.com



CAMERA D'ARIA



Articolo	Lmm	€ Listino	
0506865	260x85	2,40	10



RUOTA PNEUMATICA MOZZO METALLO



- Foro 20 mm
- PLY 2

Articolo	Lmm	€ Listino	
0506811	305x105	26,00	12



RUOTA PNEUMATICA MOZZO METALLO



- Foro 20 mm
- PLY 4

Articolo	Lmm	€ Listino	
0506810	305x120	30,00	12



RUOTA CON SUPPORTO FISSO



Articolo	Ø	€ Listino	
0506410	75	3,00	24
0506420	100	4,84	24
0506430	125	5,52	24
0506450	160	7,90	24



RUOTA CON SUPPORTO GIREVOLE



Articolo	Ø	€ Listino	
0506510	75	3,94	24
0506520	100	6,00	24
0506530	125	6,94	24
0506550	160	15,54	24



SET 4 RUOTE GOMMA 2 FISSE E 2 GIREVOLI



Articolo	Ø	€ Listino	
9859812	32	2,50	24
9859814	40	3,00	24



RUOTA IN POLIPROPILENE



Articolo	Ø	€ Listino	
9859816	60 Girevole	5,74	40
9859818	60 Fissa	4,20	40



RUOTA GIREVOLE IN POLIURETANO



Articolo	Ø	€ Listino	
0506685	100	25,29	6
0506690	125	31,00	4

RUOTA FISSA IN POLIURETANO



Articolo	Ø	€ Listino	
0506695	100	21,03	6
0506696	125	26,44	6

CARRELLO PORTATUTTO



Articolo	Lcm	Portata	€ Listino	
9859800	70x73x47	150 Kg	55,00	2

• Carrello portatutto portata massima 150 kg. Piano con rivestimento antiscivolo. Con maniglia richiudibile.

**SET 4 RUOTE NYLON
2 FISSE E 2 GIREVOLI**



Articolo	Ø	€ Listino	
9859813	40	2,80	24

SET 4 RUOTE PLASTICA GIREVOLI



Articolo	Ø	€ Listino	
9859815	40	3,00	24

**CARICABATTERIA MACH
214 6-12V 230V**



Articolo	€ Listino	
9996018	43,60	3

CARATTERISTICHE

Alimentazione (Volt 50-60Hz AC)	1 Ph x 230
Potenza	50 W
Tensione nominale	6/12 Volt
Corrente di carica media	2,5 Amp
Corrente di carica efficace	4 Amp
Posizioni di carica	1
Capacità batteria	15/60 Ah min/max
Dimensioni	225x160x95

• Ricarica batterie al piombo con elettrolita libero. Tensione di batteria 6 e 12V. Protezione contro le inversioni di polarità. Protezione contro i corto circuiti alle pinze.

SET 12 ACCESSORI PER DEMOLITORE ATTACCO SDS PLUS

- 5,6x110mm 8,10,12x160mm scalpello a punta: 14x250mm
- 14x200mm 16x210mm scalpello piatto: 14x250x20mm
- 18x300mm 20x450mm scalpello a cucchiaio: 14x250mm



Articolo	€ Listino	
9920626	30,00	6

PUNTA ATTACCO SDS PLUS



Articolo	Lmm	€ Listino	
9862255	5x110	1,10	30
9862256	6x110	1,15	30
9862260	10x160	1,28	30
9862262	12x160	1,74	30

SCALPELLO PIATTO ATTACCO SDS PLUS



Articolo	Lmm	€ Listino	
9862266	280x25	4,60	12

SCALPELLO PUNTA ATTACCO SDS PLUS



Articolo	Lmm	€ Listino	
9862267	280x17	4,00	12

SCALPELLO LARGO ATTACCO SDS PLUS



Articolo	Lmm	€ Listino	
9862270	400x30	6,70	12

HITACHI

PUNTA HITACHI HTA750991A SDSMAX



Articolo	Lmm	€ Listino	
9921110	400	8,00	6

HITACHI

PUNTA HITACHI CILINDRICA



Articolo	Lmm	€ Listino	
9921198	120x8,0	3,20	6

SET 2 STAFFE AD ANGOLO

Articolo	Lmm	€ Listino	
9824026	160x120	1,00	48



SET 4 STAFFE AD ANGOLO CON VITI

Articolo	Lmm	€ Listino	
9824027	50x15	1,00	60



SET 2 CERNIERE A LEGNO

Articolo	€ Listino	
9982187	2,50	24



SET 4 STAFFE PIATTE 4 FORI CON VITI

Articolo	Lmm	€ Listino	
9824028	75x13	1,00	72



Per informazioni tecniche, foto e prezzi aggiornati visita il nostro sito www.cillisrl.com

SET MANIGLIE PER PORTA OTTONATE



Articolo	Lmm	€ Listino	
9824006	200	1,50	72

CATENACCIO PER PORTA



Articolo	€ Listino	
9824029	1,00	60

SET 2 CATENACCI OTTONATI



Articolo	Lmm	€ Listino	
9824035	75	1,50	72

KIT 2 ANTIFURTO PER TAPPARELLE IN PLASTICA BIANCO



Articolo	€ Listino	
9913020	6,06	15

• Il punto più debole della tapparella è la giunzione tra elemento ed elemento; con facilità tagliabile.

Lo spazio minimo tra finestra e tapparella deve essere di 3,5cm per poter montare correttamente l'antifurto. Tasselli inclusi.

KIT PUNTE ANTILADRO PER GRONDAIE ACCIAIO ZINCATO MARRONE



Articolo	€ Listino	
9913030	50,10	2

• Il kit comprende: 6 barre da 40cm, 20 rivetti, 1 adesivo segnaletico.

PORTATUTTO 5 GANCI



Articolo	Lmm	€ Listino	
9982017	420	2,50	72

PORTAUTENSILI JUMBO A 5 GANCI



Articolo	Lmm	€ Listino	
9983421	475	2,00	96

SET 2 GANCI AD ANGOLO



Articolo	Lmm	€ Listino	
9983301	140x125x60	2,00	48

APPENDIABITI LEGNO



Articolo	Ganci	€ Listino	
9823223	3	1,60	48
9823225	4	2,20	48
9823228	6	2,40	48

SET 4 GANCI PER
ATTACCA PANNI



Articolo	€ Listino	
9824025	0,80	72

CINGHIA FISSAGGIO QUICKLOADER
1000/2000 KG 5 M UNCINO



PRO

Articolo	€ Listino	
8021220	43,89	3

NASTRO FISSAGGIO CARGO
CON CRICCHETTO



Articolo	Lmm	€ Listino	
9887150	50x6,5 mt	10,00	24

NASTRO FISSAGGIO CARGO
CON CRICCHETTO



Articolo	Lmm	€ Listino	
9887110	25x5 mt	6,00	48

NASTRO IN GOMMA QUICKLOADER
110 CM NERO



Articolo	€ Listino	
8021225	15,82	8

CONFEZIONE 200 GR
ELASTICI MISURE ASSORTITE



Articolo	Kg	€ Listino	
9982041	0,200	3,00	72

Per informazioni tecniche, foto e prezzi aggiornati visita il nostro sito www.cillisrl.com

SET 2 CORDE ELASTICHE



Articolo	Lcm	€ Listino	
9824280	2x100	1,50	72

CORDA TRECCIA MARINA



Articolo	Ø	€ Listino	
0690004	4 mm	4,90	20 Kg
0690005	5 mm	4,90	20 Kg
0690006	6 mm	4,90	20 Kg
0690008	8 mm	4,90	20 Kg
0690010	10 mm	4,90	20 Kg
0690012	12 mm	4,90	20 Kg
0690014	14 mm	4,90	20 Kg
0690016	16 mm	4,90	20 Kg
0690018	18 mm	4,90	20 Kg
0690020	20 mm	4,90	20 Kg

CORDA STENDINO 25 MT



Articolo	Ø	€ Listino	
0691006	3 mm	1,10	50

BOBINA CATENA ZINCATA

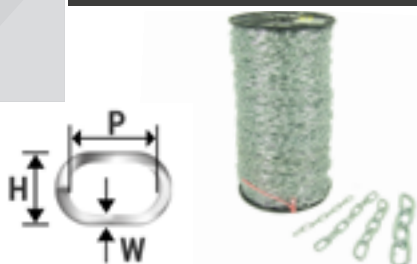

Articolo	"H"mm	"P" mm	"W" mm	€ Listino	
9879010	9	23	2,5	137,00	2
9879030	15	31	4	84,00	2
9879040	16	31	4	82,00	2
9879050	18	32	5	78,00	2
9879055	20	35	5	68,00	2
9879060	23	37	6	96,00	2
9879080	25	39	6	67,00	2

CAVETTO OTTONATO RIVESTITO BIANCO IN PVC



PRO

Articolo	Lmm	€ Listino	
8110200	5 x 500 mt	106,86	1

CARATTERISTICHE

Diametro	Peso gr indicativo per mt circa
4	13
5	20
6	28
8	48
10	75
12	120
14	138
16	178
18	215

CONFEZIONE CORDA TRECCIA EXTRA DA 20 MI



Articolo	Ø	€ Listino	
0690104	4 mm	2,30	36
0690105	5 mm	2,75	36
0690106	6 mm	3,00	36
0690108	8 mm	4,30	36
0690150	10 mm	9,30	36
0690152	12 mm	13,10	36
0690154	14 mm	18,00	36

SET 3 GOMITOLI JUTA



Articolo	Lmm	€ Listino	
9867008	1,5x125 mt	5,00	24

**SET 10 SPAGO
100 GRAMMI GREZZO**



Articolo	Ø	€ Listino	
9867103	2/3.4	9,30	10
9867104	2/2	12,10	10
9867105	2/4	14,60	10

**SET 10 SPAGO
100 GRAMMI CANDIDO PER ALIMENTI**



Articolo	Ø	€ Listino	
9867106	2/4	16,80	10

**BRACCIO TELESCOPICO 250 Kg MAX
IN ACCIAIO ZINCATO**



Articolo	Lcm	€ Listino	
0507918	110	65,00	4

**CAVO ACCIAIO ANTIGIRO
PER PARANCHI TIRAFILO DA 12 MT**



Articolo	Ø	€ Listino	
0507931	3	14,50	12

**CAVO ACCIAIO ANTIGIRO
PER PARANCHI TIRAFILO DA 100 MT**



Articolo	Ø	€ Listino	
0507932	3	60,00	3

PARANCO A CATENA 1 TONNELLATE 3 METRI



Articolo	€ Listino	
0507955	62,00	3

PARANCO A CATENA 2 TONNELLATE 3 METRI



Articolo	€ Listino	
0507985	78,00	3

Per informazioni tecniche, foto e prezzi aggiornati visita il nostro sito www.cillisrl.com

PORTALAMPADA E27 60W MAX



Articolo	€ Listino	
9899603	4,80	24

PORTALAMPADA CON TREPPIEDI CON LAMPADA 500 WATT



Articolo	Watt	Lcm	€ Listino	
9899470	500	80-200	30,00	3

- Rivestimento in metallo verniciato, Riflettore a lungo raggio d'illuminazione, Cavalletto telescopico. Lunghezza cavo 3 mt in dotazione.

LANTERNA LED POTENZA 200 LUMEN



Articolo	Potenza	€ Listino	
9881400	200	12,00	4

- Lampada a torretta. Autonomia 4 ore. Si accende alzando la parte superiore. Con batterie in dotazione.

TORCIA LED POTENZA 145 LUMEN



Articolo	Potenza	€ Listino	
9881405	145	7,62	6

- Batterie in dotazione

TORCIA LED POTENZA 180 LUMEN



Articolo	Potenza	€ Listino	
9881410	180	8,30	5

- Batterie in dotazione

TORCIA LED POTENZA 280 LUMEN



Articolo	Potenza	€ Listino	
9881415	280	12,24	5

- Batterie in dotazione

CATENA 180 LUCI LED 8 GIOCHI



Articolo	Colore	€ Listino	
9881420	Bianco	14,60	10
9881425	Calda	14,60	10
9881430	Multicolor	14,60	10

- Catena lineare, led Ø5mm memory controller. Trasformatore incluso 24V, uso interno/esterno. Potenza 3,40W. Lunghezza cavo 2+7,5 mt.

CATENA 300 LUCI LED 8 GIOCHI



Articolo	Colore	€ Listino	
9881435	Bianco	20,40	6
9881440	Calda	20,40	6
9881445	Multicolor	20,40	6

- Catena lineare, led Ø5mm memory controller. Trasformatore 24V, uso interno/esterno. Potenza 4,30W. Lunghezza cavo 2+12,5 mt.

ALBERO DI NATALE VERDE IN PVC

Articolo	Lcm	€ Listino	
4005200	120	37,00	2
4005205	150	64,00	2

• Albero Natale Pvc Verde FIEMME rami mix di diversa forma e colore, snodabili non asportabili, uso interno, piedistallo richiudibile in plastica, scatola bianca.



PROIETTORE EFFETTO MOVIMENTO GARDEN LASER VERDE E ROSSO

Articolo	Lcm	€ Listino	
9881460	Ø10x10xH20/33	107,80	2

• Proiettore Garden LASER VERDE & ROSSO, a 16m illumina un'area di Ø16m, Telecomando Multifunzione RF max 20m, Selezione colori ed Effetti con Movimento / Statici con Puntini Stelle Galassie etc. fissi / intermittenti, Regolazione Velocità, On-Off Timer 2/4/6/8 ore (escludibile), Corpo e picchetto in Plastica, Accessorio per Fissaggio a parete incluso, Trasformatore 5V, uso Esterno.

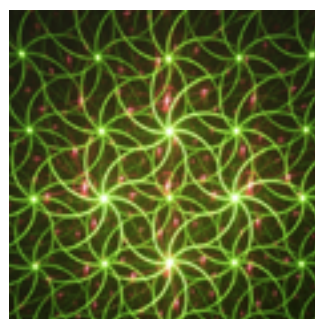

PROIETTORE EFFETTO MOVIMENTO GARDEN LASER VERDE E ROSSO

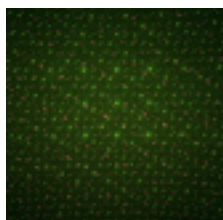

Articolo	Lcm	€ Listino	
9881465	1,8m+Ø11x11xH20/35	53,00	3

• Proiettore GARDEN LASER VERDE & ROSSO, a 15m illumina un'area di Ø15m, Pattern Puntini, vari effetti lampeggianti automatici, Funzione On-Off con Sensore di luminosità, Corpo e picchetto in Plastica, Accessorio Base per Appoggio incluso, Trasformatore 12V, uso Esterno.

PROIETTORE CALEIDOSCOPIO MULTICOLORE GARDEN

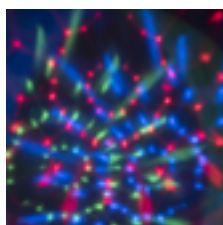

Articolo	Lcm	€ Listino	
9881475	1,8m+Ø9x12xH30/20cm	26,80	3

• Proiettore GARDEN Caleidoscopico 3x1W LED MULTICOLORE, a 5m illumina un'area di Ø6m, Effetto di movimento Rotatorio Automatico, Corpo e base in Plastica con fori per fissaggio a parete / giardino, Trasformatore 12V, uso Esterno, Cavo alimentazione 1,8m

PROIETTORE 12 EFFETTI MODIFICABILI



Articolo	Lcm	€ Listino	
9881470	5m+Ø11x19xH34,5	103,20	2

• Proiettore GARDEN "Oscar" 12 Soggetti intercambiabili 4x3W LED BIANCO, 12 diversi soggetti intercambiabili da proiettare, a 15m illumina un'area di Ø12m. Effetto di movimento Rotatorio Automatico. Corpo e picchetto in Plastica ed Alluminio. Accessorio Base appoggio / fissaggio in plastica incluso. Trasformatore 24V, uso Esterno. Dimensioni 5m+Ø11x19xH34,5c

CATENA 400 LUCI LED GIALLA FISSA

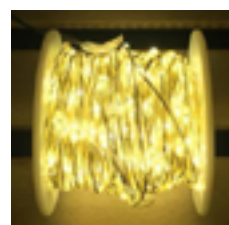

Articolo	€ Listino	
9881480	42,70	3

• Catena lineare 400 MicroLED CLASSIC Ø1,5mm, Luce Fissa, Trasformatore 12V, uso Esterno e Interno, Cavo Metallo Argento Metal Silver, Dimensioni 4+20m, Bobina in plastica rigida inclusa.

Per informazioni tecniche, foto e prezzi aggiornati visita il nostro sito www.cillisrl.com

**PROGRAMMATORE DA
PRESA 96 INTERVALLI**



Articolo	€ Listino	
9940177	4,67	1

**ADATTATORE TRIPLO
1 SCHUKO 2 UNIVERSALI**



Articolo	€ Listino	
9940186	1,89	1

**ADATTATORE TRIPLO
UNIVERSALE PICCOLO**



Articolo	€ Listino	
9940192	1,30	1

**ADATTATORE QUADRUPLO
GRANDE**



Articolo	€ Listino	
9940194	2,43	1

**ADATTATORE TRIPLO
1 SCHUKO 2 PRESE PICCOLE**



Articolo	€ Listino	
9940188	1,89	1

**ADATTATORE TRIPLO
UNIVERSALE GRANDE**



Articolo	€ Listino
9940190	1,56

1

**ADATTATORE SINGOLO
SCHUKO SPINA GRANDE**



Articolo	€ Listino	
9940196	1,30	1

**PRESA MULTIPLA
4 POSTI UNIVERSALI**



Articolo	€ Listino	
9940182	7,70	1

PROLUNGA 6 METRI BIANCA



Articolo	€ Listino	
9940165	6,88	1

PROLUNGA 3 METRI BIANCA



Articolo	€ Listino	
9940179	4,26	1

**PROLUNGA 10 METRI
SHUKO PER ESTERNO**



Articolo	€ Listino	
9940180	20,48	1



Per informazioni tecniche, foto e prezzi aggiornati visita il nostro sito www.cillisrl.com



ASSORTIMENTO FASCETTE CABLAGGIO A NORME CE

• Kit 75 fascette cablaggio assortite:
25 fascette lunghezza 90 mm
25 fascette lunghezza 120 mm
25 fascette lunghezza 150 mm



Articolo	Lmm	€ Listino	
9819575	25x90-120-150	0,64	100



KIT 100 FASCETTE PER CABLAGGIO NERE A NORME CE

• Kit 100 pz - Fascette cablaggio fermacavi fascetta stringi cavo



Articolo	Lmm	€ Listino	
0455303	100x2,5	0,78	100
0455360	140x3,5	1,87	100
0455355	150x2,5	1,15	100
0455311	150x4,8	3,00	100
0455365	200x3,5	2,40	100
0455312	200x4,8	3,50	100
0455313	250x5,0	4,30	100
0455370	300x3,6	3,56	100
0455315	300x5,0	4,80	100
0455325	300x7,5	9,00	100
0455375	365x4,5	5,83	100
0455380	430x4,6	7,29	100
0455385	450x7,6	12,44	100
0455390	550x7,6	16,85	100



KIT 100 FASCETTE PER CABLAGGIO VERDI A NORME CE

• Kit 100 pz - Fascette cablaggio fermacavi fascetta stringi cavo



Articolo	Lmm	€ Listino	
0455400	140x3,5	2,01	100
0455405	200x3,5	2,59	100
0455410	200x4,8	3,46	100
0455415	300x4,5	5,14	100

NASTRO ELETTRICO PROFESSIONALE



Articolo	Lmm	Colore	€ Listino	
3150105	15x10 mt	Nero	0,57	200
3150110	15x10 mt	Verde	0,57	200
3150120	15x10 mt	Giallo	0,57	200
3150130	15x10 mt	Rosso	0,57	200
3150140	15x10 mt	Grigio	0,57	200

NASTRO PVC PROFESSIONALE PER ELETTRICISTI ED INNESTI NERO

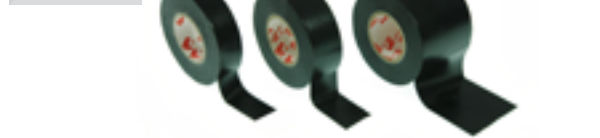

Articolo	Lmm	€ Listino	
3150200	19x25 mt	1,56	120
3150300	25x25 mt	1,96	96
3150350	30x25 mt	2,24	72
3150380	38x25 mt	2,79	60
3150400	50x25 mt	3,72	48

NASTRO AUTOGLOMERANTE PROFESSIONALE



Articolo	Lmm	€ Listino	
3150850	19x9,5 mt	4,32	48

NASTRO CARROZZIERE



Articolo	Lmm	€ Listino	
3150880	38x50 mt	2,14	48
3150885	50x50 mt	2,68	36

NASTRO AMERICANO PROFESSIONALE



Articolo	Lmm	€ Listino	
3150800	50x25 mt	6,60	36

NASTRO ADESIVO FRAGILE



Articolo	Lmm	€ Listino	
3150730	50x66 mt	2,80	36

NASTRO PER SERRE



Articolo	Lmm	€ Listino	
3150815	100x25 mt	14,50	18

NASTRO ADESIVO FRAGILE



Articolo	Lmm	€ Listino	
3150730	50x66 mt	2,80	36



Per informazioni tecniche, foto e prezzi aggiornati visita il nostro sito www.cillisrl.com

NASTRO ADESIVO



Articolo	Lmm	Colore	€ Listino	
3150710	50x50 mt	Avana	1,38	36
3150715	50x50 mt	Bianco	1,38	36
3150720	50x50 mt	Trasparente	1,38	36

NASTRO SEGNALETICO BIANCO-ROSSO



Articolo	Lmm	€ Listino	
3152000	70x200 mt	3,84	36

BOBINA FILM TRASPARENTE ESTENSIBILE h500mm SP 23 MY



Articolo		€ Listino	
3150907	2,4	13,00	6

Prezzo riferito ad una bobina

ESPOSITORE VUOTO CILLI EXTRA



Articolo	€ Listino	
9764035	238,00	1

• Dimensioni: 100cmx45cmxh200cm
Incluso 1 set da 20 ganci: 15pz singoli 250mm + 5pz doppi 250mm



CASALINGHI



Per informazioni tecniche, foto e prezzi aggiornati visita il nostro sito www.cillisrl.com

TORCHIETTO PICCOLO INOX



Articolo	€ Listino	
6001309	28,02	4

TORCHIETTO MEDIO INOX



Articolo	€ Listino	
6001307	40,80	4

TORCHIETTO GRANDE INOX



Articolo	€ Listino	
6001305	70,72	2

TORCHIETTO CON BICCHIERE E FILTRO IN ACCIAIO INOX



Articolo	Lcm	Lt	€ Listino	
6001301	14	3	42,70	3
6001303	20	4,2	88,14	3

SCHIACCIA PATATE INOX



Articolo	Fori	€ Listino	
6001322	2,5 mm	13,92	6



ESTRATTORE DI SUCCHI



Articolo	€ Listino	
6001410	170,00	1

• Schiacciapatate in acciaio inox di elevato spessore con bicchiere inox 18/10.

artus

**ACCESSORIO ESTRATTORE
SUCCHI PER MOTORI REBER N°3**



Articolo	€ Listino	
6001415	50,00	1

cilli

**PASSATUTTO IN PLASTICA
CON PARTICOLARI IN ACCIAIO INOX**



Articolo	Lcm	€ Listino	
6001316	20	6,50	6
6001318	24	8,20	6

**PASSATUTTO IN ACCIAIO
INOX 18/10**



Articolo	Lcm	€ Listino	
6001312	20	15,16	6
6001314	24	19,74	6

• Con tre filtri intercambiabili e tre piedini pieghevoli.

COLAPOMODORO MANICO LUNGO



Articolo	€ Listino	
6001306	8,90	20

**PESTELLO PLASTICA
PER SPREMIPOMODORO O TRITACARNE**



Articolo	€ Listino	
6001241	5,44	4

SPREMIPOMODORO INOX



Articolo	Lcm	€ Listino	
6001271	17x22,5x30	29,12	4

• Spremipomodoro in acciaio inox con guarnizione salvatavolo in plastica e morsetto per il fissaggio.



ESSICCATORE PROFESSIONALE GHIBLI

Articolo	€ Listino	
8001676	271,00	1

eco-contributo raee € 0,21+IVA

CARATTERISTICHE

Tensione di alimentazione	200/230V
Consumo	550/1100W
Capienza Kg	1,7 / 2,5 / 3,75
Capacità indicativa per cassetto	750 gr di frutta, 350/500 gr di verdura



PAIOLO IN RAME CON MESCOLATORE 7 LT

Articolo	Lmm	€ Listino	
6001310	300	145,24	1

eco-contributo raee € 0,14+IVA



KIT FORMAGGIO CON TERMOMETRO INOX

•Produrre il formaggio è semplicissimo, soprattutto con questo kit, perchè è indubbiamente il più completo del mercato.

Il kit contiene:

- 1 Vaschetta forata per la stagionatura (misura perfetta anche per il frigorifero)
- 1 Vaschetta per cagliata
- 1 Coperchio utilizzabile per le due vaschette
- 1 Griglia per scolo formine e stagionatura
- 1 Paletta 40 cm
- 1 Termometro sonda Innox
- 1 Taglia caglio
- 7 Formine per caciotta
- 4 Formine per ricotta
- 1 Caglio di vitello
- 1 Metabisolfito 250 gr. (Disinfettante)
- 1 Cloruro di calcio
- 1 Sale confezione da 200 gr.
- 1 Libricino ricette per produrre tutti i tipi di formaggio con i prodotti Vik Cheese

Articolo	€ Listino	
0037305	110,00	2



FORMETTA FORMAGGIO



Articolo	Lcm	€ Listino	
0037306	15,2x15	4,22	1
0037307	20x9,7	5,55	1

FORMETTA FORMAGGIO-RICOTTA PERDERE CON BORDO



Articolo	Lcm	€ Listino	
0037308	9,5x7	0,27	1

FORMETTA CACIOTTA



Articolo	Lcm	€ Listino	
0037309	9x5,2	0,68	1

FORMETTA FUSCELLA QUADRATA



Articolo	Lcm	€ Listino	
0037310	10,5x8,5	1,40	1

KIT LIQUORE ESSENZA SAMBUCA

•Il kit contiene:

- 1 Dispenser vetro lt.3
- 1 Provetta 26,5
- 1 Alcolometro
- 1 Imbuto ø 8
- 1 Cilindro graduato 100 cc.
- 1 Paletta Cocktail
- 2 Essenze da 20 ml.

Articolo	€ Listino	
0003010	67,60	2



KIT BIRRA PLATINUM CON TAPPATRICE E AVVINATORE

•Il kit contiene:

- 2 Secchi
- 1 Gommino
- 1 Rubinetto
- 1 Air lock
- 1 Paletta da birra
- 1 Provetta 26,5 H.
- 1 Densimetro
- 1 Avvinatore eco
- 1 Tappi corona Ø26
- 1 Travasatore da birra
- 1 Scatola
- 1 Termometro cristalli
- 1 Metabisolfito
- 1 Spazzolino lavabottiglie
- 1 Dosa zucchero
- 1 Tappatrice colonna corona

Articolo	€ Listino	
0003005	111,52	2



Per informazioni tecniche, foto e prezzi aggiornati visita il nostro sito www.cillisrl.com

MALTO BIRRA LAGER BIONDA PER KIT BIRRA PLATINUM

• Malto preparato per produrre 23 litri di birra "LAGER" dal corpo delicato e soffice, il generoso uso di luppolo la rende dissetante e gustosa per tutti i palati. La confezione contiene il suo specifico lievito secco. Per un'ottima degustazione dei suoi aromi si consiglia di servirla a una temperatura di circa 8 gradi.



Articolo		€ Listino	
0003007	1,5	23,68	3

BILANCIA



Articolo	Portata	€ Listino	
9860912	12 Kg	2,40	24
9860925	25 Kg	3,50	24
9860930	50 Kg	4,00	24
9860940	100 Kg	6,00	24

BILANCIA



Articolo	Portata	€ Listino	
9860950	150 kg	15,00	12

SET 100 BUSTE SOTTOVUOTO GOFFRATE SU UN LATO



Articolo	Lcm	€ Listino	
5170345	12x20	5,30	32

• Per Alimenti conforme al D.M. 21.03.73 e successivi aggiornamenti.



SET 50 BUSTE SOTTOVUOTO GOFFRATE SU UN LATO



Articolo	Lcm	€ Listino	
5170350	15x25	3,54	48
5170355	10x53	7,14	18
5170360	20x30	5,70	32
5170370	25x35	7,90	18
5170380	30x40	10,80	14

• Per Alimenti conforme al D.M. 21.03.73 e successivi aggiornamenti.



COLTELLO SCANNO LAMA INOX



PRO

Articolo	Lcm	€ Listino	
9702215	18	5,60	24

COLTELLO CUCINA LAMA INOX



PRO

Articolo	Lcm	€ Listino	
9702415	16	5,00	24
9702416	22	6,00	24

COLTELLO SVIZZERO LAMA INOX



PRO

Articolo	Lcm	€ Listino	
9702226	20	6,50	24
9702227	25	7,50	24

COLTELLO PANE LAMA INOX



PRO

Articolo	Lcm	€ Listino	
9702425	30	5,80	24

MANNARETTA LAMA INOX



PRO

Articolo	Lcm	€ Listino	
9702280	18x0,4	13,80	24

AFFILA COLTELLI FORBICI E UTENSILI TAGLIO DELUX



PRO

Articolo	Lcm	€ Listino	
9860055	30	12,00	30

SET 4 COLTELLI IN CERAMICA LAMA BLACK



Articolo	€ Listino	
9702450	45,00	2

SET 3 FORBICI INOX



Articolo	Lcm	€ Listino	
9863328	25-21-14	7,60	24

Per informazioni tecniche, foto e prezzi aggiornati visita il nostro sito www.cillisrl.com

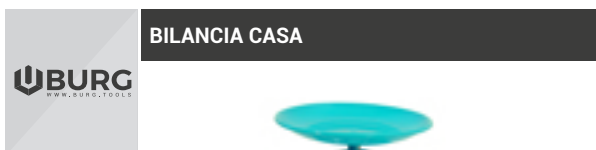

BILANCIA CASA



Articolo	Portata	€ Listino	
9860990	2 kg	8,50	12

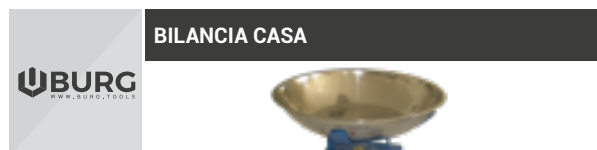

BILANCIA CASA



Articolo	Portata	€ Listino	
9860998	5 Kg	26,00	6
9860991	15 Kg	30,00	6
9860993	20 Kg	30,00	6
9860995	30 Kg	33,00	6



FORNELLINO A GAS PIEZO



Articolo	€ Listino	
9998785	19,20	12



FORNELLO 2 FUOCHI



Articolo	Lcm	€ Listino	
9998372	52x72x32	42,46	6



FORNELLO PIEZO 3 FUOCHI



Articolo	Lcm	€ Listino	
9998376	50x30x10	60,00	6

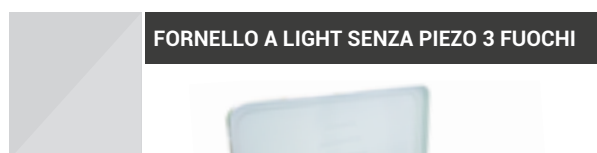

FORNELLO A LIGHT SENZA PIEZO 3 FUOCHI



Articolo	€ Listino	
9998378	44,80	6

• Non adatto a cotture oltre 20 minuti

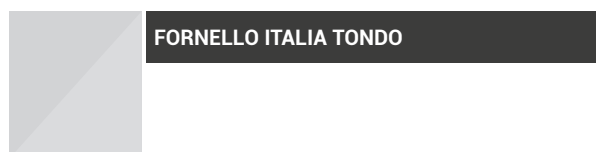

FORNELLO ITALIA TONDO



Articolo	Ø	€ Listino	
9998359	48x21	43,52	2





**FORNELLONE DA CAMPAGNA 27x27CM
A NORME CE PER USO ESTERNO**

Articolo	Lcm	kg	€ Listino	CFM
9998340	27x27x12	1,900	21,00	2



FORNELLONE INOX AISI 430 CE

Articolo	Lcm	kg	€ Listino	CFM
9998345	40x40x19	5,000	47,20	2



FORNELLONE ITALIA DA CAMPAGNA

Articolo	Lcm	€ Listino	
9998355	40x40x14,5	25,84	2
9998358	45x45x14,5	32,00	2



**ROTOLO TUBO 100MT GAS GPL CERTIFICATO
IEMMEQU UNI-CIG 7140**

- Omologato IMQ. Tubo in PVC flessibile con rinforzo retinato in poliestere ad alta tenacità. Prodotto con speciale formulazione che conferisce

resistenza all'usura da passaggio di GPL.
Resiste agli agenti atmosferici, all'invecchiamento e al contatto accidentale con oggetti caldi.
Conforme alle norme UNI/CIG 7140/72 e successivi aggiornamenti per la sicurezza delle apparecchiature a gas.
Applicazioni: apparecchiature domestiche a gas.

Articolo	Lmm	€ Listino	
0651008	8x13	66,54	1



Per informazioni tecniche, foto e prezzi aggiornati visita il nostro sito www.cillisrl.com



**REGOLATORE BASSA PRESSIONE
A NORME CE ORIZZONTALE**



Articolo	Portata	€ Listino	
9998260	1,5 kg/ora di gas gpl	4,44	24

• Pressione erogata regolabile: 30-60 mbar



REGOLATORE ALTA PRESSIONE A NORME CE



Articolo	Portata	€ Listino	
9998280	6 kg/ora di gas gpl	10,60	24

• Pressione erogata regolabile: 0-4 mbar



**RACCORDO PORTAGOMMA
PER BOMBOLA A GAS**



Articolo	€ Listino	
9998230	2,60	24



RACCORDO A TRE VIE



Articolo	Ø	€ Listino	
9998220	8 mm	2,32	24

VENTILATORE A COLONNA

- Ventilatore a colonna a 3 velocità.
- Rotazione automatica.
- Diametro ventola 40. Ultra silenzioso.
- Altezza regolabile max 126 cm.
- Griglia di protezione alveare per una sicurezza totale pale orientabili verticalmente.

Articolo		€ Listino	
5230000	H126 45W	33,52	3

VENTILATORE DA TAVOLO

- Ventilatore da tavolo a 2 velocità.
- Rotazione automatica.
- Diametro ventola 23. Ultra silenzioso.
- Griglia di protezione alveare per una sicurezza totale pale orientabili verticalmente.

Articolo		€ Listino	
5230015	Ø 23 22W	25,08	3

VENTILATORE DA TAVOLO

- Ventilatore da tavolo a 3 velocità.
- Rotazione automatica.
- Diametro ventola 30. Ultra silenzioso.
- Griglia di protezione alveare per una sicurezza totale pale orientabili verticalmente.

Articolo		€ Listino	
5230010		30,14	3

VENTILATORE DA TAVOLO

- Ventilatore da tavolo a 3 velocità.
- Rotazione automatica.
- Diametro ventola 40. Ultra silenzioso.
- Griglia di protezione alveare per una sicurezza totale pale orientabili verticalmente.

Articolo		€ Listino	
5230005	Ø 40 45W	33,52	3



CATALOGO LISTINO
2020

cilli

www.cillisrl.com



Uffici e Magazzini: V.le Australia, 11
66050 San Salvo (CH) - ITALY
Tel. 0873 547570 Fax. 0873 341884
ordini@cillisrl.it